

承 认 书
SPECIFICATION FOR APPROVAL

客户名称 Customer: _____

贵司料号CUSTOMER P/N: _____

敝司料号INTERIOR P/N: WTD01WXXXXXX

贵公司承认印 Approval signatures

料号/Part No.	签章/Signatures

Send us a copy of reference, thank you!

日期 Date:

地址: 浙江省乐清市虹桥镇信岙工业区
Add: Xinao Industry Zone Hongqiao Yueqing
Zhejiang
电话/Tel: 86-0577-57573366
传真/Fax: 86-0577-57573373
Http://www.cnbozhong.com
Alibaba: Http://dezhimei.cn.alibaba.com

拟制/Drawn	朱光隆
审核/Check	陈乐峰
批准/Approved	陈乐峰



WTD01WXXXXXX

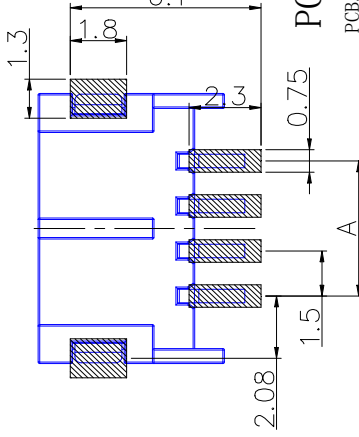
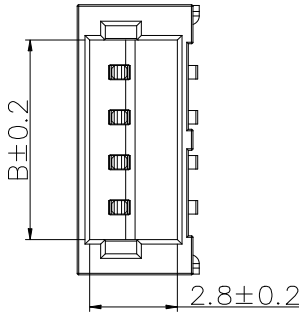
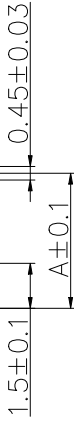
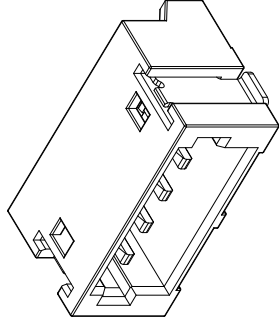
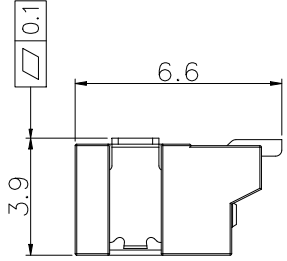
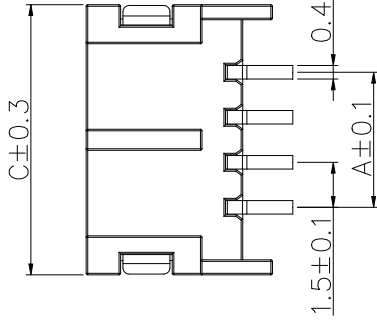

PCB. 焊接图
PCB. WELDING DRAWING

- 极数 Number of poles: 2-16
- 工作温度 Working Temperature: -25℃~+85℃
- 额定电压 Voltage rating : 125V AC
- 额定电流 Rated current : 1.0A
- 接触电阻 Contact resistance: ≤0.03Ω
- 绝缘电阻 Insulation resistance: ≥100MΩ
- 耐压 Withstand voltage : 250V AC
- 端子 Terminal : 铜合金 Copper Alloy
外壳 Housing : LCP

	A	B	C
2P	1.5	3.65	6.0
3P	3.0	5.15	7.5
4P	4.5	6.65	9.0
5P	6.0	8.15	10.5
6P	7.5	9.65	12.0
7P	9.0	11.15	13.5
8P	10.5	12.65	15.0
•••••	•••••	•••••	•••••

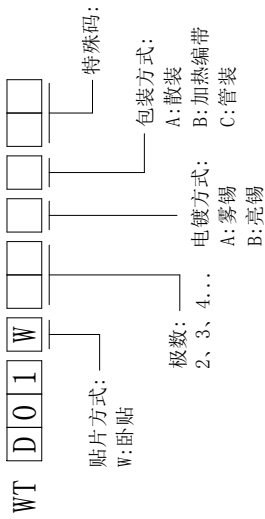

第一视角
FIRST VIEW



标记 SIGN.	体数 FREQUENCY	设计 DESIGN	审核 CHECKED	批准 APPROVED	日期 DATE	任务 APPROVED	日期 DATE	比例 SCALE	一般公差 GENERAL TOLERANCE	名称/NAME:
								1:1	±0.20	针座
设计	朱元隆	2021.06.01	赵晓峰	2021.06.01				mm	≥0-2<	型号/MODEL:
审核	陈乐峰	2021.06.01	陈乐峰	2021.06.01				UNIT	≥2-5<	WTD01WXXXXXX
批准								WEIGHT	≥5	BZCN 浙江博众电气有限公司 ZHEJIANG BOZHONG ELECTRONIC CO., LTD.
									角度 ANGLE	
									±0.50	
									±0.5°	

SPECIFICATION

1、适用范围

APPLICATION

此规格书适用于线对板连接器的相关要求

This specification is applicable to relevant requirements of wire to board connector

2、使用条件

SERVICE CONDITIONS

2.1 环境温度: -25℃~+85℃

Ambient temperature Range: -25℃~+85℃

3、外观及尺寸

Appearance and Dimension

3.1 产品表面不应有对制品有害的缺陷、污垢、裂痕及机械损伤; 接触件无锈蚀、镀层氧化、脱落等现象

Appearance: Product surface without defect, dirt, crack, and mechanical damage,

Contact without rust, plating not oxidized and not peeled

3.2 外形尺寸: 参考图纸

Dimension: According to drawings

4、材料

Material

名称 NAME	材质 MATERIALS
主体 Main body	LCP (本色)
端子 Solder tabs	铜合金
焊护耳 Solder tabs	铜合金

5、电气性能

Electrical Performance

NO.	项目 ITEM	试验条件 TEST CONDITIONS	要求 REQUIREMENTS
5.1	接触电阻 Contact Resistance	适合嵌合状态; 开放电压20mV 以下; 短路电流 10mA的状态下测定。 Mate applicable and measure by dry circuit, 30mΩ MAX, 10mA	≤ 30mΩ MAX

SPECIFICATION

5.2	绝缘电阻 Insulation Resistance	适合嵌合状态；相邻端子间或端子与地面间加DC 100V下测定。 Mate applicable and apply 100V DC between adjacent terminal or ground.	$\geq 100M\Omega$
5.3	耐电压 Dielectric	适合嵌合状态；相邻端子间或端子与地面间加AC500V（有效值）历时1分钟下测定。 Mate applicable and apply 500V AC(rms)for 1minute between adjacent terminal or ground.	无击穿、无飞弧 There should be no breakdown and flashover

6、 机械性能：

MECHANICAL SPECIFICATION

NO.	项目 ITEM	试验条件 TEST CONDITIONS	要求 REQUIREMENTS
6.1	端子保持力 Terminal Retention Force	单一端子；以每分钟 $25\pm 3mm$ 的速度平行向外拉 Pull the terminal at the speed rate of $25\pm 3mm$ per minute	$\geq 1.96N$

SPECIFICATION

7、 环境和其他性能:

ENVIRONMENTAL PERFORMANCE AND OTHERS

NO.	项目 ITEM	试验条件 TEST CONDITIONS	要求 REQUIREMENTS
7.1	重复拔插 Repeated Insertion and Withdrawal	无通电状态; 以10次/分钟的速度插拔20次 Insertion and withdrawal catuator up to 20 cycles at the speed rate of less than 10 cyclea/minute	试验后接触电阻 ≤ 60mΩ
7.2	温度上升 Temperature Rise	适合嵌合状态; 最大容许电流通电, 温度测定。 Carrying rated current load.	试验后温度上升 ≤ 30℃
7.3	耐热性 Heat Resistance	适合嵌合状态; 85±2℃的空气中; 放置 96 小时; 再回到室温中放置 1-2 小时 85±2℃, 96 hour	试验后外观无损坏, 接触电阻 ≤ 60mΩ

SPECIFICATION

<p>7.4</p>	<p>耐寒性 Cold Resistance</p>	<p>适合嵌合状态：-40±2℃的空气中；放置 96 小时；再回到室温中放置 1-2 小时 -40±2℃， 96 hour</p>	<p>试验后外观无损坏， 接触电阻 ≤ 60mΩ</p>
<p>7.5</p>	<p>耐湿性 Humidity</p>	<p>适合嵌合状态； 40±2℃、相对湿度90-95%的空气中；放置 96 小时；再回到室温中 0.5 小时内测定 Temperature: 40±2℃ Relative Humidity: 90-95% Duration: 96 Hours</p>	<p>试验后外观无损坏， 接触电阻 ≤ 60mΩ 满足耐电压测试， 绝缘电阻 ≥ 20MΩ</p>
<p>7.6</p>	<p>温度循环 Temperature Cycling</p>	<p>适合嵌合状态； -25±3℃ 30 分钟；常温常湿 10-15 分钟； 85±2℃ 30 分钟；常温常湿 10-15 分钟，循环5次。 5 cycles of: a) -25±3℃ 30 minutes B) 85±2℃ 30 minutes</p>	<p>试验后外观无损坏， 接触电阻 ≤ 60mΩ</p>

SPECIFICATION

<p>7.7</p>	<p>盐雾试验 Salt Mist (铁材质不做盐雾要求)</p>	<p>在嵌合状态以下列设定条件下进行测量: The switch shall be checked after following test: (1) 温度: 35°C±2°C temperature: 35°C±2°C (2) 盐溶液浓度: 5±1% (质量百分比) salt solution : 5±1%(solids by mass) (3) 时间: 24h Time: 24h 实验后的盐沉积物后水冲掉 After test, salt deposit shall be removed by running water.</p>	<p>金属件上没有腐蚀斑点 No remarkable corrosion shall be recognized in metal part.</p>
<p>7.8</p>	<p>可焊性 Solderability</p>	<p>端子前端侵入 235±5°C的锡槽中; 历时 2±0.5 sec. Soldering Time: 2±0.5 sec. Soldering Temperature: 235±5°C 0.2 mm from terminal tip</p>	<p>除边缘外涂层应均匀覆盖 90%以上 Except for the edge, the coating should cover a minimum 90%</p>

下图为所推荐的回流焊温度曲线图

The following diagram shows the recommended reflow soldering temperature profile.



X-ON Electronics

Largest Supplier of Electrical and Electronic Components

Click to view similar products for [Headers & Wire Housings](#) category:

Click to view products by [Bozhong Electric](#) manufacturer:

Other Similar products are found below :

[0015917161](#) [0022155065](#) [57102-F02-18ULF](#) [58102-G61-06LF](#) [582553-1](#) [01.001.5753.1](#) [0050291907](#) [02.125.8002.8](#) [609-3404](#) [61062-3](#)
[CSU011177004](#) [622-0430](#) [622-3653LF](#) [63453-116](#) [636-1030](#) [636-1427](#) [636-3427](#) [636-4007](#) [641938-9](#) [65495-038](#) [65692-001LF](#) [65781-018](#)
[65781-047](#) [65817-010LF](#) [65817-015LF](#) [67095-007LF](#) [67601157](#) [68631-112](#) [68645-018](#) [699319-000](#) [70.362.1628.0](#) [70-4210](#) [70-4226B](#) [70-](#)
[4853B](#) [71.350.2428.0](#) [733-134](#) [733-162](#) [760-3052](#) [MHR-64-VUAL](#) [80.063.4001.1](#) [800-90-001-10-001000](#) [801-43-002-10-013000](#)
[801-43-006-10-002000](#) [803-43-024-10-001000](#) [803-93-012-10-001000](#) [8-1437020-4](#) [819-22-004-30-001101](#) [820-22-006-30-001101](#)
[820-22-008-30-001101](#) [821-22-002-10-001101](#)