

# SW-125 Embedded Industrial 5 Port PoE+ Ethernet Switch

5 Port (Ports 1-4 PoE+) Unmanaged 10/100 Ethernet Switch

- 5 port PoE+ 10/100 Fast Ethernet device
- Ports 1-4 PoE+ capable
- Fully compliant to IEEE 802.3af/at
- PoE Power Budget: 90W @ 70°C
- Industrial temp range: -40°C to +70°C
- Redundant dual power inputs: +44V to +57V DC
- Compact, embeddable design
- Allows power and data to be combined on the same Ethernet cable

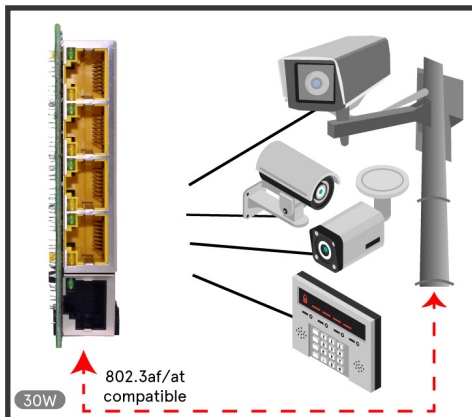
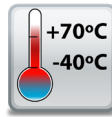
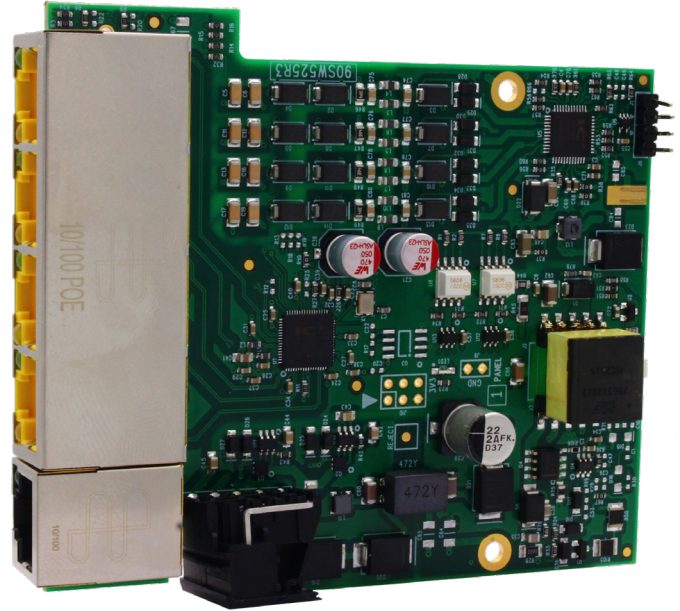

Send power and data to remote CCTV cameras, PoE telephones, PoE Wifi access points, NVRs, and more



Embedded format, takes up minimal space, with mounting holes connected to Functional Earth



Provides additional Ethernet ports for your custom application

## SW-125

## Embedded Industrial 5 Port PoE+ Ethernet Switch

90W PoE Power Budget shared  
 between 4 Ethernet Ports

-40°C to +70°C/-40°F to +158°F  
 temperature range

Ports 1-4 IEEE 802.3af/  
 at compliant: deliver  
 up to 30W to each port  
 (backwards compatible)

Automatic detection of  
 data transmission speed:  
 10 or 100 MBps

2k Byte maximum packet size -  
 improves the efficiency of bulk data  
 transfer and system performance

Easy Wire Removable screw  
 terminal block

Dual redundant power input:  
 +44VDC to +57VDC

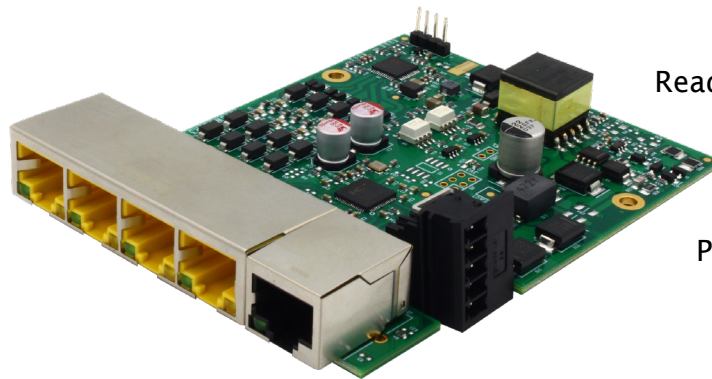

Ready for embedded applications

Power consumption is optimised  
 based on the status of the link  
 device

### Connectors

Screw Terminals

3.5mm pitch, #22 - #14, 0.5mm<sup>2</sup>-2.5mm<sup>2</sup> pin power supply

Wire Thickness

0.150 inch, 3.81mm, 20 pins, 12+8 screw terminals, #26 - #16 AWG,  
 0.14mm<sup>2</sup>-1.3mm<sup>2</sup>

### Power Supply

Power Consumption

4 Watts Max : 91mAmps@+44VDC/70mAmps@+57VDC

PoE Power Budget

90W @ 70°C

Power Supply input

Unregulated +44V to +57Volts DC, reverse polarity protection

Isolation

1500VRMS Magnetic isolation from Ethernet

### Environmental

Operating Temperature

-40°C to +70°C/-40°F to +158°F

Storage Temperature

-40°C to +70°C/-40°F to +158°F

Ambient Relative Humidity

5 to 95% (non-condensing)

### Magjack LED Information

Link/Activity LED

Solid green

Connection established

Flashing Green

Data communication

PoE Power LED  
 (Ports 1-4)

Solid Yellow

PoE Power ON

Flashing Yellow

Power Warning

### Ethernet

Ethernet Port

5 x RJ45 jack, 10/100Mhz autosensing, crossover auto sensing (Auto MDIX)

Protection

1,500 Volts magnetic isolation between ports

Housing

This device is uncased for embedded applications  
 The mounting holes are connected to Functional Earth

## SW-125

## Embedded Industrial 5 Port PoE+ Ethernet Switch

All Dimensions in mm

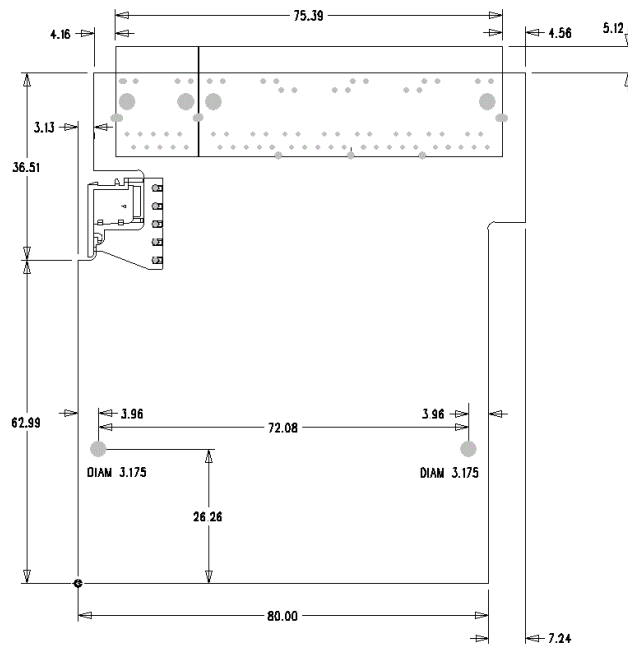

### Ethernet Ports x4 Pin Outs

PoE Pinout 1/2(V+) 3/6(V-) Endspan Mode A

PIN	FUNCTION
1	Tx+ DC+
2	Tx- DC+
3	Rx+ DC-
4	unused
5	unused
6	TRx- DC-
7	unused
8	unused

### Power Terminal Pin Outs

PIN	FUNCTION
1	-V
2	+VA
3	+VB
4	-V

5 position 3.5mm pitch socket compatible with Euroblock pluggable terminal block connectors

5 position 3.5mm pitch pluggable terminal block included

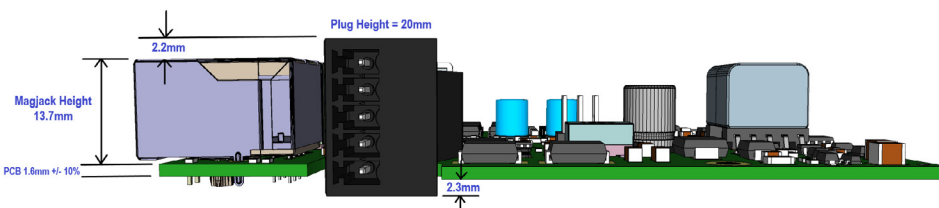
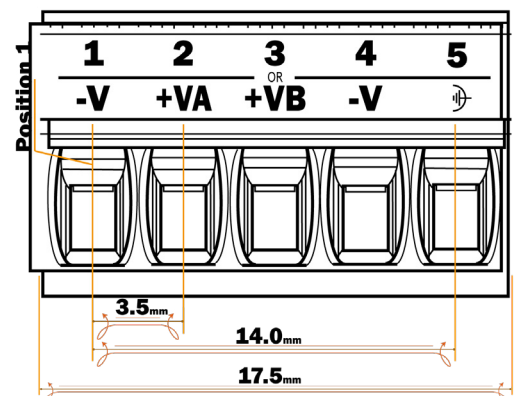

### Lifetime Warranty and Support:

We can help with every aspect of your project, from getting you up and running to custom application.

## SW-125

## Embedded Industrial 5 Port PoE+ Ethernet Switch

### Product Information

Product Weight	0.076 kg, 2.68 ounces
Product Dimensions	100x90x60 mm, 3.9x3.5x2.4 inches

### Packaging Information

Packaging	Quick Start Guide, Device
Packaged Weight	0.226 kg, 7.97 ounces
Packaged Dims	160x135x49 mm, 6.3x5.3x1.9 inches
GTIN Universal Code	837324004588

### Industry Approvals

Industry Approvals	METLABS E112324 complies with UL62368-1, CSA C22.2, No. 62368-1 Microsoft Certified Gold Partner, WEEE, RoHS, AEO (C-TPAT), CE, UKCA
HTS	8517620000
ECCN	5A991.b
CAGE	8QCY6

### Warranty

Warranty	Lifetime - online registration required
Support	Lifetime Web, Email & Phone Support from fully qualified, friendly staff who work in and alongside the Product Development Team

### Standards

Standards	ISO9001, ISO14001
OEM option	Available for bulk buy OEM
COO (Country of Origin)	GB
Made In	Manufactured in GB by Brainboxes
Customisable	Brainboxes operate a 'Perfect Fit Custom Design' policy for volume users More info: <a href="mailto:sales@brainboxes.com">sales@brainboxes.com</a>



PW-323  
PoE Splitter

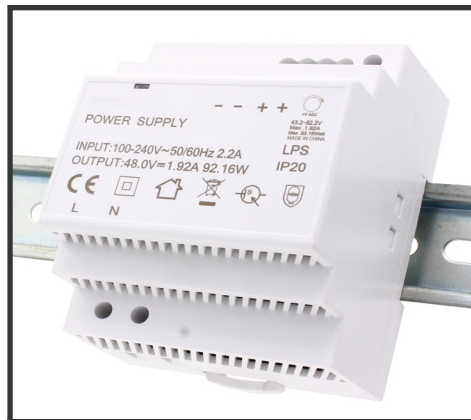

PW-301  
DIN Rail Power Supply



SW Range  
Switch products available in a range of formats and specifications.  
[www.brainboxes.com](http://www.brainboxes.com)

## X-ON Electronics

Largest Supplier of Electrical and Electronic Components

*Click to view similar products for [Ethernet Modules](#) category:*

*Click to view products by [Brainboxes](#) manufacturer:*

Other Similar products are found below :

[TDKEZW3](#) [V23993-USB1029A](#) [100-POE4](#) [X520QDA1](#) [BCM84794A1KFSBG](#) [X520DA2OCP](#) [808-38157](#) [7506GX2](#) [TC EXTENDER 2001](#)  
[ETH-2S](#) [105FX-SC-MDR](#) [110FX2-SC](#) [7000-P3201-P050150](#) [750-451](#) [750-494](#) [750-495](#) [750-501](#) [750-612](#) [750-627](#) [750-643](#) [750-652](#) [750-](#)  
[653/003-000](#) [753-440](#) [753-540](#) [852-1812](#) [852-1813](#) [852-1816](#) [LANTICK PE-0-16](#) [LANTICK PE-16-0](#) [RBMTXLITE-L4X2.X.X.X.X.](#) [EKI-](#)  
[7708E-4F-AE](#) [EKI-7708E-4FP-AE](#) [EKI-7708G-4FP-AE](#) [2352903-2](#) [EKI-2706G-1GFPI-BE](#) [SW-125](#) [7000-74712-4780030](#) [7000-74712-](#)  
[4780060](#) [7000-74712-4780100](#) [7000-74712-4780150](#) [750-331](#) [753-649](#) [852-1200](#) [852-1210](#) [852-1280](#) [PM02TWA](#) [ICR-1601G](#) [BOXER-](#)  
[6641-A1-1110](#) [EKI-7712G-4F-AE](#) [55150](#) [56005](#)