

Serie Medium

300A Nylon Cable Chain with opening frames

Inner height (D) 18 mm

Single link construction with anti-friction single-pin.
Frames opening from inner radius.
Vertical separators available.
The wide frames on out radius offer good protection, when operating horizontally.

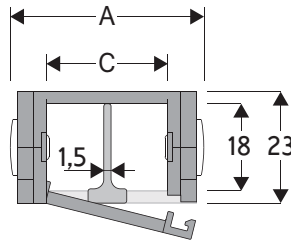

Separator

- Unassembled	Part.no S300A
- Assembled	Part.no S300AMC

Pin

Part.no PG300A

Technical characteristics when self-supported

Speed	10 m/s
Acceleration	50 m/s ²

For higher requirements please consult our technical dept.

A	B	C	D	R	Weight/m	Chain
mm	mm	mm	mm	mm	kg	Part Number
27	23	15	18	040-060-080-120	0,41	300A015 □□□ *
37	23	25	18	040-060-080-120	0,45	300A025 □□□ *
62	23	50	18	040-060-080-120	0,55	300A050 □□□ *
87	23	75	18	040-060-080-120	0,65	300A075 □□□ *

*Complete the code by inserting the value of the radius (R): Ex. 300A015 □ □ □ □

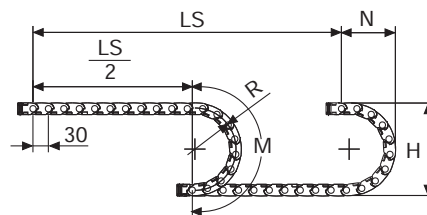

R	H	N	M
mm	mm	mm	mm
040	103	85	185
060	143	105	250
080	183	125	315
120	263	165	440

Length of chain (L)
Half travel distance ($\frac{LS}{2}$)
plus length of curve (M)

$$L = \frac{LS}{2} + M$$



Self-Supporting Capacity Diagram

The maximum length of the self-supporting capacity ($\frac{LS}{2}$) in relationship to the weight of the cables and hoses contained per linear metre.

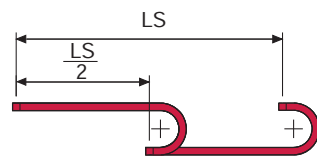
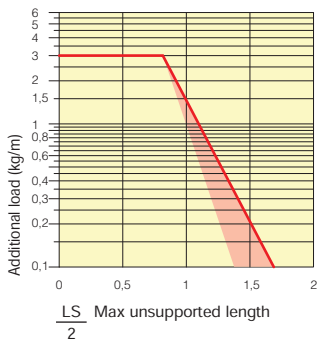

The red marking in the diagram area considers the difference of weight between various widths of chain.

For applications with $\frac{LS}{2}$ and weights not included in the area of the diagram showing self-supporting capacity, verify the possible use of support rollers (see page 30).

End Brackets

The end brackets set allows the two ends of the chain to be attached to the equipment. Set complete with tiewrap clamps available on request.

Nylon Type

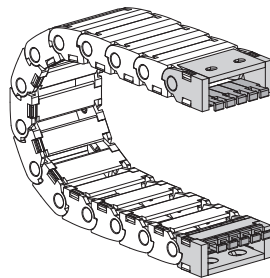

Fig. A Chain fixed outside the radius. (Fig A)

Bright Zinc Plated Steel Type***

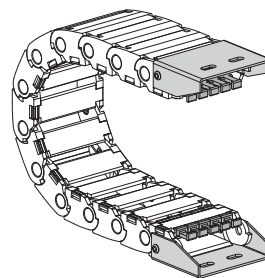
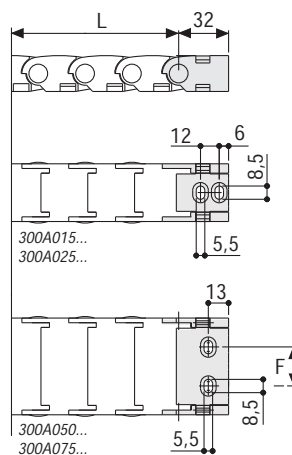

Fig. B Chain fixed outside the radius. (Fig B)
See end brackets mounting variations page 31.



Chain Type	F mm
300A050	25
300A075	50

Nylon Type Part Numbers

Complete Set Assembled Chain Type	End Brackets Set
300A...	AN300A□□□*KM

Complete Set Unassembled Chain Type	End Brackets Set
300A...	AN300A□□□*K

Tiewrap Clamp Part Number
Assembl. CFC300□□□*KM
Unassembl. CFC300□□□*K

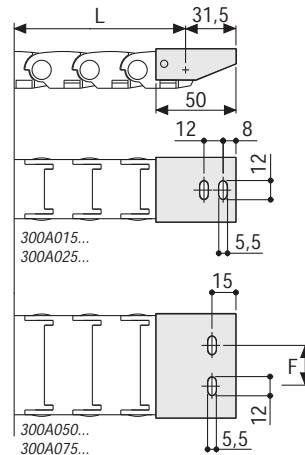

Chain Type	F mm
300A050	25
300A075	50

Bright Zinc Plated Steel Type Part Numbers

Complete Set Assembled Chain Type	End Brackets Set
300A...	A300A□□□*KM

Complete Set Unassembled Chain Type	End Brackets Set
300A...	A300A□□□*K

Tiewrap Clamp Part Number
Assembl. CFC300□□□*KM
Unassembl. CFC300□□□*K

* Inner width (C)
*** Available on request in stainless steel

Serie Medium

300A

Nylon Cable Chain with opening frames



How to open the cover.

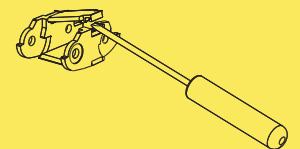
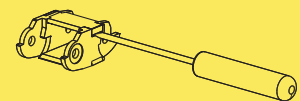

Special tool to remove the connecting pivots:
Part Number PZ010.



For further information please consult Brevetti Stendalto's Technical Office

X-ON Electronics

Largest Supplier of Electrical and Electronic Components

Click to view similar products for [Control Switches](#) category:

Click to view products by [Brevetti](#) manufacturer:

Other Similar products are found below :

[80887-99](#) [80932-99](#) [86855-00](#) [88814-30](#) [1424293-1](#) [HW4S-2TC10](#) [89721-12](#) [89804-08](#) [SSN](#) [RL01801](#) [ASD2L20N-LVO](#) [50051857-17](#)
[50099156-001-05](#) [51.155R-15200](#) [50058920-26](#) [CP-FA51](#) [CP-FA49](#) [ACCU-SC/L-3000](#) [PP9M](#) [PP87G](#) [PP86GA](#) [PP71G](#) [PP70G](#) [PP6G](#)
[PP62G](#) [PP58BL](#) [PP56G](#) [PP86GB](#) [PP77GA](#) [PP76G](#) [PP4M](#) [PP47G](#) [PP46G](#) [PP41M](#) [PP40G](#) [PP32G](#) [RD-20](#) [PP23M](#) [PP12G](#) [PORTAPRO](#)
[POM-2708](#) [PNB-2005](#) [3057.0012](#) [CV-075](#) [CV-140SB](#) [CV-150](#) [CV-150S](#) [214X20XK](#) [CV-180](#) [CV-200MB](#)