

Transformers for printed circuit boards designed chiefly for power supply circuitry assemblies of electronic devices. They feature small dimensions and a compact build as well as having an increased mechanical durability and resilience to climate elements (cast resin). The transformers are made at IP00 protection grade, maximum ambient temperature 60°C, thermal class of insulation B (130°C). Manufactured in compliance with EN 61558-2-1 and EN 61558-2-6.



Rated power: 0,5 - 30VA

Rated voltage PRI: 24 - 500V 50/60Hz

Rated voltage SEC: 6 - 500V

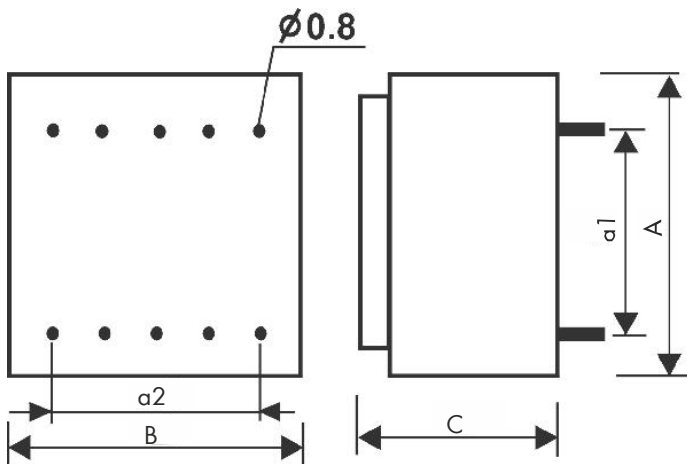

TEZ: 0,5 - 16

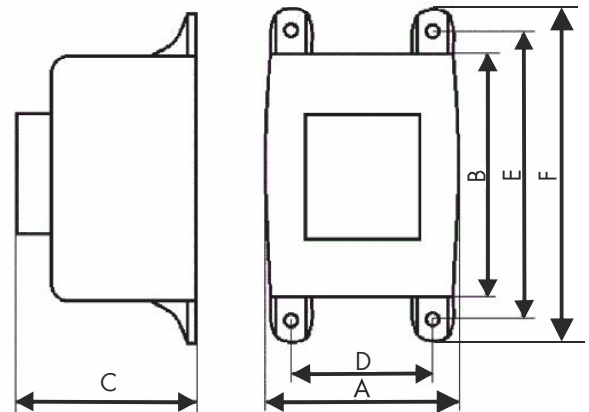

TEZ: 20; 25; 30

Type	Power [VA]	Dimensions [mm]								Weight [kg]	Typical leads		
		A	B	C	a1	a2	D	E	F		PRI	1xSEC	2xSEC
TEZ 0,5	0,5	22	24	19	15	15	x	x	x	0,05	1-4	6-7	5-6, 7-8
TEZ 1,5	1,5	28	33	22	20	20	x	x	x	0,07	1-5	7-9	6-7, 9-10
TEZ 2,0	2,0	28	33	24	20	20	x	x	x	0,09	1-5	7-9	6-7, 9-10
TEZ 2,5	2,5	28	33	27	20	20	x	x	x	0,10	1-5	7-9	6-7, 9-10
TEZ 2,6	2,5	28	33	30	20	20	x	x	x	0,12	1-5	7-9	6-7, 9-10
TEZ 4,0	4,0	35	42	29	25	20	x	x	x	0,15	1-5	7-9	6-7, 9-10
TEZ 4,5	4,5	35	42	29	25	20	x	x	x	0,15	1-5	7-9	6-7, 9-10
TEZ 6,0	6,0	38	45	32	25	25	x	x	x	0,20	1-5	7-9	6-7, 9-10
TEZ 10,0	10,0	44	52	35	27,5	25	x	x	x	0,28	1-6	8-11	7-8, 11-12
TEZ 16,0	16,0	47	57	39	30	30	x	x	x	0,42	1-7	9-13	8-9, 13-14
TEZ 20,0	20,0	53,8	63,6	47,2	32,5	30	43,5	72,5	81,7	0,6	1-7	9-13	8-9, 13-14
TEZ 25,0	25,0	53,8	63,6	51,5	32,5	30	43,5	72,5	81,7	0,7	1-7	9-13	8-9, 13-14
TEZ 30,0	30,0	53,8	63,6	56,5	32,5	30	43,5	72,5	81,7	0,8	1-7	9-13	8-9, 13-14

Because of the constant development of product construction and changes concerning technical requirements, Breve-Tufvassons Company reserves the right to change the parameters mentioned above.

TEZ 0,5

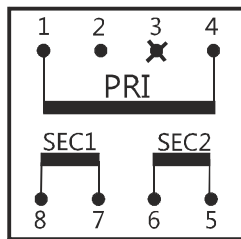
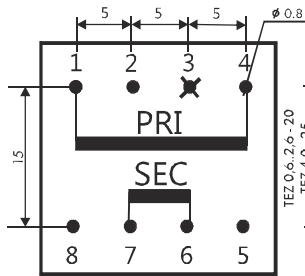

TEZ 0,6 - 4,0

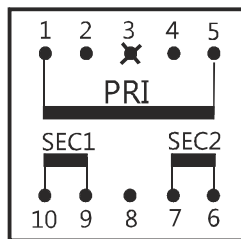
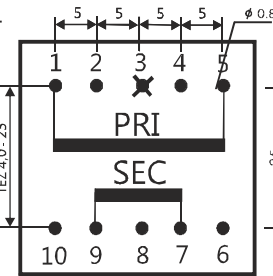

TEZ 6,0

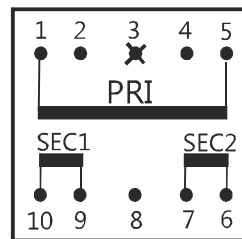
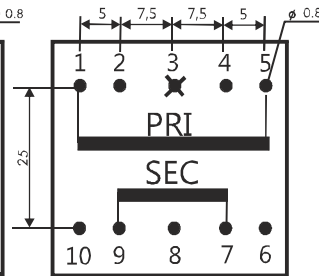

TEZ 10

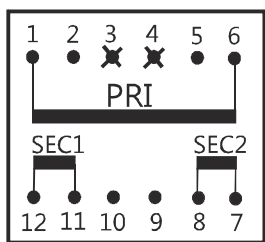
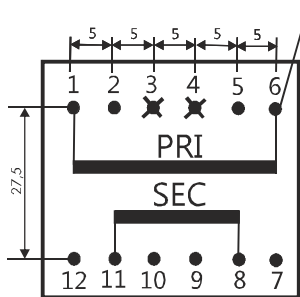

TEZ 16

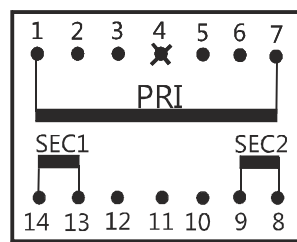
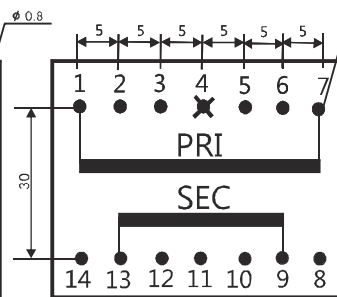

TEZ 20; 25; 30

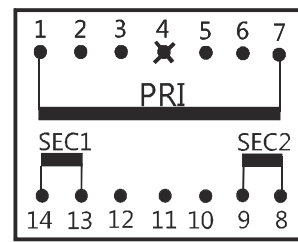
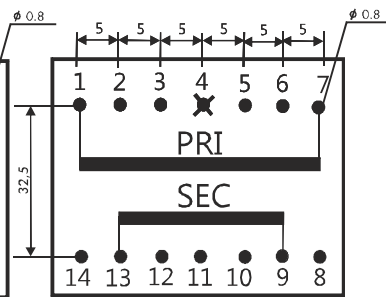

X-ON Electronics

Largest Supplier of Electrical and Electronic Components

Click to view similar products for [Current Transformers](#) category:

Click to view products by [Breve Tufvassons](#) manufacturer:

Other Similar products are found below :

[MP3500](#) [BV UI 302 0156](#) [45029](#) [BV EI 302 2863](#) [BV EI 303 2809](#) [BV EI 303 3060](#) [BV EI 305 2309](#) [BV EI 306 3604](#) [BV EI 481 1295](#) [BV EI 481 1325](#) [BV UI 301 0133](#) [BV UI 302 0144](#) [BV UI 302 0161](#) [BV UI 304 0019](#) [BV UI 304 0129](#) [BV UI 304 0159](#) [BV UI 304 0173](#) [TI-EF16-2X4V-4W](#) [SPCT62/40150/5AVA3CL1](#) [SPCT62/30100/5AVA1CL1](#) [SPCT62/3075/5AVA1CL3](#) [SPCT62/40150/5AVA1.5CL1](#) [SPCT62/40200/5AVA2.5CL0.5](#) [SPCT62/40300/5AVA3CL0.5](#) [CTD-KIT](#) [44013](#) [44017](#) [44021](#) [44098](#) [44101](#) [44134](#) [44171](#) [44174](#) [44178](#) [44180](#) [44248](#) [44250](#) [44278](#) [44339](#) [44340](#) [44373](#) [44375](#) [44376](#) [44378](#) [44379](#) [44436](#) [44831](#) [B82801B0925A200](#) [PA3655NL](#) [PA3828NL](#)