

Bridgelux® Vero® 10 Array Series

Product Data Sheet DS30



BXRC-27x1000

30x1000

35x1000

40x1000

50x1000

Introduction

Vero

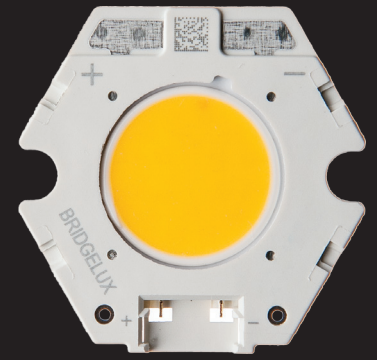

Vero represents a revolutionary advancement in chip on board (COB) light source technology and innovation. Vero LED light sources simplify luminaire design and manufacturing processes, improve light quality, and define a platform for future functionality integration.

Vero is available in four different light emitting surface (LES) configurations and has been engineered to reliably operate over a broad current range, enabling new degrees of flexibility in luminaire design optimization. Vero arrays deliver increased lumen density to enable improved beam control and precision lighting with 2 and 3 SDCM color control standard for clean and consistent uniform lighting.

Vero includes an on board connector port to enable solder free electrical interconnect and simple easy to use mounting features to enable plug-and-play installation.

Features

- Efficacy of 130 lm/W typical
- Vero 10 lumen output performance ranges from 480 to 2,453 lumens
- Broad range of CCT options from 2700K to 5000K
- CRI options include minimum 70, 80, and 90
- 2 and 3 SDCM color control for 2700K-4000K CCT
- Reliable operation at up to 2X nominal drive current
- Radial die pattern and improved lumen density
- Thermally isolated solder pads
- Onboard connector port
- Top side part number markings

Benefits

- Broad application coverage for interior and exterior lighting
- Flexibility for application driven lighting design requirements
- High quality true color reproduction
- Uniform consistent white light
- Flexibility in design optimization
- Improved optical control
- Enhanced ease of use and manufacturability
- Solderless connectivity enables plug & play installation and field upgradability
- Improved inventory management and quality control

Contents

Product Feature Map	2
Product Nomenclature	2
Product Selection Guide	3
Performance at Commonly Used Drive Currents	4
Electrical Characteristics	6
Absolute Maximum Ratings	7
Performance Curves	8
Typical Radiation Pattern	12
Typical Color Spectrum	13
Mechanical Dimensions	14
Color Binning Information	15
Packaging and Labeling	16
Design Resources	18
Precautions	18
Disclaimers	18
About Bridgelux	19

Product Selection Guide

The following product configurations are available:

Table 1: Selection Guide, Pulsed Measurement Data ($T_j = T_c = 25^\circ\text{C}$)

Part Number	Nominal CCT ¹ (K)	CRI ²	Nominal Drive Current ³ (mA)	Typical Pulsed Flux ^{4,5,6} $T_c = 25^\circ\text{C}$ (lm)	Minimum Pulsed Flux ^{6,7} $T_c = 25^\circ\text{C}$ (lm)	Typical V_f (V)	Typical Power (W)	Typical Efficacy (lm/W)
BXRC-27E1000-B-2x	2700	80	350	1161	1105	26.5	9.3	125
BXRC-27G1000-B-2x	2700	90	350	982	894	26.5	9.3	106
BXRC-30E1000-B-2x	3000	80	350	1207	1110	26.5	9.3	130
BXRC-30G1000-B-2x	3000	90	350	1021	922	26.5	9.3	110
BXRC-35E1000-B-2x	3500	80	350	1257	1109	26.5	9.3	136
BXRC-35G1000-B-2x	3500	90	350	1066	1044	26.5	9.3	115
BXRC-40E1000-B-2x	4000	80	350	1274	1182	26.5	9.3	137
BXRC-40G1000-B-2x	4000	90	350	1076	1017	26.5	9.3	116
BXRC-50C1000-B-24	5000	70	350	1373	1260	26.5	9.3	148
BXRC-50E1000-B-24	5000	80	350	1274	1193	26.5	9.3	137
BXRC-50G1000-B-24	5000	90	350	1130	1038	26.5	9.3	122

Table 2: Selection Guide, Stabilized DC Performance ($T_c = 85^\circ\text{C}$)^{8,9}

Part Number	Nominal CCT ¹ (K)	CRI ²	Nominal Drive Current ³ (mA)	Typical DC Flux $T_c = 85^\circ\text{C}$ (lm)	Minimum DC Flux ¹⁰ $T_c = 85^\circ\text{C}$ (lm)	Typical V_f (V)	Typical Power (W)	Typical Efficacy (lm/W)
BXRC-27E1000-B-2x	2700	80	350	1032	982	25.7	9.0	115
BXRC-27G1000-B-2x	2700	90	350	873	795	25.7	9.0	97
BXRC-30E1000-B-2x	3000	80	350	1073	987	25.7	9.0	120
BXRC-30G1000-B-2x	3000	90	350	908	820	25.7	9.0	101
BXRC-35E1000-B-2x	3500	80	350	1118	986	25.7	9.0	124
BXRC-35G1000-B-2x	3500	90	350	948	928	25.7	9.0	106
BXRC-40E1000-B-2x	4000	80	350	1128	1047	25.7	9.0	126
BXRC-40G1000-B-2x	4000	90	350	953	901	25.7	9.0	106
BXRC-50C1000-B-24	5000	70	350	1207	1108	25.7	9.0	134
BXRC-50E1000-B-24	5000	80	350	1120	1049	25.7	9.0	125
BXRC-50G1000-B-24	5000	90	350	993	913	25.7	9.0	111

Notes for Tables 1 & 2:

- Nominal CCT as defined by ANSI C78.377-2011.
- CRI Values are minimums. Minimum Rg value for 80 CRI products is 0, the minimum Rg values for 90 CRI products is 50.
- Drive current is referred to as nominal drive current.
- Products tested under pulsed condition (10ms pulse width) at nominal test current where T_j (junction temperature) = T_c (case temperature) = 25°C .
- Typical performance values are provided as a reference only and are not a guarantee of performance.
- Bridgelux maintains a $\pm 7\%$ tolerance on flux measurements.
- Minimum flux values at the nominal test current are guaranteed by 100% test.
- Typical stabilized DC performance values are provided as reference only and are not a guarantee of performance.
- Typical performance is estimated based on operation under DC (direct current) with LED array mounted onto a heat sink with thermal interface material and the case temperature maintained at 85°C . Based on Bridgelux test setup, values may vary depending on the thermal design of the luminaire and/or the exposed environment to which the product is subjected.
- Minimum flux values at elevated temperatures are provided for reference only and are not guaranteed by 100% production testing. Based on Bridgelux test setup, values may vary depending on the thermal design of the luminaire and/or the exposed environment to which the product is subjected.

Performance at Commonly Used Drive Currents

Vero LED arrays are tested to the specifications shown using the nominal drive currents in Table 1. Vero may also be driven at other drive currents dependent on specific application design requirements. The performance at any drive current can be derived from the current vs. voltage characteristics shown in Figure 2 and the flux vs. current characteristics shown in Figure 3. The performance at commonly used drive currents is summarized in Table 3.

Table 3: Product Performance at Commonly Used Drive Currents

Part Number	CRI	Drive Current ¹ (mA)	Typical V_f $T_c = 25^\circ\text{C}$ (V)	Typical Power $T_j = 25^\circ\text{C}$ (W)	Typical Flux ² $T_c = 25^\circ\text{C}$ (lm)	Typical DC Flux ³ $T_c = 85^\circ\text{C}$ (lm)	Typical Efficacy $T_j = 25^\circ\text{C}$ (lm/W)
BXRC-27E1000-B-2x	80	175	24.9	4.4	615	547	141
		350	26.5	9.3	1161	1032	125
		500	27.6	13.8	1586	1410	115
		700	29.0	20.3	2074	1844	102
BXRC-27G1000-B-2x	90	175	24.9	4.4	520	462	119
		350	26.5	9.3	982	873	106
		500	27.6	13.8	1342	1193	97
		700	29.0	20.3	1755	1560	86
BXRC-30E1000-B-2x	80	175	24.9	4.4	639	568	147
		350	26.5	9.3	1207	1073	130
		500	27.6	13.8	1649	1467	120
		700	29.0	20.3	2157	1918	106
BXRC-30G1000-B-2x	90	175	24.9	4.4	541	481	124
		350	26.5	9.3	1021	908	110
		500	27.6	13.8	1395	1241	101
		700	29.0	20.3	1824	1622	90
BXRC-35E1000-B-2x	80	175	24.9	4.4	666	592	153
		350	26.5	9.3	1257	1118	136
		500	27.6	13.8	1718	1528	124
		700	29.0	20.3	2246	1997	111
BXRC-35G1000-B-2x	90	175	24.9	4.4	565	502	130
		350	26.5	9.3	1066	948	115
		500	27.6	13.8	1457	1295	106
		700	29.0	20.3	1905	1694	94

Notes for Table 3:

1. Alternate drive currents in Table 3 are provided for reference only and are not a guarantee of performance.
2. Bridgelux maintains a $\pm 7\%$ tolerance on flux measurements.
3. Typical stabilized DC performance values are provided as reference only and are not a guarantee of performance.

Performance at Commonly Used Drive Currents

Table 3: Product Performance at Commonly Used Drive Currents (Continued)

Part Number	CRI	Drive Current ¹ (mA)	Typical V_f $T_c = 25^\circ\text{C}$ (V)	Typical Power $T_j = 25^\circ\text{C}$ (W)	Typical Flux ² $T_c = 25^\circ\text{C}$ (lm)	Typical DC Flux ³ $T_c = 85^\circ\text{C}$ (lm)	Typical Efficacy $T_j = 25^\circ\text{C}$ (lm/W)
BXRC-40E1000-B-2x	80	175	24.9	4.4	675	598	155
		350	26.5	9.3	1274	1128	137
		500	27.6	13.8	1741	1542	126
		700	29.0	20.3	2276	2016	112
BXRC-40G1000-B-2x	90	175	24.9	4.4	570	505	131
		350	26.5	9.3	1076	953	116
		500	27.6	13.8	1470	1302	107
		700	29.0	20.3	1923	1703	95
BXRC-50C1000-B-24	70	175	24.9	4.4	727	639	167
		350	26.5	9.3	1373	1207	148
		500	27.6	13.8	1876	1650	136
		700	29.0	20.3	2453	2157	121
BXRC-50E1000-B-24	80	175	24.9	4.4	675	593	155
		350	26.5	9.3	1274	1120	137
		500	27.6	13.8	1741	1531	126
		700	29.0	20.3	2276	2001	112
BXRC-50G1000-B-24	90	175	24.9	4.4	598	526	137
		350	26.5	9.3	1130	993	122
		500	27.6	13.8	1544	1358	112
		700	29.0	20.3	2019	1775	99

Notes for Table 3:

1. Alternate drive currents in Table 3 are provided for reference only and are not a guarantee of performance.
2. Bridgelux maintains a $\pm 7\%$ tolerance on flux measurements.
3. Typical stabilized DC performance values are provided as reference only and are not a guarantee of performance.

Electrical Characteristics

Table 4: Electrical Characteristics

Part Number	Drive Current (mA)	Forward Voltage Pulsed, $T_c = 25^\circ\text{C}$ (V) ^{1, 2, 3}			Typical Coefficient of Forward Voltage ⁴ $\Delta V_f / \Delta T_c$ (mV/ $^\circ\text{C}$)	Typical Thermal Resistance Junction to Case ^{5, 6} R_{j-c} ($^\circ\text{C}/\text{W}$)	Driver Selection Voltages ⁷ (V)	
		Minimum	Typical	Maximum			V_f Min. Hot $T_c = 105^\circ\text{C}$ (V)	V_f Max. Cold $T_c = -40^\circ\text{C}$ (V)
BXRC-xxx1000-B-2x	350	24.5	26.5	28.5	-14	0.47	23.4	29.4
	700	26.5	29.0	31.2	-14	0.59	25.4	32.1

Notes for Table 4:

1. Parts are tested in pulsed conditions, $T_c = 25^\circ\text{C}$. Pulse width is 10ms.
2. Voltage minimum and maximum are provided for reference only and are not a guarantee of performance.
3. Bridgelux maintains a tester tolerance of $\pm 0.10\text{V}$ on forward voltage measurements.
4. Typical coefficient of forward voltage tolerance is $\pm 0.1\text{mV}$ for nominal current.
5. Thermal resistance values are based from test data of a 3000K 80 CRI product.
6. Thermal resistance value was calculated using total electrical input power; optical power was not subtracted from input power. The thermal interface material used during testing is not included in the thermal resistance value.
7. V_f min hot and max cold values are provided as reference only and are not guaranteed by test. These values are provided to aid in driver design and selection over the operating range of the product.

Absolute Maximum Ratings

Table 5: Maximum Ratings

Parameter	Maximum Rating
LED Junction Temperature (T_j)	150°C
Storage Temperature	-40°C to +105°C
Operating Case Temperature ¹ (T_c)	105°C
Soldering Temperature ²	350°C or lower for a maximum of 10 seconds
Maximum Drive Current ³	700mA
Maximum Peak Pulsed Drive Current ⁴	1500mA
Maximum Reverse Voltage ⁵	-45V

Notes for Table 5:

1. Please refer to Figure 1 for drive current derating. For IEC 62717 requirement, please contact Bridgelux Sales Support.
2. See Bridgelux Application Note AN31, Assembly Considerations for Vero LED arrays, for more information.
3. Please refer to Figure 1 for drive current derating curve.
4. Bridgelux recommends a maximum duty cycle of 10% and pulse width of 20ms when operating LED Arrays at the maximum peak pulsed current specified. Maximum peak pulsed currents indicate values where the LED array can be driven without catastrophic failures.
5. Light emitting diodes are not designed to be driven in reverse voltage and will not produce light under this condition. Maximum rating provided for reference only.

Performance Curves

The maximum allowable drive current for the Vero 10 family of products is dependent on the operating case temperature. Please refer to the Product Feature Map (page 2) for the location of the T_c Point.

Figure 1: Vero 10 Drive Current Derating Curve

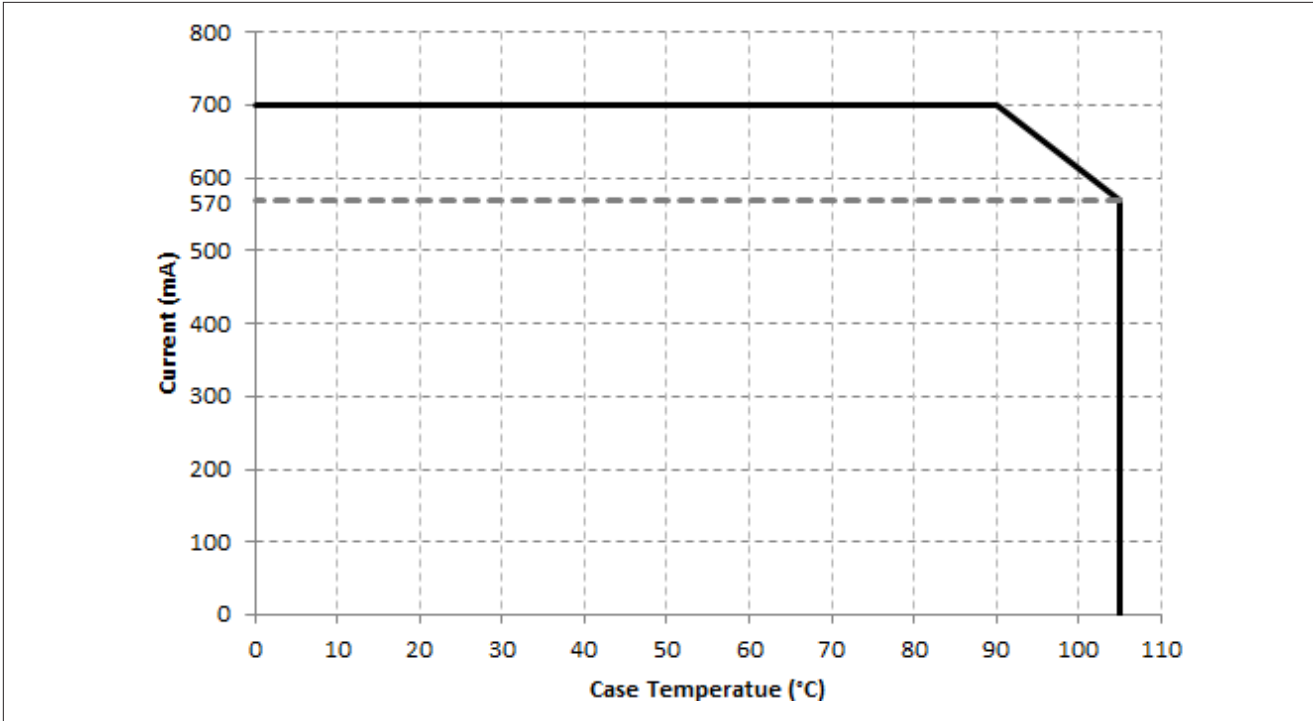

Notes for Figure 1:

1. In order to meet LM-80 lifetime projections Vero 10 may be driven up to 700mA at case temperatures up to 90°C. Operating conditions above case temperatures of 90°C driving conditions must follow the Vero 10 Drive Current Derating Curve.
2. Lumen maintenance (L70) and lifetime predictions are valid for drive current and case temperature conditions used for LM-80 testing as included in the applicable LM-80 test report for these products. Contact your Bridgelux sales representative for LM-80 report.

Performance Curves

Figure 2: Drive Current vs. Forward Voltage ($T_j = T_c = 25^\circ\text{C}$)

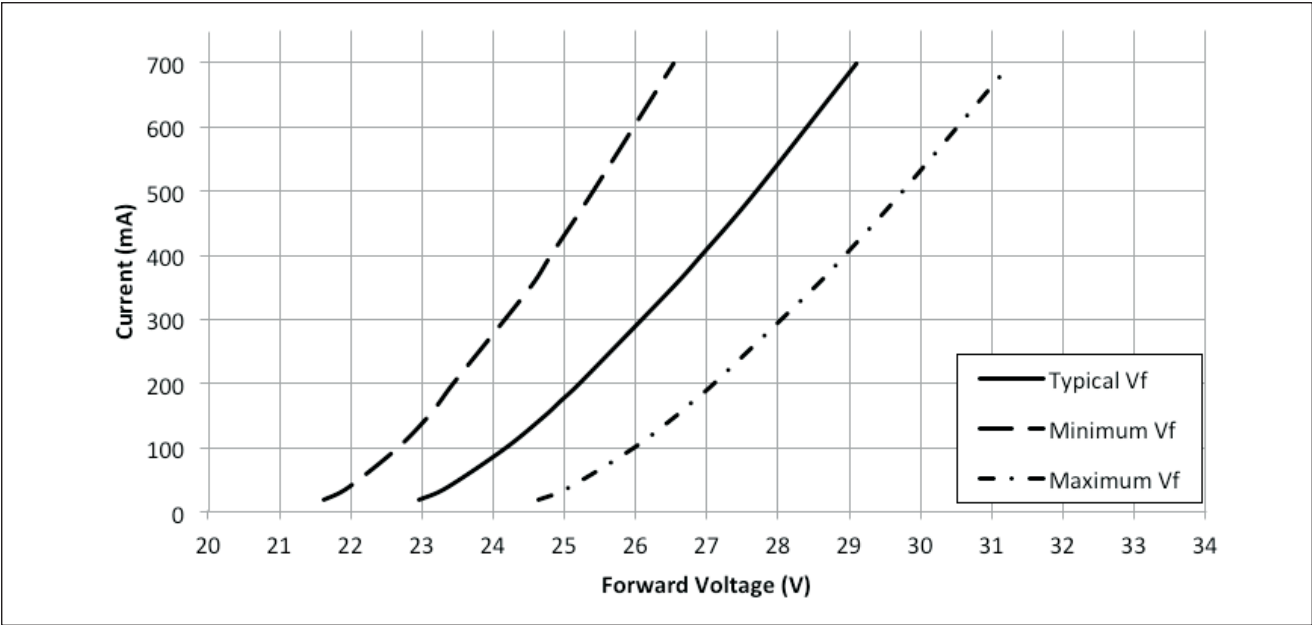
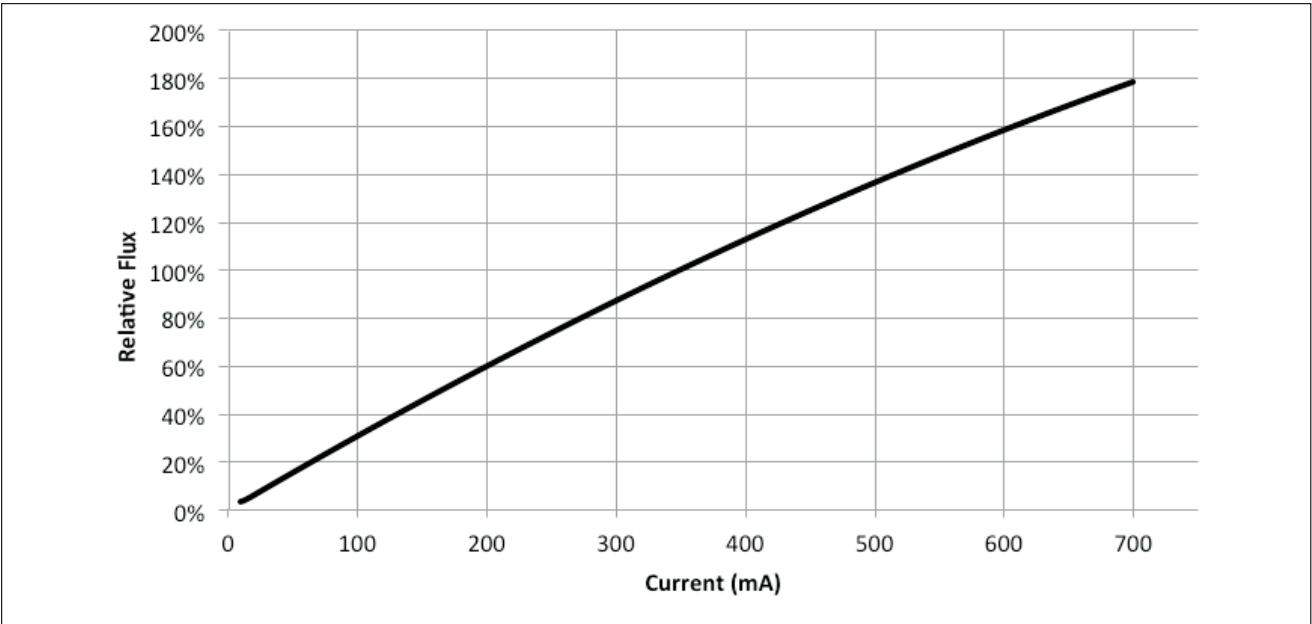

Figure 3: Typical Relative Luminous Flux vs. Drive Current ($T_j = T_c = 25^\circ\text{C}$)



Performance Curves

Figure 4: Typical DC Flux vs. Case Temperature

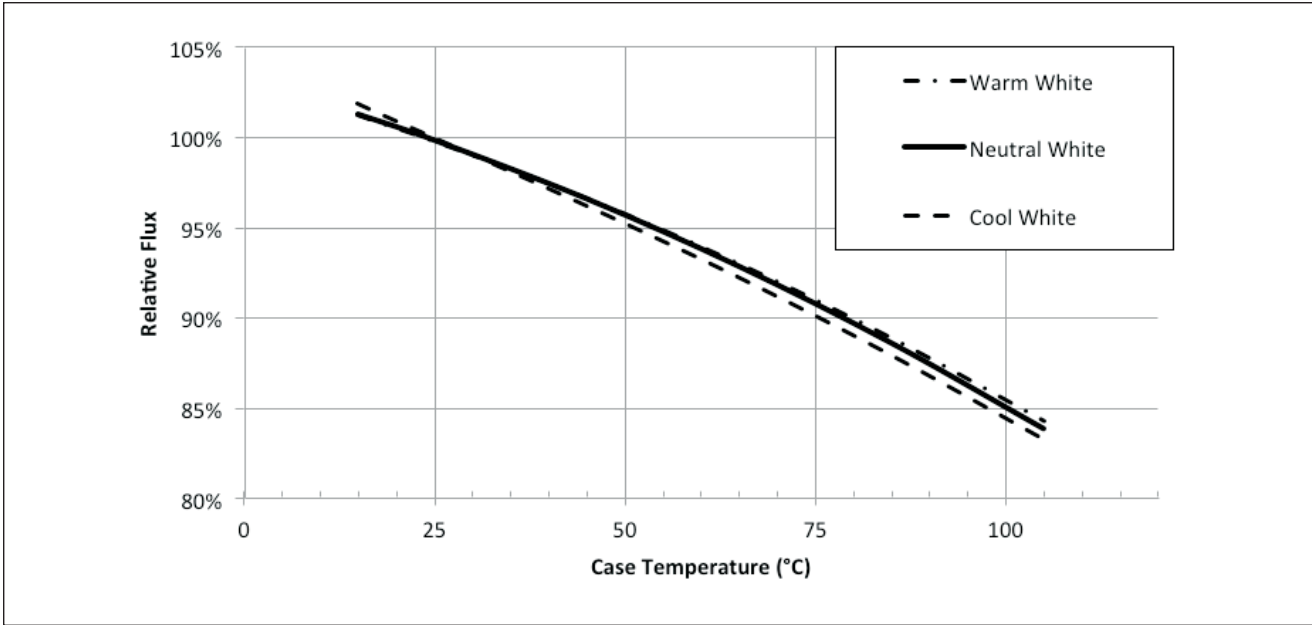
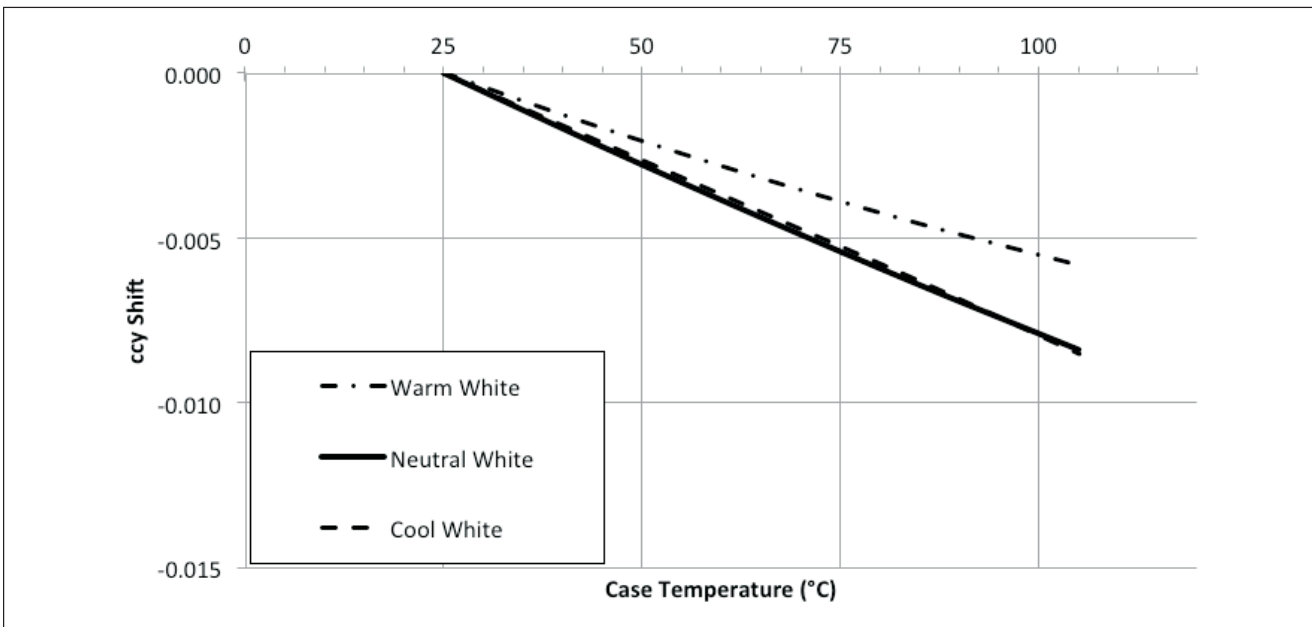

Figure 5: Typical DC ccy Shift vs. Case Temperature



Notes for Figures 4-5:

1. Characteristics shown for warm white based on 3000K and 80 CRI.
2. Characteristics shown for neutral white based on 4000K and 80 CRI.
3. Characteristics shown for cool white based on 5000K and 70 CRI.
4. For other color SKUs, the shift in color will vary. Please contact your Bridgelux Sales Representative for more information.

Performance Curves

Figure 6: Typical DC ccx Shift vs. Case Temperature

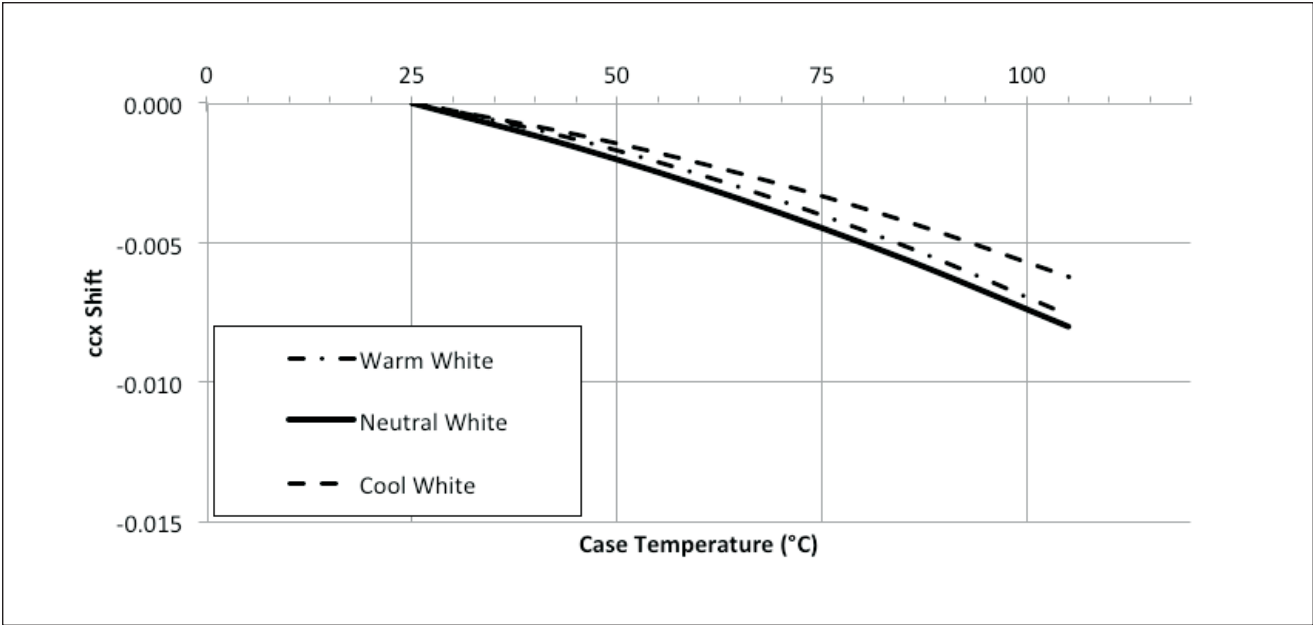

Notes for Figure 6:

- 1. Characteristics shown for warm white based on 3000K and 80 CRI.
- 2. Characteristics shown for neutral white based on 4000K and 80 CRI.
- 3. Characteristics shown for cool white based on 5000K and 70 CRI.
- 4. For other color SKUs, the shift in color will vary. Please contact your Bridgelux Sales Representative for more information.

Typical Radiation Pattern

Figure 7: Typical Spatial Radiation Pattern

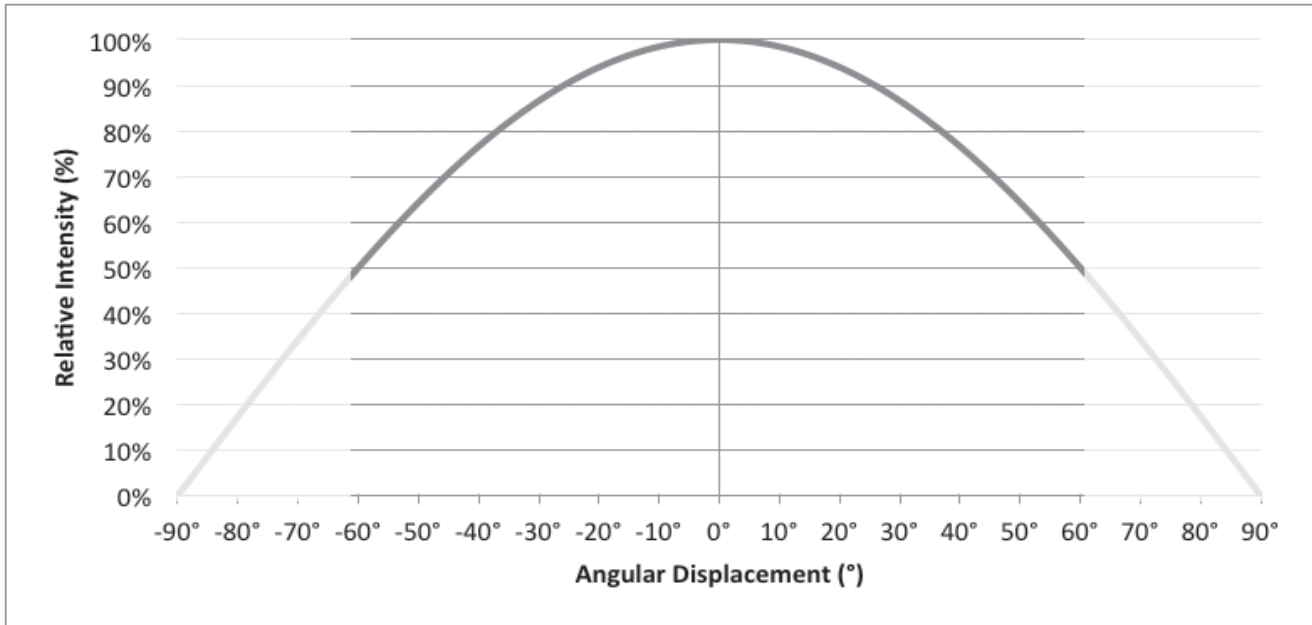

Notes for Figure 7:

1. Typical viewing angle is 120°.
2. The viewing angle is defined as the off axis angle from the centerline where intensity is ½ of the peak value.

Figure 8: Typical Polar Radiation Pattern

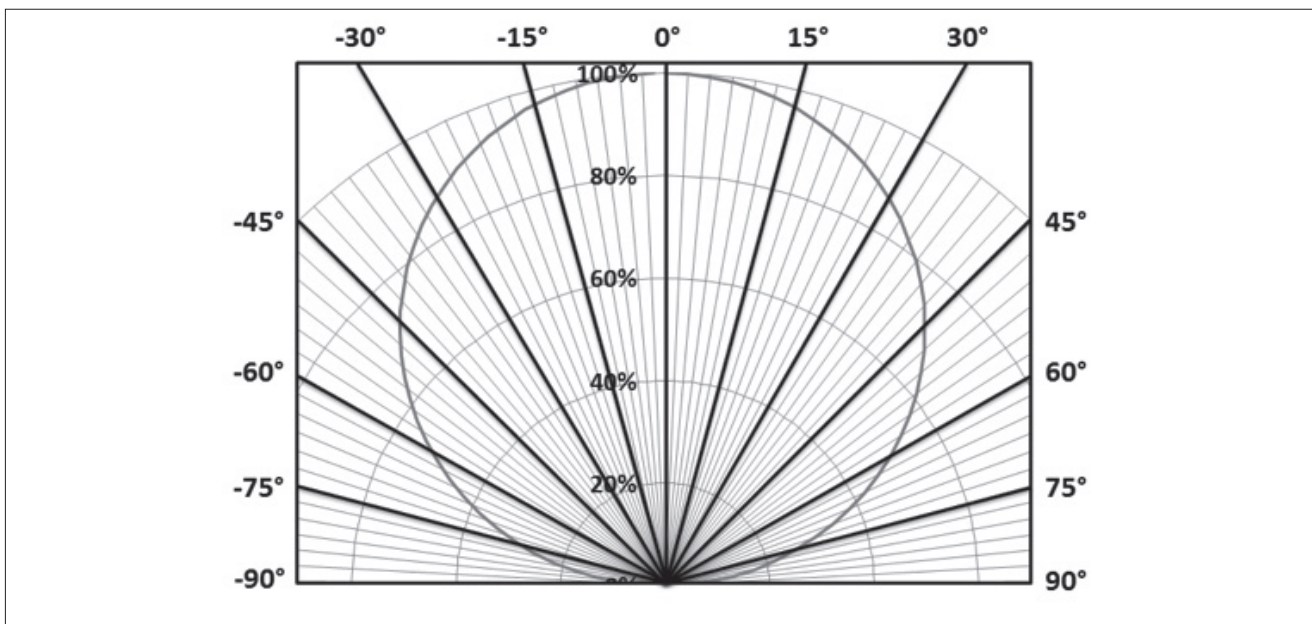

Typical Color Spectrum

Figure 9: Typical Color Spectrum

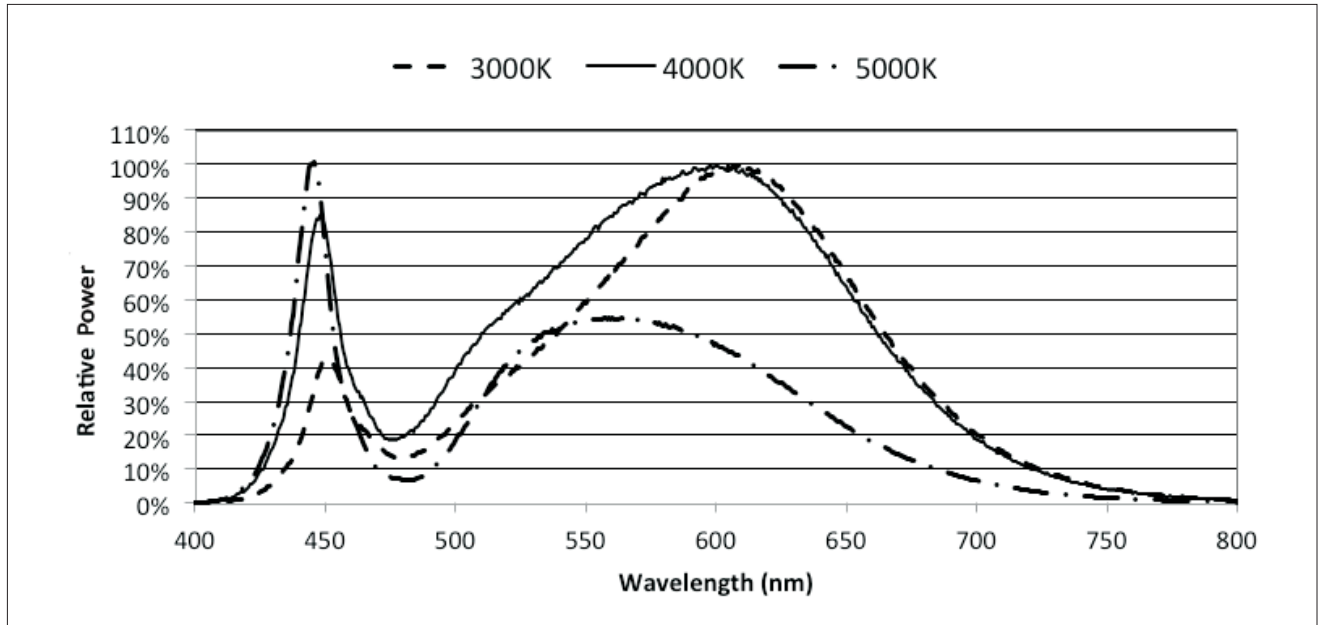

Notes for Figure 9:

1. Color spectra measured at rated current for $T_j = T_c = 25^\circ\text{C}$.
2. Color spectra shown is 3000K and 80 CRI.
3. Color spectra shown is 4000K and 80 CRI.
4. Color spectra shown is 5000K and 70 CRI.

Mechanical Dimensions

Figure 10: Drawing for Vero 10 LED Array

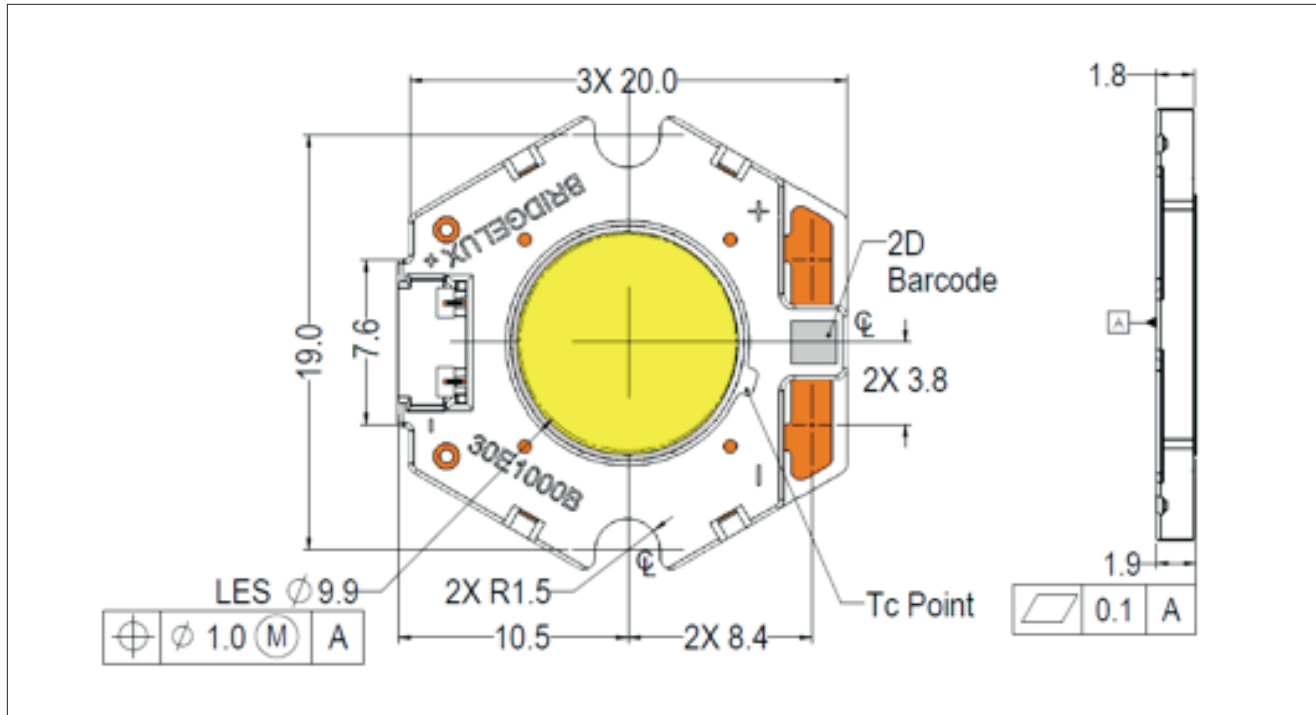

Notes for Figure 10:

1. Drawings are not to scale.
2. Dimensions are in mm.
3. Unless otherwise specified, tolerances are $\pm 0.10\text{mm}$.
4. Mounting slots (2X) are for M2.5 screws.
5. Bridgelux recommends two tapped holes for mounting screws with $19.0 \pm 0.10\text{mm}$ center-to-center spacing.
6. Screws with flat shoulders (pan, dome, button, round, truss, mushroom) provide optimal torque control. Do NOT use flat, countersink, or raised head screws.
7. Solder pads and connector port are labeled "+" and "-" to denote positive and negative, respectively.
8. It is not necessary to provide electrical connections to both the solder pads and the connector port. Either set may be used depending on application specific design requirements.
9. Refer to Application Notes AN30 and AN31 for product handling, mounting and heat sink recommendations.
10. The optical center of the LED Array is nominally defined by the mechanical center of the array to a tolerance of $\pm 0.2\text{mm}$.
11. Bridgelux maintains a flatness of 0.10mm across the mounting surface of the array.

Color Binning Information

Figure 11: Graph of Warm and Neutral White Test Bins in xy Color Space

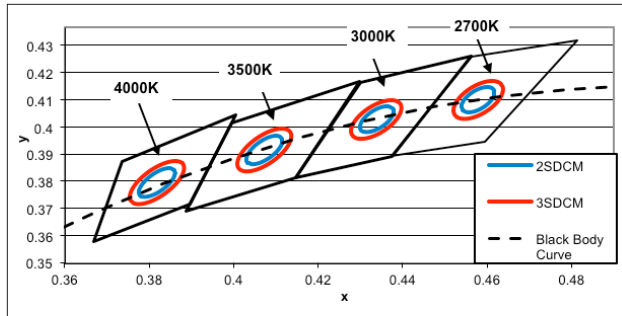

Note: Pulsed Test Conditions, $T_c = 25^\circ\text{C}$

Table 6: Warm and Neutral White xy Bin Coordinates and Associated Typical CCT

Bin Code	2700K	3000K	3500K	4000K
ANSI Bin (for reference only)	(2580K - 2870K)	(2870K - 3220K)	(3220K - 3710K)	(3710K - 4260K)
23 (3SDCM)	(2651K - 2794K)	(2968K - 3136K)	(3369K - 3586K)	(3851K - 4130K)
22 (2SDCM)	(2674K - 2769K)	(2995K - 3107K)	(3404K - 3548K)	(3895K - 4081K)
Center Point (x,y)	(0.4578, 0.4101)	(0.4338, 0.403)	(0.4073, 0.3917)	(0.3818, 0.3797)

Figure 12: Graph of Cool White Test Bins in xy Color Space

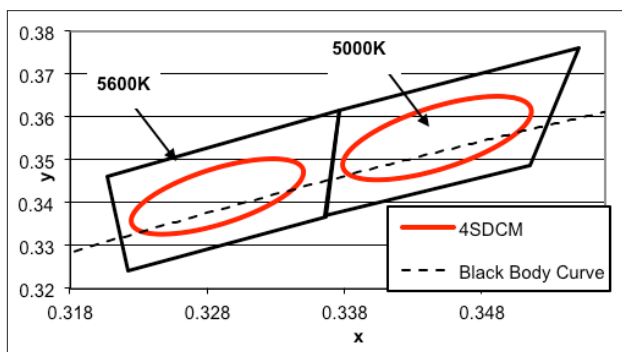

Note: Pulsed Test Conditions, $T_c = 25^\circ\text{C}$

Table 7: Cool White xy Bin Coordinates and Associated Typical CCT

Bin Code	5000K	5600K
ANSI Bin (for reference only)	(4745K - 5311K)	(5310K - 6020K)
24 (4SDCM)	(4801K - 5282K)	(5475K - 5830K)
Center Point (x,y)	(0.3447, 0.3553)	(0.3293, 0.3423)

Packaging and Labeling

Figure 13: Drawing for Vero 10 Packaging Tray

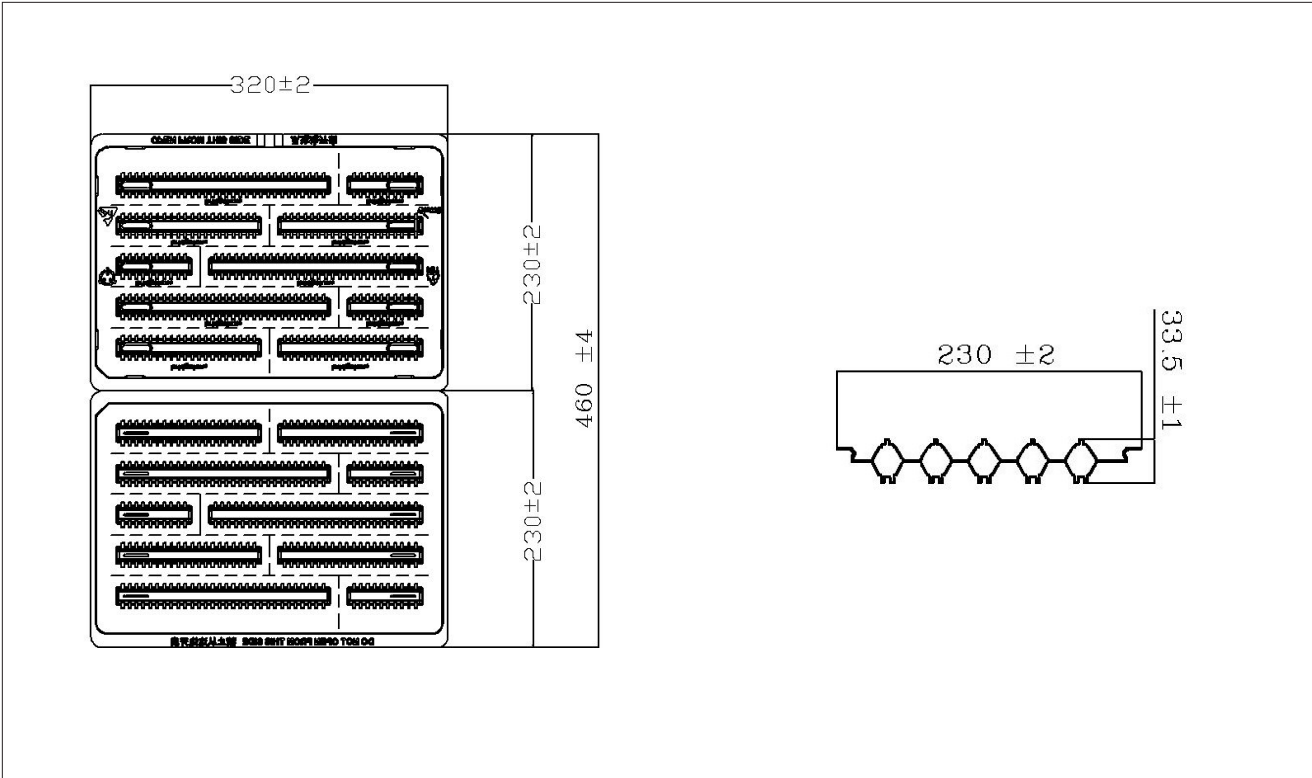

- Notes for Figure 13:
- 1. Dimensions are in millimeters.
 - 2. Drawing is not to scale.

Packaging and Labeling

Figure 14: Vero Series Packaging and Labeling



Notes for Figure 14:

1. Each tray holds 200 COBs.
2. Each tray is vacuum sealed in an anti-static bag and placed in its own box.
3. Each tray, bag and box is to be labeled as shown above.

Figure 15: Product Labeling

Bridgelux COB arrays have laser markings on the back side of the substrate to help with product identification. In addition to the product identification markings, Bridgelux COB arrays also contain markings for internal Bridgelux manufacturing use only. The image below shows which markings are for customer use and which ones are for Bridgelux internal use only. The Bridgelux internal manufacturing markings are subject to change without notice, however these will not impact the form, function or performance of the COB array.



Design Resources

Application Notes

Bridgelux has developed a comprehensive set of application notes and design resources to assist customers in successfully designing with the Vero product family of LED array products. For all available application notes visit www.bridgelux.com.

Optical Source Models

Optical source models and ray set files are available for all Bridgelux products. For a list of available formats, visit www.bridgelux.com.

3D CAD Models

Three dimensional CAD models depicting the product outline of all Bridgelux Vero LED arrays are available in both IGS and STEP formats. Please contact your Bridgelux sales representative for assistance.

Precautions

CAUTION: CHEMICAL EXPOSURE HAZARD

Exposure to some chemicals commonly used in luminaire manufacturing and assembly can cause damage to the LED array. Please consult Bridgelux Application Note AN31 for additional information.

CAUTION: EYE SAFETY

Eye safety classification for the use of Bridgelux Vero LED arrays is in accordance with IEC specification EN62471: Photobiological Safety of Lamps and Lamp Systems. Vero LED arrays are classified as Risk Group 1 (Low Risk) when operated at or below the maximum drive current. Please use appropriate precautions. It is important that employees working with LEDs are trained to use them safely.

CAUTION: RISK OF BURN

Do not touch the Vero LED array during operation. Allow the array to cool for a sufficient period of time before handling. The Vero LED array may reach elevated temperatures such that could burn skin when touched.

CAUTION

CONTACT WITH LIGHT EMITTING SURFACE (LES)

Avoid any contact with the LES. Do not touch the LES of the LED array or apply stress to the LES (yellow phosphor resin area). Contact may cause damage to the LED array.

Optics and reflectors must not be mounted in contact with the LES (yellow phosphor resin area). Optical devices may be mounted on the top surface of the plastic housing of the Vero LED array. Use the mechanical features of the LED array housing, edges and/or mounting holes to locate and secure optical devices as needed.

Disclaimers

MINOR PRODUCT CHANGE POLICY

The rigorous qualification testing on products offered by Bridgelux provides performance assurance. Slight cosmetic changes that do not affect form, fit, or function may occur as Bridgelux continues product optimization.

STANDARD TEST CONDITIONS

Unless otherwise stated, array testing is performed at the nominal drive current.

About Bridgelux: We Build Light That Transforms

At Bridgelux, we help companies, industries and people experience the power and possibility of light. Since 2002, we've designed LED solutions that are high performing, energy efficient, cost effective and easy to integrate. Our focus is on light's impact on human behavior, delivering products that create better environments, experiences and returns—both experiential and financial. And our patented technology drives new platforms for commercial and industrial luminaires.

For more information about the company, please visit
bridgelux.com
twitter.com/Bridgelux
facebook.com/Bridgelux
WeChat ID: BridgeluxInChina



101 Portola Avenue
Livermore, CA 94551
Tel (925) 583-8400
Fax (925) 583-8410
www.bridgelux.com

© 2016 Bridgelux, Inc. All rights reserved 2016. Product specifications are subject to change without notice. Bridgelux, the Bridgelux stylized logo design and Vero are registered trademarks, and Decor Series is a trademark of Bridgelux, Inc. All other trademarks are the property of their respective owners.

Bridgelux Vero 10 Array Series Product Data Sheet DS30 Rev. L (06/2016)

X-ON Electronics

Largest Supplier of Electrical and Electronic Components

Click to view similar products for [bridgelux](#) manufacturer:

Other Similar products are found below :

[BXRC-30E1000-C-73](#) [BXRC-30G1000-C-73](#) [BXRC-35G4000-B-73](#) [BXRE-30G2000-C-73](#) [BXRE-40E2000-C-73](#) [BXKE-40G1501-B-23](#)
[BXEM-50C0000-0-000](#) [BXRC-17E10K0-C-74-SE](#) [BXRC-30G10K0-C-72-SE](#) [BXRC-40E2000-B-73](#) [BXRC-56G10K0-D-74](#) [BXRE-](#)
[27E1000-B-73](#) [BXRE-30G4000-B-73](#) [BXRE-40E2000-B-73](#) [BXRE-40E4000-B-73](#) [BXRE-50C2001-B-74](#) [BXRE-50S1001-C-74](#) [BXEN-](#)
[27S-11L-3C-00-0-0](#) [BXEN-27S-11M-3C-00-0-0](#) [BXEN-27S-13H-9C-00-0-0](#) [BXEN-30S-11L-3C-00-0-0](#) [BXEN-30S-11M-3C-00-0-0](#) [BXEN-](#)
[30S-13H-9C-00-0-0](#) [BXEN-35S-11L-3C-00-0-0](#) [BXEN-35S-11M-3C-00-0-0](#) [BXEN-35S-13H-9C-00-0-0](#) [BXEN-40S-11L-3C-00-0-0](#) [BXEN-](#)
[40S-13H-9C-00-0-0](#) [BXEN-50S-11L-3C-00-0-0](#) [BXEN-50S-13H-9C-00-0-0](#) [BXEN-57S-11L-3C-00-0-0](#) [BXEN-57S-13H-9C-00-0-0](#) [BXRE-](#)
[30S1001-B-73](#) [BXRE-57S1001-C-74](#) [BXRE-65S1001-C-74](#) [BXDR-30BT-U214P-01-A](#) [BXDR-60BT-U220P-01-A](#) [BXDR-60LT-U220P-01-](#)
[A](#) [BXRC-30E10K0-D-73-SE](#) [BXKE-27G1501-B-23](#) [BXRV-TR-2765G-30A0-A-23](#) [BXRC-35E4000-F-23](#) [BXRC-30E1000-B-23](#) [BXRC-](#)
[30E1000-D-73-SE](#) [BXRC-27G2000-C-23](#) [BXRC-27H1000-C-73](#) [BXRH-30E0600-A-73](#) [BXKE-27G0801-A-23](#) [BXKE-30G0801-A-23](#)
[BXKE-40G0801-A-23](#)