

# Bridgelux® Vero® 29 Array Series

Product Data Sheet DS33



BXRC-27x10K0

30x10K0

35x10K0

40x10K0

50x10K0

# Introduction

Vero



Vero represents a revolutionary advancement in chip on board (COB) light source technology and innovation. Vero LED light sources simplify luminaire design and manufacturing processes, improve light quality, and define a platform for future functionality integration.

Vero is available in four different light emitting surface (LES) configurations and has been engineered to reliably operate over a broad current range, enabling new degrees of flexibility in luminaire design optimization. Vero arrays deliver increased lumen density to enable improved beam control and precision lighting with 2 and 3 SDCM color control standard for clean and consistent uniform lighting.

Vero includes an on board connector port to enable solder free electrical interconnect and simple easy to use mounting features to enable plug-and-play installation.

## Features

- Efficacy of 130 lm/W typical
- Vero 29 lumen output performance ranges from 2,200 to 20,500 lumens
- Broad range of CCT options from 2700K to 5000K
- CRI options include minimum 70, 80, and 90
- 2 and 3 SDCM color control for 2700K-4000K CCT
- Reliable operation at up to 2X nominal drive current
- Radial die pattern and improved lumen density
- Thermally isolated solder pads
- Onboard connector port
- Top side part number markings

## Benefits

- Broad application coverage for interior and exterior lighting
- Flexibility for application driven lighting design requirements
- High quality true color reproduction
- Uniform consistent white light
- Flexibility in design optimization
- Improved optical control
- Enhanced ease of use and manufacturability
- Solderless connectivity enables plug & play installation and field upgradability
- Improved inventory management and quality control

# Contents

Product Feature Map	2
Product Nomenclature	2
Product Selection Guide	3
Performance at Commonly Used Drive Currents	4
Electrical Characteristics	6
Absolute Maximum Ratings	7
Performance Curves	8
Typical Radiation Pattern	12
Typical Color Spectrum	13
Mechanical Dimensions	14
Color Binning Information	15
Packaging and Labeling	16
Design Resources	18
Precautions	18
Disclaimers	18
About Bridgelux	19

---

# Product Feature Map

Vero 29 is the largest form factor in the Vero family of next generation solid state light sources. In addition to delivering the performance and light quality required for many lighting applications, Vero incorporates several

features to simplify the design integration and manufacturing process, accelerate time to market and reduce system costs. Please consult the Bridgelux Vero Array Series Product Brief for more information on the Vero family of products.

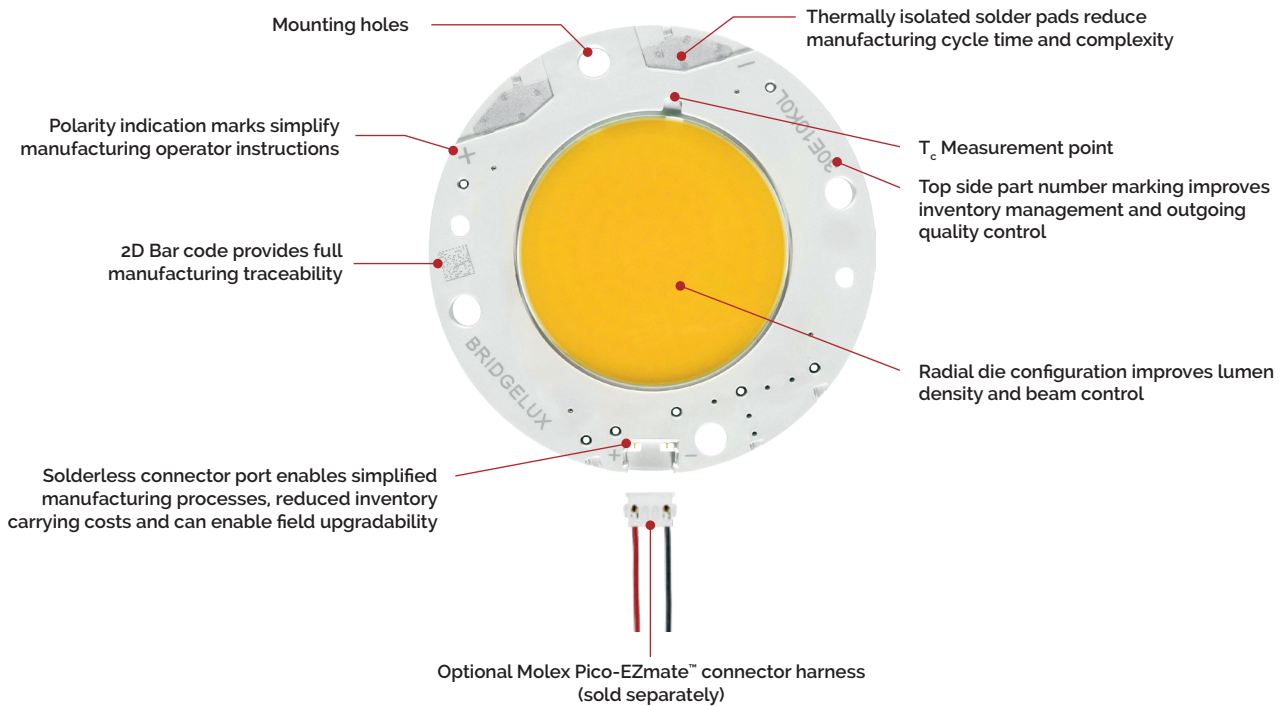

## Product Nomenclature

The part number designation for Bridgelux Vero LED arrays is explained as follows:

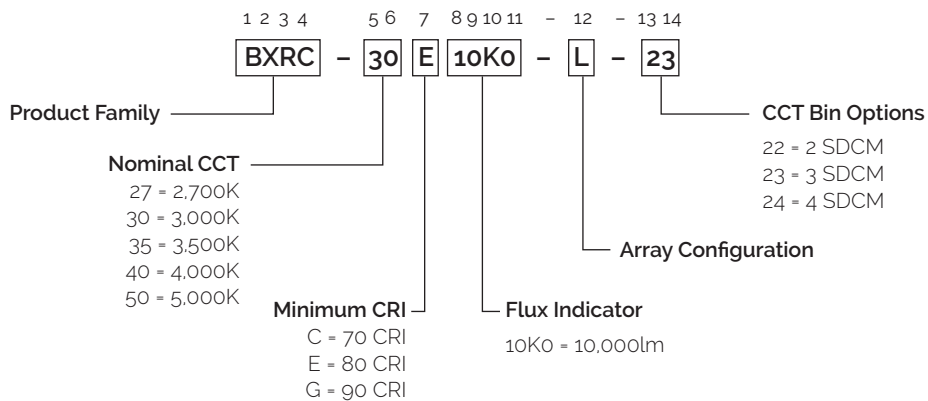

# Product Selection Guide

The following product configurations are available:

**Table 1:** Selection Guide, Pulsed Measurement Data ( $T_j = T_c = 25^\circ\text{C}$ )

Part Number	Nominal CCT <sup>1</sup> (K)	CRI <sup>2</sup>	Nominal Drive Current <sup>3</sup> (mA)	Typical Pulsed Flux <sup>4,5,6</sup> $T_c = 25^\circ\text{C}$ (lm)	Minimum Pulsed Flux <sup>6,7</sup> $T_c = 25^\circ\text{C}$ (lm)	Typical $V_f$ (V)	Typical Power (W)	Typical Efficacy (lm/W)
BXRC-27E10K0-L-2x	2700	80	2100	10113	9864	38.0	79.8	127
BXRC-27G10K0-L-2x	2700	90	2100	8666	8277	38.0	79.8	109
BXRC-30E10K0-L-2x	3000	80	2100	10943	10388	38.0	79.8	137
BXRC-30G10K0-L-2x	3000	90	2100	9060	8351	38.0	79.8	114
BXRC-35E10K0-L-2x	3500	80	2100	11399	10299	38.0	79.8	143
BXRC-35G10K0-L-2x	3500	90	2100	9705	8979	38.0	79.8	122
BXRC-40E10K0-L-2x	4000	80	2100	11597	10769	38.0	79.8	145
BXRC-40G10K0-L-2x	4000	90	2100	9720	9385	38.0	79.8	122
BXRC-50C10K0-L-24	5000	70	2100	12034	11177	38.0	79.8	151
BXRC-50E10K0-L-24	5000	80	2100	11397	10636	38.0	79.8	143
BXRC-50G10K0-L-24	5000	90	2100	10173	9951	38.0	79.8	127

**Table 2:** Selection Guide, Stabilized DC Performance ( $T_c = 85^\circ\text{C}$ )<sup>8,9</sup>

Part Number	Nominal CCT <sup>1</sup> (K)	CRI <sup>2</sup>	Nominal Drive Current <sup>3</sup> (mA)	Typical DC Flux $T_c = 85^\circ\text{C}$ (lm)	Minimum DC Flux <sup>10</sup> $T_c = 85^\circ\text{C}$ (lm)	Typical $V_f$ (V)	Typical Power (W)	Typical Efficacy (lm/W)
BXRC-27E10K0-L-2x	2700	80	2100	9156	8931	36.8	77.3	118
BXRC-27G10K0-L-2x	2700	90	2100	7626	7284	36.8	77.3	99
BXRC-30E10K0-L-2x	3000	80	2100	9933	9430	36.8	77.3	129
BXRC-30G10K0-L-2x	3000	90	2100	7973	7349	36.8	77.3	103
BXRC-35E10K0-L-2x	3500	80	2100	10231	9243	36.8	77.3	132
BXRC-35G10K0-L-2x	3500	90	2100	8540	7902	36.8	77.3	111
BXRC-40E10K0-L-2x	4000	80	2100	10416	9672	36.8	77.3	135
BXRC-40G10K0-L-2x	4000	90	2100	8554	8259	36.8	77.3	111
BXRC-50C10K0-L-24	5000	70	2100	10590	9836	36.8	77.3	137
BXRC-50E10K0-L-24	5000	80	2100	10029	9360	36.8	77.3	130
BXRC-50G10K0-L-24	5000	90	2100	8952	8757	36.8	77.3	116

Notes for Tables 1 & 2:

- Nominal CCT as defined by ANSI C78.377-2011.
- CRI Values are minimums. Minimum Rg value for 80 CRI products is 0, the minimum Rg values for 90 CRI products is 50.
- Drive current is referred to as nominal drive current.
- Products tested under pulsed condition (10ms pulse width) at nominal test current where  $T_j$  (junction temperature) =  $T_c$  (case temperature) =  $25^\circ\text{C}$ .
- Typical performance values are provided as a reference only and are not a guarantee of performance.
- Bridgelux maintains a  $\pm 7\%$  tolerance on flux measurements.
- Minimum flux values at the nominal test current are guaranteed by 100% test.
- Typical stabilized DC performance values are provided as reference only and are not a guarantee of performance.
- Typical performance is estimated based on operation under DC (direct current) with LED array mounted onto a heat sink with thermal interface material and the case temperature maintained at  $85^\circ\text{C}$ . Based on Bridgelux test setup, values may vary depending on the thermal design of the luminaire and/or the exposed environment to which the product is subjected.
- Minimum flux values at elevated temperatures are provided for reference only and are not guaranteed by 100% production testing. Based on Bridgelux test setup, values may vary depending on the thermal design of the luminaire and/or the exposed environment to which the product is subjected.

# Performance at Commonly Used Drive Currents

Vero LED arrays are tested to the specifications shown using the nominal drive currents in Table 1. Vero may also be driven at other drive currents dependent on specific application design requirements. The performance at any drive current can be derived from the current vs. voltage characteristics shown in Figure 2 and the flux vs. current characteristics shown in Figure 3. The performance at commonly used drive currents is summarized in Table 3.

**Table 3:** Product Performance at Commonly Used Drive Currents

Part Number	CRI	Drive Current <sup>1</sup> (mA)	Typical V <sub>f</sub> T <sub>c</sub> = 25°C (V)	Typical Watt T <sub>j</sub> = 25°C (W)	Typical Flux <sup>2</sup> T <sub>c</sub> = 25°C (lm)	Typical DC Flux <sup>3</sup> T <sub>c</sub> = 85°C (lm)	Typical Efficacy T <sub>j</sub> = 25°C (lm/W)
BXRC-27E10K0-L-2x	80	500	35.1	17.6	2753	2461	157
		700	35.6	24.9	3791	3384	152
		1050	36.4	38.2	5536	4941	145
		<b>2100</b>	<b>38.0</b>	<b>79.8</b>	<b>10113</b>	<b>9156</b>	<b>127</b>
		2800	39.0	109.2	12923	11584	118
		3150	39.5	124.4	14133	12685	114
4200	40.4	169.7	17227	15533	102		
BXRC-27G10K0-L-2x	90	500	35.1	17.6	2359	2049	134
		700	35.6	24.9	3248	2819	130
		1050	36.4	38.2	4744	4115	124
		<b>2100</b>	<b>38.0</b>	<b>79.8</b>	<b>8666</b>	<b>7626</b>	<b>109</b>
		2800	39.0	109.2	11074	9648	101
		3150	39.5	124.4	12111	10565	97
4200	40.4	169.7	14762	12937	87		
BXRC-30E10K0-L-2x	80	500	35.1	17.6	2979	2669	170
		700	35.6	24.9	4102	3671	165
		1050	36.4	38.2	5990	5360	157
		<b>2100</b>	<b>38.0</b>	<b>79.8</b>	<b>10943</b>	<b>9933</b>	<b>137</b>
		2800	39.0	109.2	13984	12568	128
		3150	39.5	124.4	15293	13762	123
4200	40.4	169.7	18641	16851	110		
BXRC-30G10K0-L-2x	90	500	35.1	17.6	2467	2143	141
		700	35.6	24.9	3396	2947	136
		1050	36.4	38.2	4959	4302	130
		<b>2100</b>	<b>38.0</b>	<b>79.8</b>	<b>9060</b>	<b>7973</b>	<b>114</b>
		2800	39.0	109.2	11578	10087	106
		3150	39.5	124.4	12662	11046	102
4200	40.4	169.7	15434	13525	91		
BXRC-35E10K0-L-2x	80	500	35.1	17.6	3103	2749	177
		700	35.6	24.9	4273	3781	171
		1050	36.4	38.2	6240	5520	163
		<b>2100</b>	<b>38.0</b>	<b>79.8</b>	<b>11399</b>	<b>10231</b>	<b>143</b>
		2800	39.0	109.2	14567	12944	133
		3150	39.5	124.4	15930	14174	128
4200	40.4	169.7	19418	17355	114		
BXRC-35G10K0-L-2x	90	500	35.1	17.6	2642	2295	151
		700	35.6	24.9	3638	3156	146
		1050	36.4	38.2	5312	4608	139
		<b>2100</b>	<b>38.0</b>	<b>79.8</b>	<b>9705</b>	<b>8540</b>	<b>122</b>
		2800	39.0	109.2	12402	10805	114
		3150	39.5	124.4	13563	11832	109
4200	40.4	169.7	16532	14488	97		

Notes for Table 3 can be found on page 5.

# Performance at Commonly Used Drive Currents

**Table 3:** Product Performance at Commonly Used Drive Currents (Continued)

Part Number	CRI	Drive Current <sup>1</sup> (mA)	Typical V <sub>f</sub> T <sub>c</sub> = 25°C (V)	Typical Watt T <sub>j</sub> = 25°C (W)	Typical Flux <sup>2</sup> T <sub>c</sub> = 25°C (lm)	Typical DC Flux <sup>3</sup> T <sub>c</sub> = 85°C (lm)	Typical Efficacy T <sub>j</sub> = 25°C (lm/W)
BXRC-40E10K0-L-2x	80	500	35.1	17.6	3157	2799	180
		700	35.6	24.9	4347	3850	174
		1050	36.4	38.2	6348	5621	166
		<b>2100</b>	<b>38.0</b>	<b>79.8</b>	<b>11597</b>	<b>10416</b>	<b>145</b>
		2800	39.0	109.2	14820	13178	136
		3150	39.5	124.4	16207	14431	130
		4200	40.4	169.7	19755	17670	116
BXRC-40G10K0-L-2x	90	500	35.1	17.6	2646	2299	151
		700	35.6	24.9	3643	3161	146
		1050	36.4	38.2	5321	4615	139
		<b>2100</b>	<b>38.0</b>	<b>79.8</b>	<b>9720</b>	<b>8554</b>	<b>122</b>
		2800	39.0	109.2	12421	10822	114
		3150	39.5	124.4	13584	11850	109
		4200	40.4	169.7	16558	14510	98
BXRC-50C10K0-L-24	70	500	35.1	17.6	3276	2846	187
		700	35.6	24.9	4511	3914	181
		1050	36.4	38.2	6587	5714	172
		<b>2100</b>	<b>38.0</b>	<b>79.8</b>	<b>12034</b>	<b>10590</b>	<b>151</b>
		2800	39.0	109.2	15378	13398	141
		3150	39.5	124.4	16818	14672	135
		4200	40.4	169.7	20500	17965	121
BXRC-50E10K0-L-24	80	500	35.1	17.6	3103	2695	177
		700	35.6	24.9	4272	3707	171
		1050	36.4	38.2	6239	5412	163
		<b>2100</b>	<b>38.0</b>	<b>79.8</b>	<b>11397</b>	<b>10029</b>	<b>143</b>
		2800	39.0	109.2	14564	12689	133
		3150	39.5	124.4	15928	13895	128
		4200	40.4	169.7	19415	17014	114
BXRC-50G10K0-L-24	90	500	35.1	17.6	2770	2406	158
		700	35.6	24.9	3813	3309	153
		1050	36.4	38.2	5569	4831	146
		<b>2100</b>	<b>38.0</b>	<b>79.8</b>	<b>10173</b>	<b>8952</b>	<b>127</b>
		2800	39.0	109.2	13000	11326	119
		3150	39.5	124.4	14217	12403	114
		4200	40.4	169.7	17330	15186	102

Notes for Table 3:

1. Alternate drive currents in Table 3 are provided for reference only and are not a guarantee of performance.
2. Bridgelux maintains a ± 7% tolerance on flux measurements.
3. Typical stabilized DC performance values are provided as reference only and are not a guarantee of performance.

# Electrical Characteristics

**Table 4:** Electrical Characteristics

Part Number	Drive Current (mA)	Forward Voltage Pulsed, $T_c = 25^\circ\text{C}$ (V) <sup>1, 2, 3</sup>			Typical Coefficient of Forward Voltage <sup>4</sup> $\Delta V_f / \Delta T_c$ (mV/ $^\circ\text{C}$ )	Typical Thermal Resistance Junction to Case <sup>5, 6</sup> $R_{j-c}$ ( $^\circ\text{C}/\text{W}$ )	Driver Selection Voltages <sup>7</sup> (V)	
		Minimum	Typical	Maximum			$V_f$ Min. Hot $T_c = 105^\circ\text{C}$ (V)	$V_f$ Max. Cold $T_c = -40^\circ\text{C}$ (V)
BXRC-xxx10K0-L-2x	2100	35.2	38.0	40.9	-20	0.06	33.6	42.2
	4200	37.3	40.4	44.0	-20	0.07	35.7	45.3

Notes for Table 4:

1. Parts are tested in pulsed conditions,  $T_c = 25^\circ\text{C}$ . Pulse width is 10ms.
2. Voltage minimum and maximum are provided for reference only and are not a guarantee of performance.
3. Bridgelux maintains a tester tolerance of  $\pm 0.10\text{V}$  on forward voltage measurements.
4. Typical coefficient of forward voltage tolerance is  $\pm 0.1\text{mV}$  for nominal current.
5. Thermal resistance values are based from test data of a 3000K 80 CRI product.
6. Thermal resistance value was calculated using total electrical input power; optical power was not subtracted from input power. The thermal interface material used during testing is not included in the thermal resistance value.
7.  $V_f$  min hot and max cold values are provided as reference only and are not guaranteed by test. These values are provided to aid in driver design and selection over the operating range of the product.



# Absolute Maximum Ratings

**Table 5:** Maximum Ratings

Parameter	Maximum Rating
LED Junction Temperature ( $T_j$ )	150°C
Storage Temperature	-40°C to +105°C
Operating Case Temperature <sup>1</sup> ( $T_c$ )	105°C
Soldering Temperature <sup>2</sup>	350°C or lower for a maximum of 10 seconds
Maximum Drive Current <sup>3</sup>	4200mA
Maximum Peak Pulsed Drive Current <sup>4</sup>	6000mA
Maximum Reverse Voltage <sup>5</sup>	-65V

Notes for Table 5:

1. Please refer to Figure 1 for drive current derating. For IEC 62717 requirement, please contact Bridgelux Sales Support.
2. See Bridgelux Application Note AN31, Assembly Considerations for Vero LED arrays, for more information.
3. Please refer to Figure 1 for drive current derating curve.
4. Bridgelux recommends a maximum duty cycle of 10% and pulse width of 20ms when operating LED Arrays at the maximum peak pulsed current specified. Maximum peak pulsed currents indicate values where the LED array can be driven without catastrophic failures.
5. Light emitting diodes are not designed to be driven in reverse voltage and will not produce light under this condition. Maximum rating provided for reference only.

# Performance Curves

The maximum allowable drive current for the Vero 29 family of products is dependent on the operating case temperature. Please refer to the Product Feature Map (page 2) for the location of the  $T_c$  Point.

**Figure 1: Vero 29 Drive Current Derating Curve**

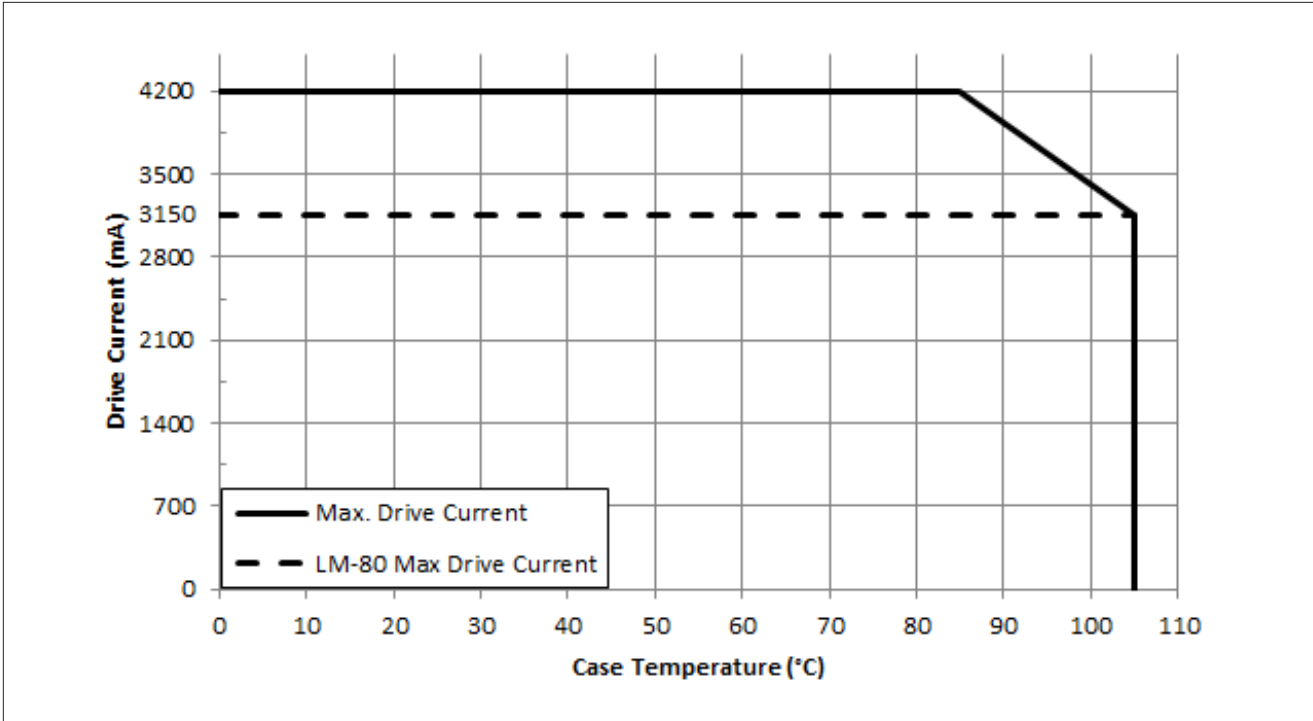

Notes for Figure 1:

1. LM-80 Max Drive Current must not be exceeded in order to meet LM-80 lifetime projections.
2. Lumen maintenance (L70) and lifetime predictions are valid for drive current and case temperature conditions used for LM-80 testing as included in the applicable LM-80 test report for these products. Contact your Bridgelux sales representative for LM-80 report.

# Performance Curves

Figure 2: Drive Current vs. Forward Voltage ( $T_j = T_c = 25^\circ\text{C}$ )

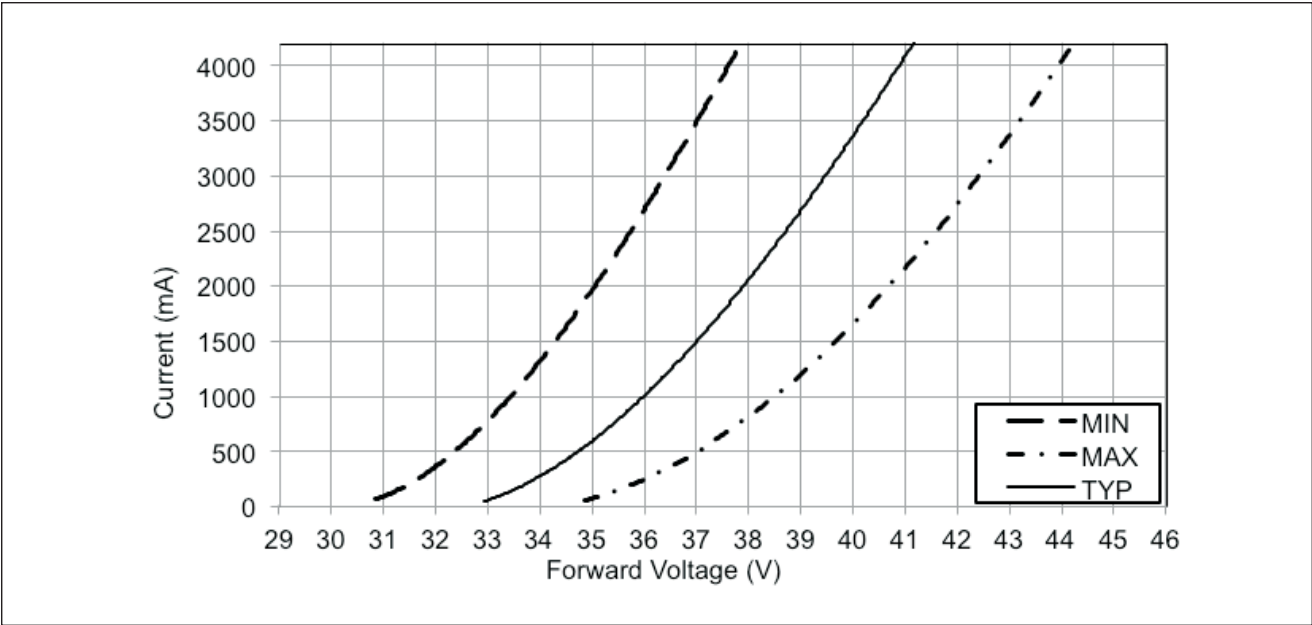
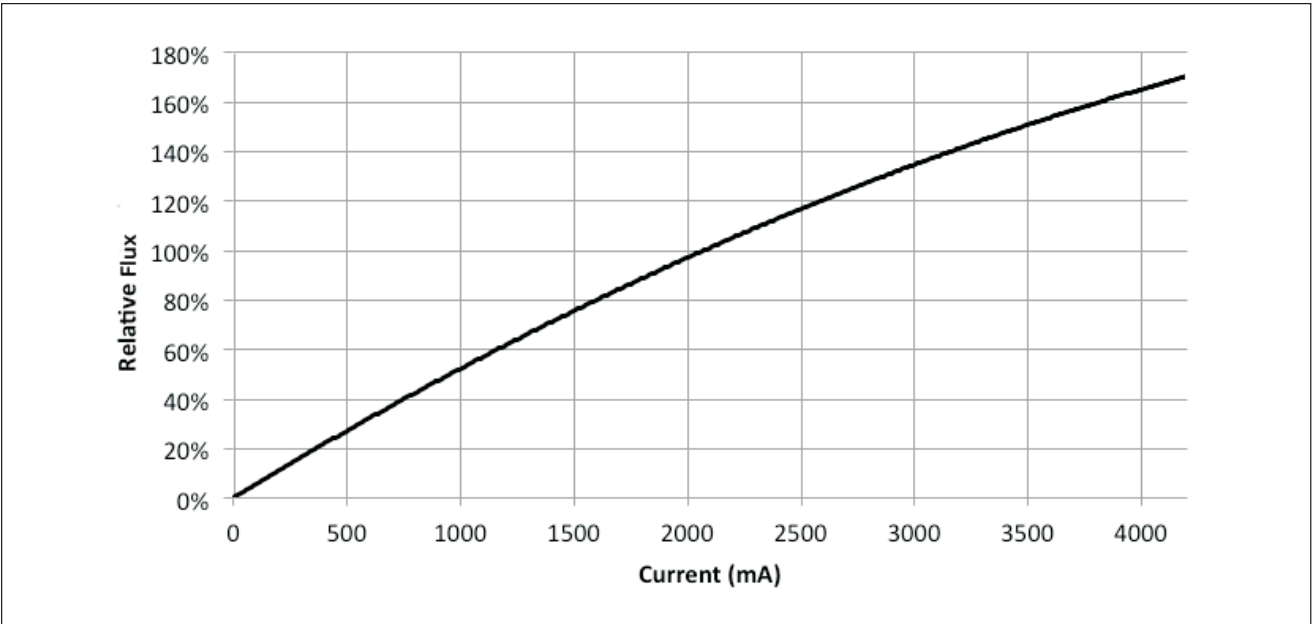

Figure 3: Typical Relative Luminous Flux vs. Drive Current ( $T_j = T_c = 25^\circ\text{C}$ )



# Performance Curves

Figure 4: Typical DC Flux vs. Case Temperature

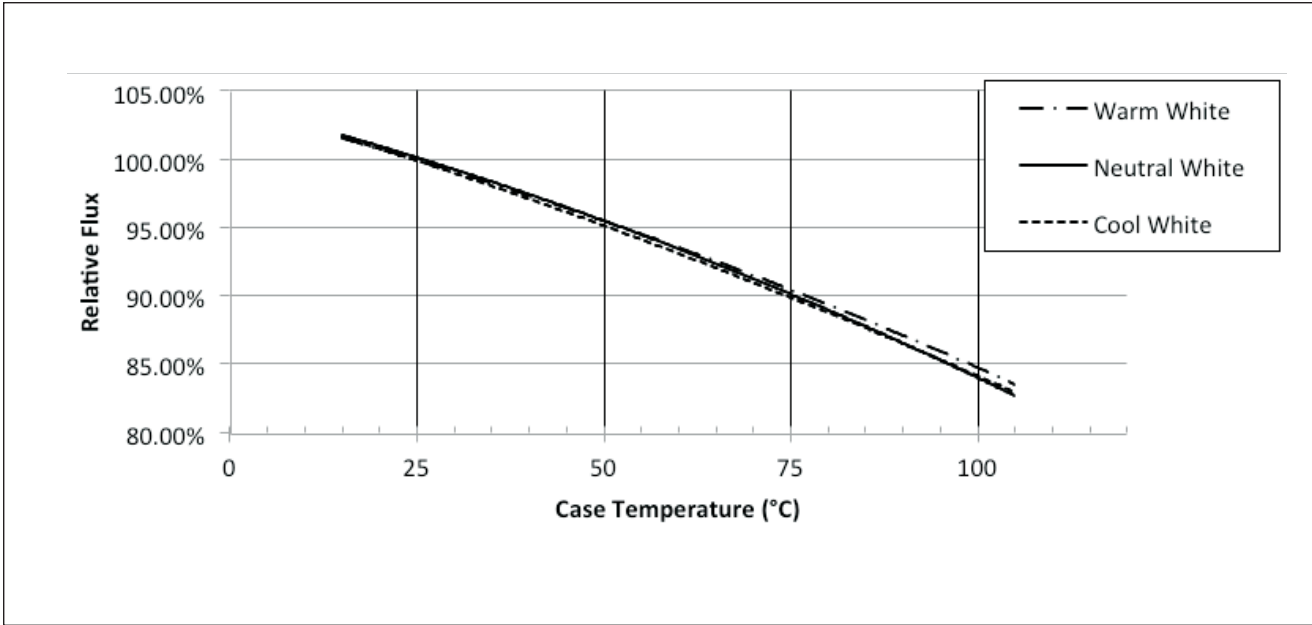
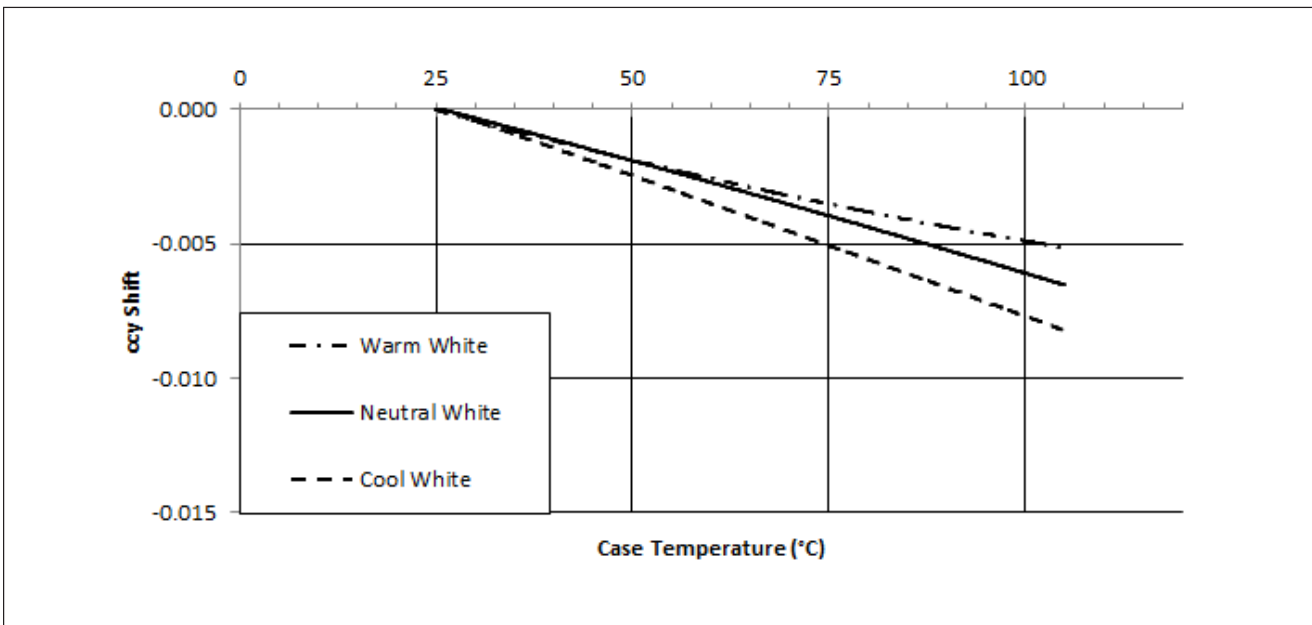

Figure 5: Typical DC ccy Shift vs. Case Temperature



Notes for Figures 4-5:

1. Characteristics shown for warm white based on 3000K and 80 CRI.
2. Characteristics shown for neutral white based on 4000K and 80 CRI.
3. Characteristics shown for cool white based on 5000K and 70 CRI.
4. For other color SKUs, the shift in color will vary. Please contact your Bridgelux Sales Representative for more information.

# Performance Curves

Figure 6: Typical DC ccx Shift vs. Case Temperature

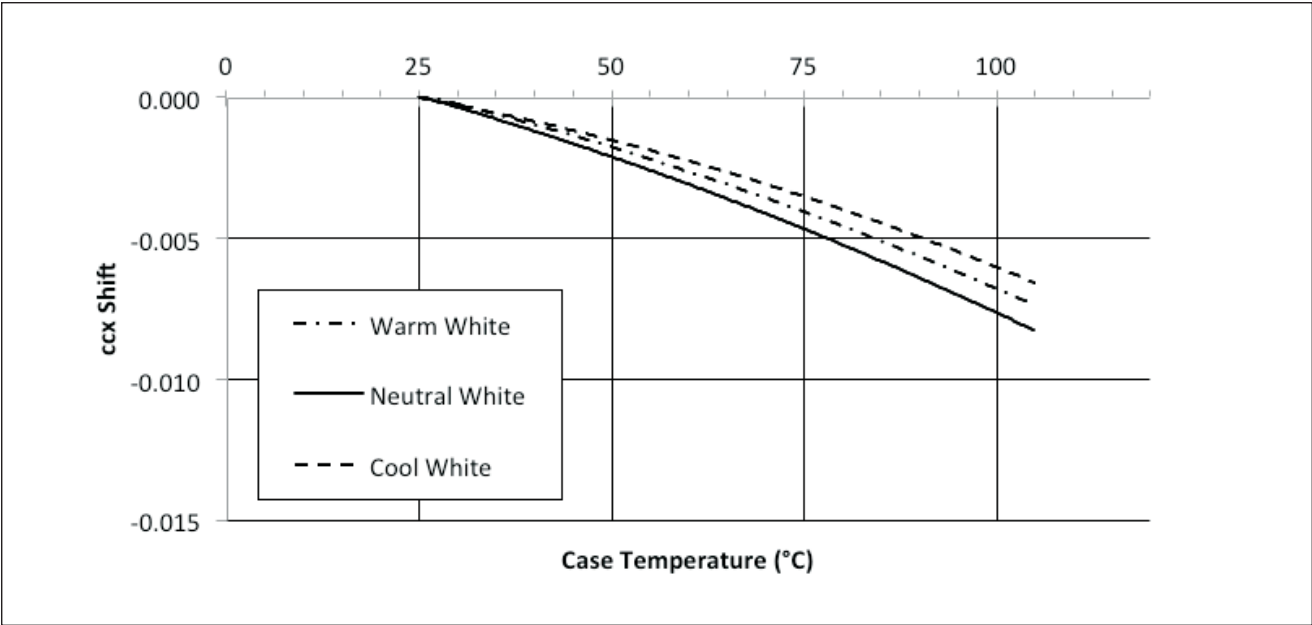

Notes for Figure 6:

- 1. Characteristics shown for warm white based on 3000K and 80 CRI.
- 2. Characteristics shown for neutral white based on 4000K and 80 CRI.
- 3. Characteristics shown for cool white based on 5000K and 70 CRI.
- 4. For other color SKUs, the shift in color will vary. Please contact your Bridgelux Sales Representative for more information.

# Typical Radiation Pattern

Figure 7: Typical Spatial Radiation Pattern

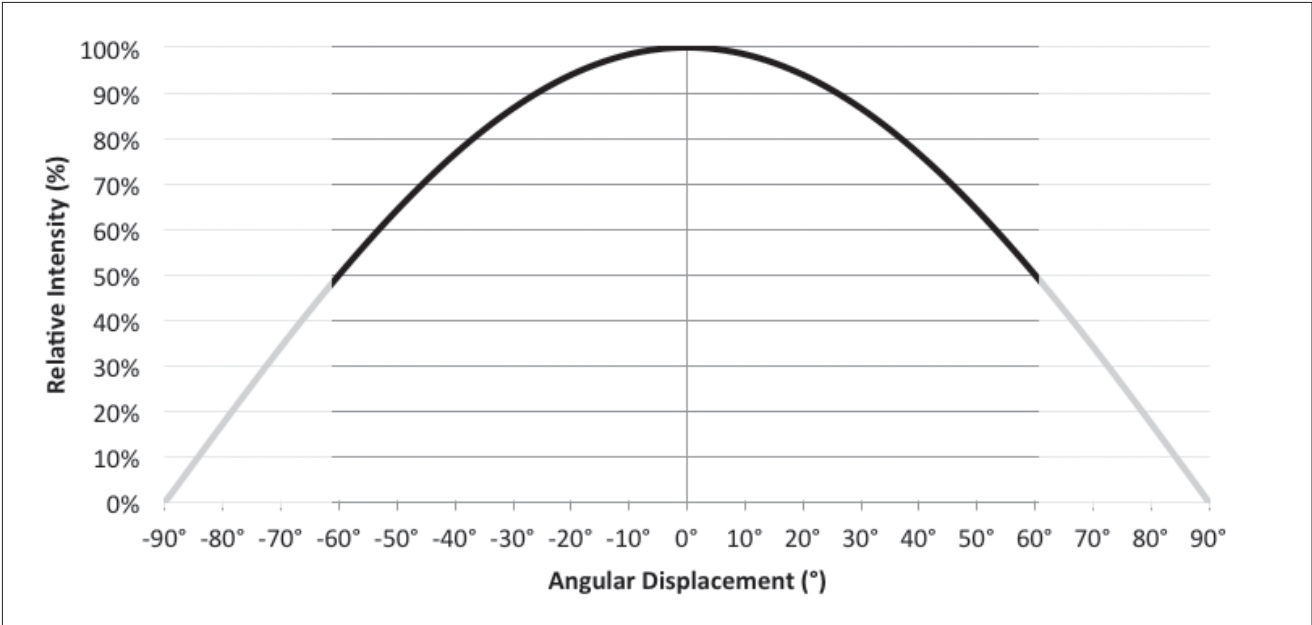

Notes for Figure 7:

- 1. Typical viewing angle is 120°.
- 2. The viewing angle is defined as the off axis angle from the centerline where intensity is 1/2 of the peak value.

Figure 8: Typical Polar Radiation Pattern

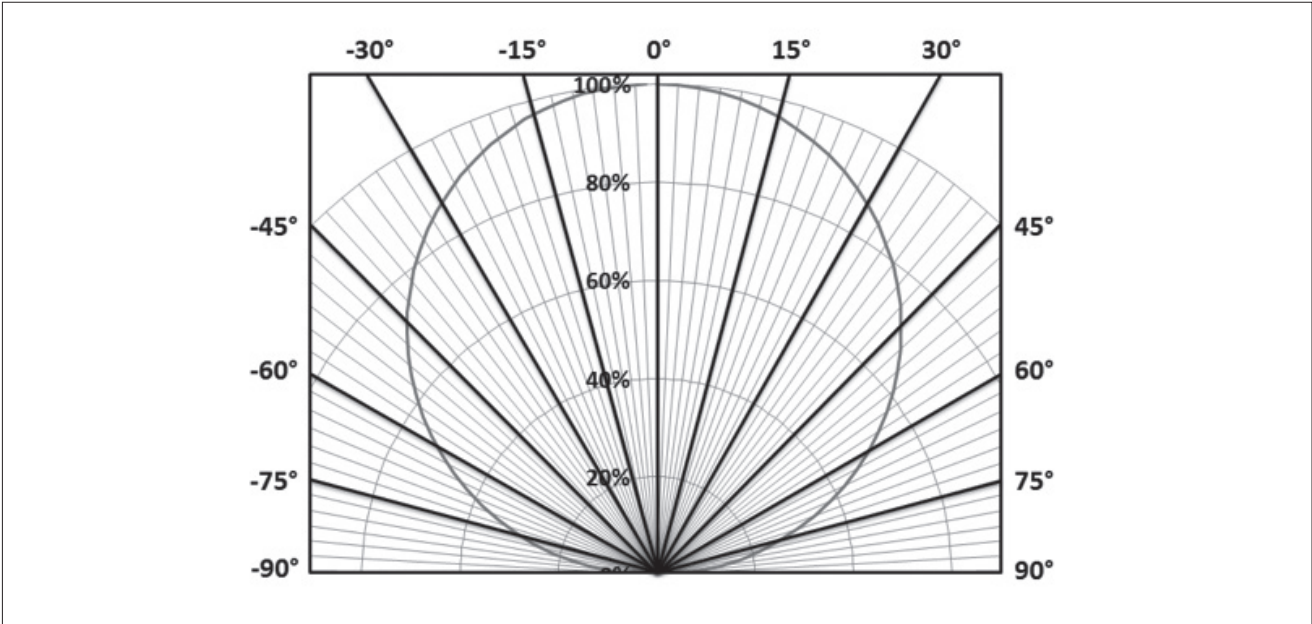

# Typical Color Spectrum

Figure 9: Typical Color Spectrum

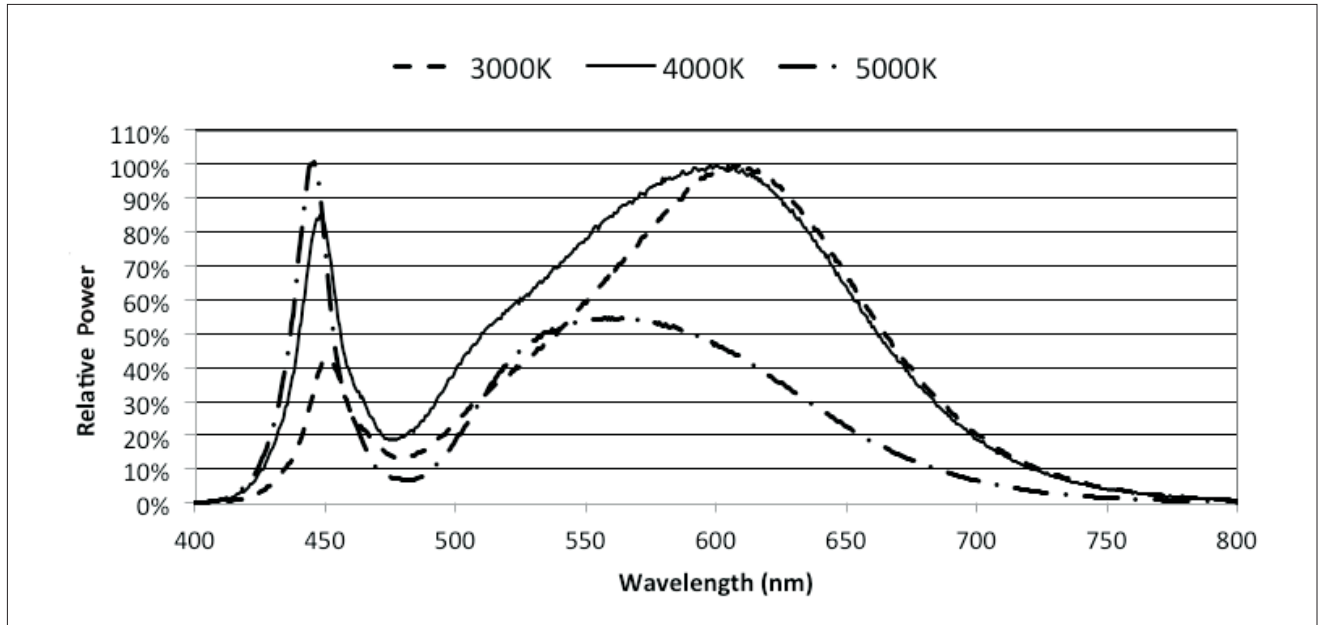

Notes for Figure 9:

1. Color spectra measured at nominal current for  $T_j = T_c = 25^\circ\text{C}$ .
2. Color spectra shown is 3000K and 80 CRI.
3. Color spectra shown is 4000K and 80 CRI.
4. Color spectra shown is 5000K and 70 CRI.

# Mechanical Dimensions

**Figure 10: Drawing for Vero 29 LED Array**

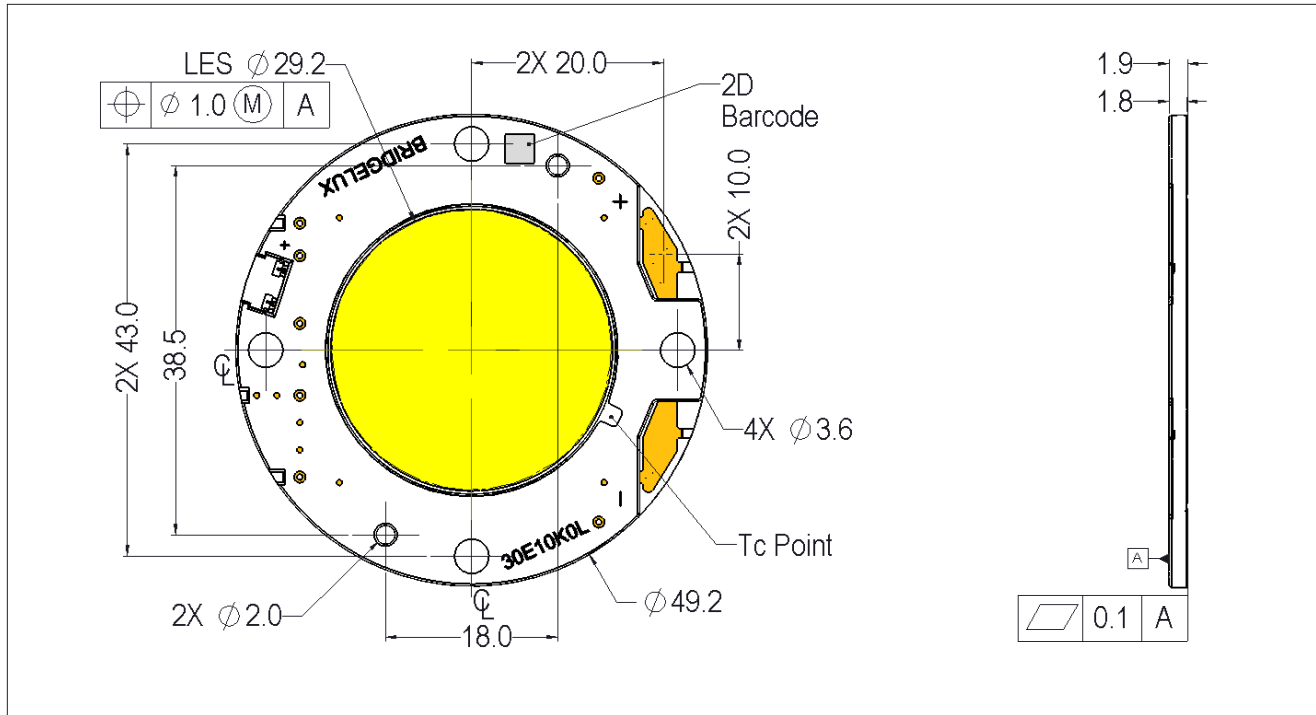

Notes for Figure 10:

1. Drawings are not to scale.
2. Drawing dimensions are in millimeters.
3. Unless otherwise specified, tolerances are  $\pm 0.10\text{mm}$ .
4. Mounting holes (4X) are for M3 screws.
5. Bridgelux recommends four tapped holes for mounting screws with  $43.0 \pm 0.10\text{mm}$  center-to-center spacing.
6. Screws with flat shoulders (pan, dome, button, round, truss, mushroom) provide optimal torque control. Do NOT use flat, countersink, or raised head screws.
7. Solder pads and connector port are labeled "+" and "-" to denote positive and negative, respectively.
8. It is not necessary to provide electrical connections to both the solder pads and the connector port. Either set may be used depending on application specific design requirements.
9. Refer to Application Notes AN30 and AN31 for product handling, mounting and heat sink recommendations.
10. The optical center of the LED Array is nominally defined by the mechanical center of the array to a tolerance of  $\pm 0.2\text{mm}$ .
11. Bridgelux maintains a flatness of 0.10mm across the mounting surface of the array.



# Color Binning Information

**Figure 11: Graph of Warm and Neutral White Test Bins in xy Color Space**

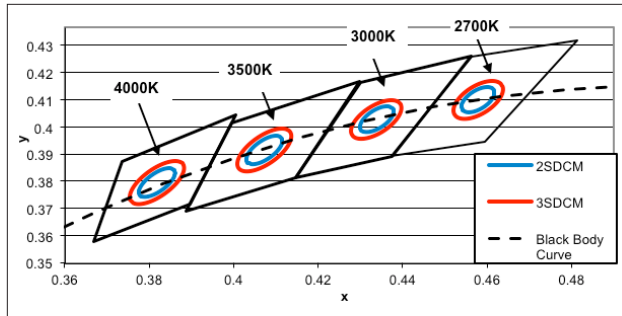

Note: Pulsed Test Conditions,  $T_c = 25^\circ\text{C}$

**Table 6: Warm and Neutral White xy Bin Coordinates and Associated Typical CCT**

Bin Code	2700K	3000K	3500K	4000K
ANSI Bin (for reference only)	(2580K - 2870K)	(2870K - 3220K)	(3220K - 3710K)	(3710K - 4260K)
23 (3SDCM)	(2651K - 2794K)	(2968K - 3136K)	(3369K - 3586K)	(3851K - 4130K)
22 (2SDCM)	(2674K - 2769K)	(2995K - 3107K)	(3404K - 3548K)	(3895K - 4081K)
Center Point (x,y)	(0.4578, 0.4101)	(0.4338, 0.403)	(0.4073, 0.3917)	(0.3818, 0.3797)

**Figure 12: Graph of Cool White Test Bins in xy Color Space**

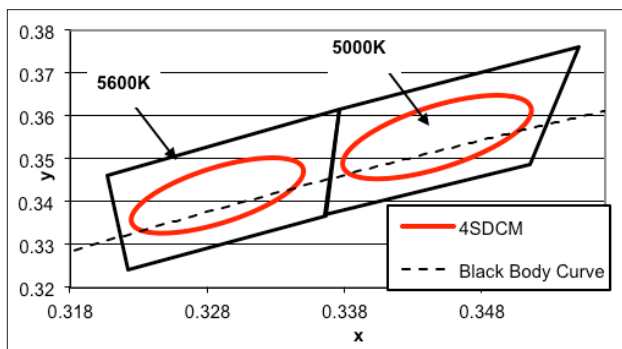

Note: Pulsed Test Conditions,  $T_c = 25^\circ\text{C}$

**Table 7: Cool White xy Bin Coordinates and Associated Typical CCT**

Bin Code	5000K	5600K
ANSI Bin (for reference only)	(4745K - 5311K)	(5310K - 6020K)
24 (4SDCM)	(4801K - 5282K)	(5475K - 5830K)
Center Point (x,y)	(0.3447, 0.3553)	(0.3293, 0.3423)

# Packaging and Labeling

Figure 13: Drawing for Vero 29 Packaging Tray

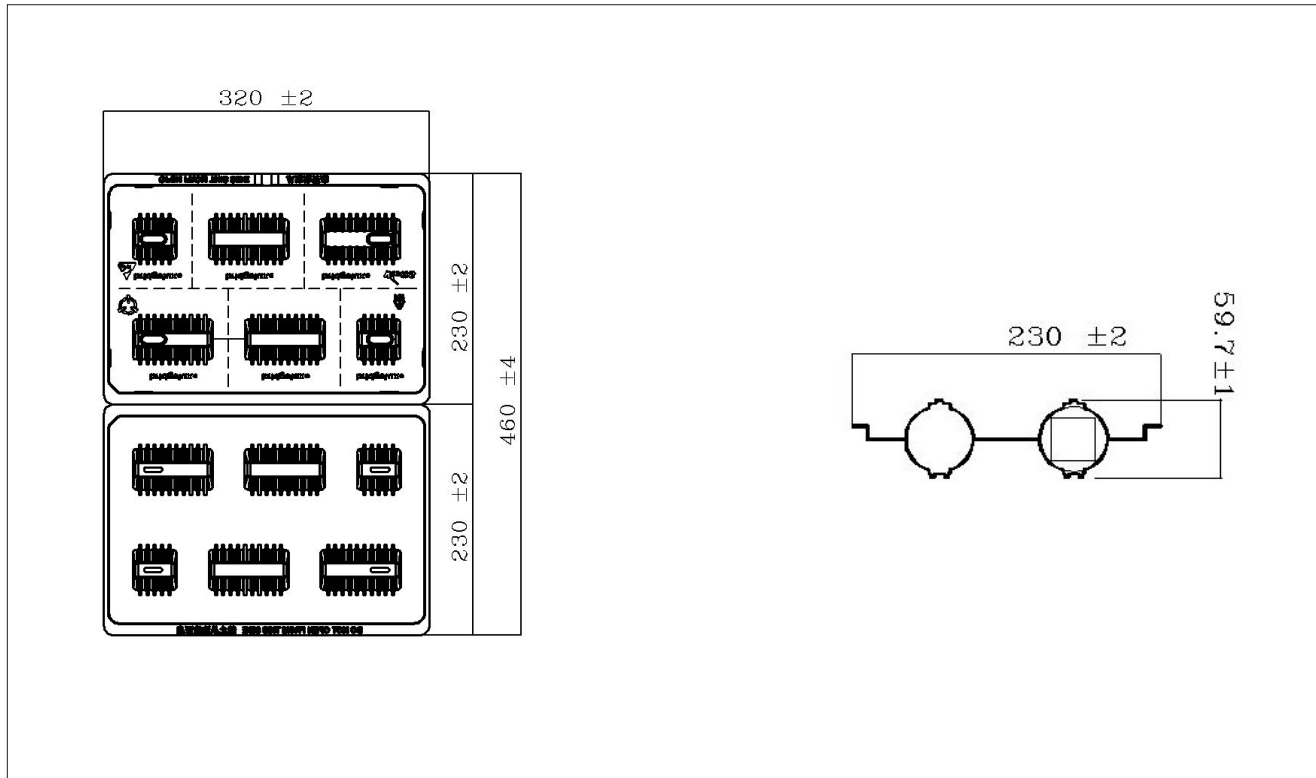

Notes for Figure 13:

1. Dimensions are in millimeters.
2. Drawing is not to scale.

# Packaging and Labeling

**Figure 14: Vero Series Packaging and Labeling**

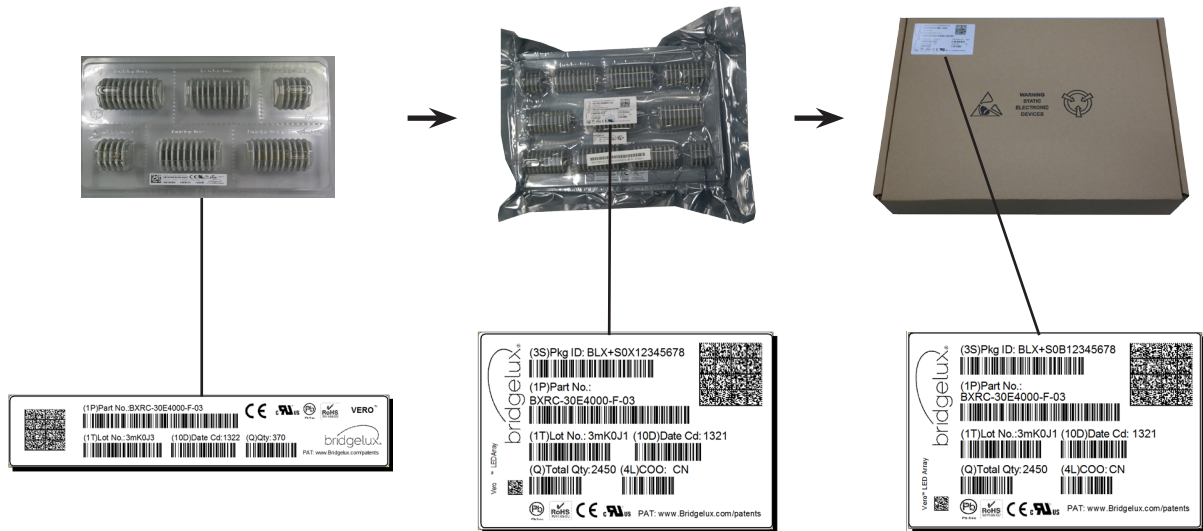

Notes for Figure 14:

1. Each tray holds 50 COBs.
2. Each tray is vacuum sealed in an anti-static bag and placed in its own box.
3. Each tray, bag and box is to be labeled as shown above.

**Figure 15: Product Labeling**

Bridgelux COB arrays have laser markings on the back side of the substrate to help with product identification. In addition to the product identification markings, Bridgelux COB arrays also contain markings for internal Bridgelux manufacturing use only. The image below shows which markings are for customer use and which ones are for Bridgelux internal use only. The Bridgelux internal manufacturing markings are subject to change without notice, however these will not impact the form, function or performance of the COB array.



# Design Resources

## Application Notes

Bridgelux has developed a comprehensive set of application notes and design resources to assist customers in successfully designing with the Vero product family of LED array products. For all available application notes visit [www.bridgelux.com](http://www.bridgelux.com).

## Optical Source Models

Optical source models and ray set files are available for all Bridgelux products. For a list of available formats, visit [www.bridgelux.com](http://www.bridgelux.com).

## 3D CAD Models

Three dimensional CAD models depicting the product outline of all Bridgelux Vero LED arrays are available in both IGS and STEP formats. Please contact your Bridgelux sales representative for assistance.

# Precautions

## CAUTION: CHEMICAL EXPOSURE HAZARD

Exposure to some chemicals commonly used in luminaire manufacturing and assembly can cause damage to the LED array. Please consult Bridgelux Application Note AN31 for additional information.

## CAUTION: EYE SAFETY

Eye safety classification for the use of Bridgelux Vero LED arrays is in accordance with IEC specification EN62471: Photobiological Safety of Lamps and Lamp Systems. Vero LED arrays are classified as Risk Group 1 (Low Risk) when operated at or below the maximum drive current. Please use appropriate precautions. It is important that employees working with LEDs are trained to use them safely.

## CAUTION: RISK OF BURN

Do not touch the Vero LED array during operation. Allow the array to cool for a sufficient period of time before handling. The Vero LED array may reach elevated temperatures such that could burn skin when touched.

## CAUTION

### CONTACT WITH LIGHT EMITTING SURFACE (LES)

Avoid any contact with the LES. Do not touch the LES of the LED array or apply stress to the LES (yellow phosphor resin area). Contact may cause damage to the LED array.

Optics and reflectors must not be mounted in contact with the LES (yellow phosphor resin area). Optical devices may be mounted on the top surface of the plastic housing of the Vero LED array. Use the mechanical features of the LED array housing, edges and/or mounting holes to locate and secure optical devices as needed.

# Disclaimers

## MINOR PRODUCT CHANGE POLICY

The rigorous qualification testing on products offered by Bridgelux provides performance assurance. Slight cosmetic changes that do not affect form, fit, or function may occur as Bridgelux continues product optimization.

## STANDARD TEST CONDITIONS

Unless otherwise stated, array testing is performed at the nominal drive current.

# About Bridgelux: We Build Light That Transforms

At Bridgelux, we help companies, industries and people experience the power and possibility of light. Since 2002, we've designed LED solutions that are high performing, energy efficient, cost effective and easy to integrate. Our focus is on light's impact on human behavior, delivering products that create better environments, experiences and returns—both experiential and financial. And our patented technology drives new platforms for commercial and industrial luminaires.

**For more information about the company, please visit**  
**bridgelux.com**  
**twitter.com/Bridgelux**  
**facebook.com/Bridgelux**  
**WeChat ID: BridgeluxInChina**



101 Portola Avenue  
Livermore, CA 94551  
Tel (925) 583-8400  
Fax (925) 583-8410  
**www.bridgelux.com**

© 2016 Bridgelux, Inc. All rights reserved 2016. Product specifications are subject to change without notice. Bridgelux, the Bridgelux stylized logo design and Vero are registered trademarks, and Decor Series is a trademark of Bridgelux, Inc. All other trademarks are the property of their respective owners.

**Bridgelux Vero 29 Array Series Product Data Sheet DS33 Rev. L (06/2016)**

## X-ON Electronics

Largest Supplier of Electrical and Electronic Components

*Click to view similar products for [bridgelux](#) manufacturer:*

Other Similar products are found below :

[BXRC-30E1000-C-73](#) [BXRC-30G1000-C-73](#) [BXRC-35G4000-B-73](#) [BXRE-30G2000-C-73](#) [BXRE-40E2000-C-73](#) [BXKE-40G1501-B-23](#)  
[BXEM-50C0000-0-000](#) [BXRC-17E10K0-C-74-SE](#) [BXRC-30G10K0-C-72-SE](#) [BXRC-40E2000-B-73](#) [BXRC-56G10K0-D-74](#) [BXRE-](#)  
[27E1000-B-73](#) [BXRE-30G4000-B-73](#) [BXRE-40E2000-B-73](#) [BXRE-40E4000-B-73](#) [BXRE-50C2001-B-74](#) [BXRE-50S1001-C-74](#) [BXEN-](#)  
[27S-11L-3C-00-0-0](#) [BXEN-27S-11M-3C-00-0-0](#) [BXEN-27S-13H-9C-00-0-0](#) [BXEN-30S-11L-3C-00-0-0](#) [BXEN-30S-11M-3C-00-0-0](#) [BXEN-](#)  
[30S-13H-9C-00-0-0](#) [BXEN-35S-11L-3C-00-0-0](#) [BXEN-35S-11M-3C-00-0-0](#) [BXEN-35S-13H-9C-00-0-0](#) [BXEN-40S-11L-3C-00-0-0](#) [BXEN-](#)  
[40S-13H-9C-00-0-0](#) [BXEN-50S-11L-3C-00-0-0](#) [BXEN-50S-13H-9C-00-0-0](#) [BXEN-57S-11L-3C-00-0-0](#) [BXEN-57S-13H-9C-00-0-0](#) [BXRE-](#)  
[30S1001-B-73](#) [BXRE-57S1001-C-74](#) [BXRE-65S1001-C-74](#) [BXDR-30BT-U214P-01-A](#) [BXDR-60BT-U220P-01-A](#) [BXDR-60LT-U220P-01-](#)  
[A](#) [BXRC-30E10K0-D-73-SE](#) [BXKE-27G1501-B-23](#) [BXRV-TR-2765G-30A0-A-23](#) [BXRC-35E4000-F-23](#) [BXRC-30E1000-B-23](#) [BXRC-](#)  
[30E1000-D-73-SE](#) [BXRC-27G2000-C-23](#) [BXRC-27H1000-C-73](#) [BXRH-30E0600-A-73](#) [BXKE-27G0801-A-23](#) [BXKE-30G0801-A-23](#)  
[BXKE-40G0801-A-23](#)