

# Bridgelux® V22 F90 Array Series

Product Data Sheet DS449



# Introduction

V Series



The V Series™ LED Array products deliver high quality light in a compact and cost-effective solid-state lighting package. These chip on board (COB) arrays can be efficiently driven up to two times the nominal drive current, enabling design flexibility not previously possible. These high flux density light sources are designed to support a wide range of high quality, low cost directional luminaires and replacement lamps for both interior and exterior commercial and residential applications.

The F90 V Series COB is a high efficacy product that uses narrow band red phosphor to significantly improve the spectrum efficacy. The improved spectrum efficacy results in the 90 CRI product of the F90 Series delivering better or equivalent efficacy as that of our traditional 80 CRI V Series product.

The V22 LED Array is available in a variety of electrical, CCT, and CRI combinations providing substantial design flexibility and energy efficiency advantages.

Lighting system designs incorporating these LED arrays deliver increased system level efficacy and a longer service life. Typical applications include replacement lamps and task, accent, spot, track, wide area, security, wall packs and down lights.

## Features

- Efficacy of 187 lm/W typical, 3000K 90 CRI
- Wide selection of CCT options (2700K-5000K) with minimum 90 CRI options
- Uniform high-quality illumination
- 2 and 3 SDCM binning options (2700K – 4000K)
- 3 and 4 SDCM binning options (5000K)
- Forward voltage bin codes and backside marking
- Instant light with unlimited dimming
- 5-Year warranty

## Benefits

- Enables high efficiency lighting systems and lower operating costs
- Supports the trend toward luminaire miniaturization and delivers enhanced optical control
- Design flexibility for a broad range of lighting applications
- Clean white light without pixelation
- Uniform consistent white light
- Design flexibility for multi-source applications
- Easy to use with daylight and motion sensors to increase energy savings
- Design with confidence



# Contents

Product Feature Map	2
Product Nomenclature	2
Product Selection Guide	3
European Product Registry for Energy Labeling	5
Performance at Commonly Used Drive Currents	6
Electrical Characteristics	9
Eye Safety	10
Absolute Maximum Ratings	11
Performance Curves	13
Typical Radiation Pattern	15
Typical Color Spectrum	16
Mechanical Dimensions	17
Color Binning Information	18
Packaging and Labeling	19
Design Resources	21
Precautions	21
Disclaimers	21
About Bridgelux	22

# Product Feature Map

Bridgelux arrays are fully engineered devices that provide consistent thermal and optical performance on an engineered mechanical platform. The V Series arrays are the most compact CoB devices across all of Bridgelux's LED Array products.

The arrays incorporate several features to simplify design integration and assembly. Please visit [www.bridgelux.com](http://www.bridgelux.com) for more information on the V Series family of products.

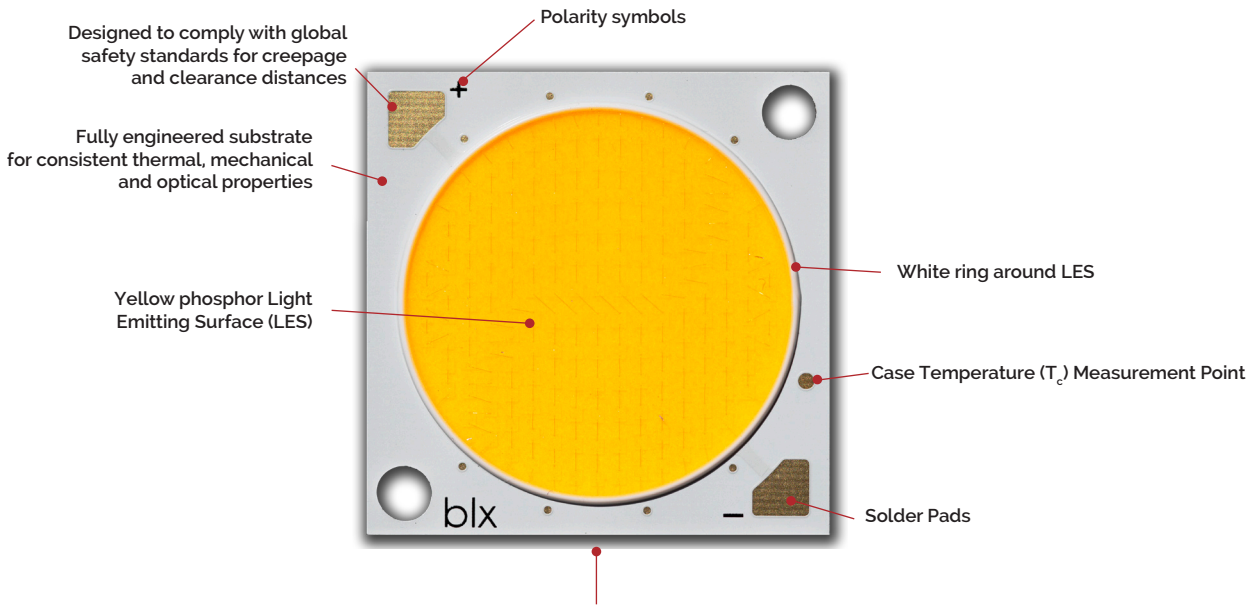

Note: Part number and lot codes are scribed on back of array

## Product Nomenclature

The part number designation for Bridgelux V Series LED arrays is explained as follows:

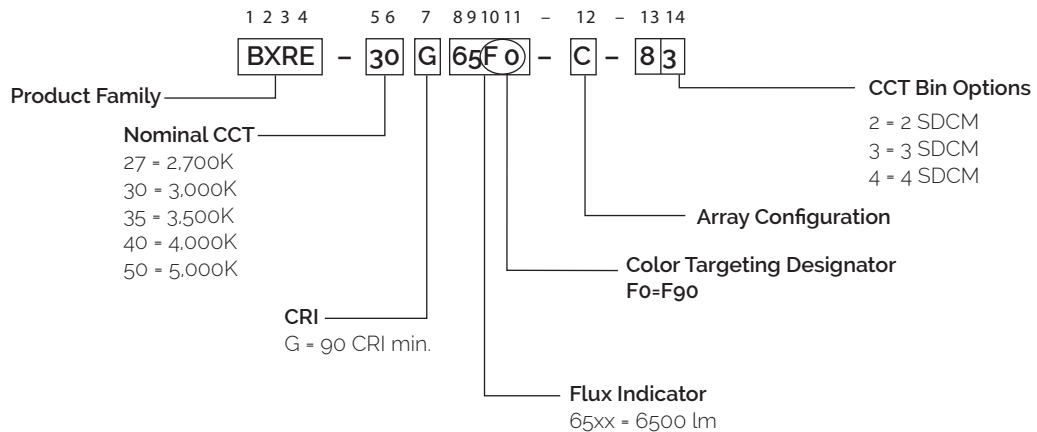

# Product Selection Guide

The following product configurations are available:

**Table 1:** Selection Guide, Pulsed Measurement Data ( $T_j = T_c = 25^\circ\text{C}$ )

Part Number	Nominal CCT <sup>1</sup> (K)	CRI <sup>2</sup>	Nominal Drive Current <sup>3</sup> (mA)	Typical Pulsed Flux <sup>4,5,6</sup> $T_c = 25^\circ\text{C}$ (lm)	Minimum Pulsed Flux <sup>6,7</sup> $T_c = 25^\circ\text{C}$ (lm)	Typical $V_f$ (V)	Typical Power (W)	Typical Efficacy (lm/W)
BXRE-27G65F0-B-8x	2700	90	950	8983	8085	51.6	49.0	183
BXRE-27G65F0-C-8x	2700	90	1200	11312	10180	52.0	62.4	181
BXRE-27G65F0-D-8x	2700	90	1050	6633	5970	34.5	36.2	183
BXRE-30G65F0-B-8x	3000	90	950	9166	8250	51.6	49.0	187
BXRE-30G65F0-C-8x	3000	90	1200	11542	10388	52.0	62.4	185
BXRE-30G65F0-D-8x	3000	90	1050	6769	6092	34.5	36.2	187
BXRE-35G65F0-B-8x	3500	90	950	9258	8332	51.6	49.0	189
BXRE-35G65F0-C-8x	3500	90	1200	11658	10492	52.0	62.4	187
BXRE-35G65F0-D-8x	3500	90	1050	6836	6153	34.5	36.2	189
BXRE-40G65F0-B-8x	4000	90	950	9350	8415	51.6	49.0	191
BXRE-40G65F0-C-8x	4000	90	1200	11773	10596	52.0	62.4	189
BXRE-40G65F0-D-8x	4000	90	1050	6904	6214	34.5	36.2	191
BXRE-50G65F0-B-8x	5000	90	950	9075	8167	51.6	49.0	185
BXRE-50G65F0-C-8x	5000	90	1200	11427	10284	52.0	62.4	183
BXRE-50G65F0-D-8x	5000	90	1050	6701	6031	34.5	36.2	185

Notes for Table 1:

- Nominal CCT as defined by ANSI C78.377-2011.
- CRI values are minimums and tested at  $T_j = T_c = 85^\circ\text{C}$ . Minimum Rg value for 90 CRI products is 50. Bridgelux maintains a  $\pm 3$  tolerance on CRI and Rg values.
- Drive current is referred to as nominal drive current.
- Products tested under pulsed condition (10ms pulse width) at nominal test current where  $T_j$  (junction temperature) =  $T_c$  (case temperature) =  $25^\circ\text{C}$ .
- Typical performance values are provided as a reference only and are not a guarantee of performance.
- Bridgelux maintains a  $\pm 7\%$  tolerance on flux measurements.
- Minimum flux values at the nominal test current are guaranteed by 100% test.

# Product Selection Guide

**Table 2:** Selection Guide, Stabilized DC Performance ( $T_c = 85^\circ\text{C}$ )<sup>4,5</sup>

Part Number	Nominal CCT <sup>1</sup> (K)	CRI <sup>2</sup>	Nominal Drive Current <sup>3</sup> (mA)	Typical DC Flux <sup>4,5</sup> $T_c = 85^\circ\text{C}$ (lm)	Minimum DC Flux <sup>6</sup> $T_c = 85^\circ\text{C}$ (lm)	Typical $V_f$ (V)	Typical Power (W)	Typical Efficacy (lm/W)
BXRE-27G65F0-B-8x	2700	90	950	8265	7438	50.4	479	173
BXRE-27G65F0-C-8x	2700	90	1200	10407	9366	50.8	61.0	171
BXRE-27G65F0-D-8x	2700	90	1050	6103	5492	33.7	35.4	173
BXRE-30G65F0-B-8x	3000	90	950	8433	7590	50.4	479	176
BXRE-30G65F0-C-8x	3000	90	1200	10619	9557	50.8	61.0	174
BXRE-30G65F0-D-8x	3000	90	1050	6227	5605	33.7	35.4	176
BXRE-35G65F0-B-8x	3500	90	950	8518	7666	50.4	479	178
BXRE-35G65F0-C-8x	3500	90	1200	10725	9653	50.8	61.0	176
BXRE-35G65F0-D-8x	3500	90	1050	6290	5661	33.7	35.4	178
BXRE-40G65F0-B-8x	4000	90	950	8602	7742	50.4	479	180
BXRE-40G65F0-C-8x	4000	90	1200	10831	9748	50.8	61.0	178
BXRE-40G65F0-D-8x	4000	90	1050	6352	5717	33.7	35.4	180
BXRE-50G65F0-B-8x	5000	90	950	8349	7514	50.4	479	174
BXRE-50G65F0-C-8x	5000	90	1200	10513	9462	50.8	61.0	172
BXRE-50G65F0-D-8x	5000	90	1050	6165	5548	33.7	35.4	174

Notes for Table 2:

1. Nominal CCT as defined by ANSI C78.377-2011.
2. CRI values are minimums and tested at  $T_j = T_c = 85^\circ\text{C}$ . Minimum R<sub>g</sub> value for 90 CRI products is 50.
3. Drive current is referred to as nominal drive current.
4. Typical stabilized DC performance values are provided as reference only and are not a guarantee of performance.
5. Typical performance is estimated based on operation under DC (direct current) with LED array mounted onto a heat sink with thermal interface material and the case temperature maintained at  $85^\circ\text{C}$ . Based on Bridgelux test setup, values may vary depending on the thermal design of the luminaire and/or the exposed environment to which the product is subjected.
6. Minimum flux values at elevated temperatures are provided for reference only and are not guaranteed by 100% production testing. Based on Bridgelux test setup, values may vary depending on the thermal design of the luminaire and/or the exposed environment to which the product is subjected.

# European Product Registry for Energy Labeling

The European Product Registry for Energy Labeling (EPREL) is defined in the EU Regulation 2017/1369 to provide important energy efficiency information to consumers. Together with Energy Labeling Regulation ELR (EU) 2019/2015 which was amended by regulation (EU) 2021/340 for energy labelling of light sources, manufacturers are required to declare an energy class based on key technical specifications from each of their product and register it in an open data base managed by EPREL. It is now a legal requirement for a vendor of light sources to upload information about their products into the EPREL database before placing these products on the market in the EU.

Table 3 below provides a list of part numbers that are in compliance with ELR and are currently listed in the EPREL database.

At Bridgelux, we are fully committed to supplying products that are compliant with pertinent laws, rules, and obligation imposed by relevant government bodies including the European Energy Labeling regulation. Customers can use these products with full confidence for any projects that fall under the ELR.

**Table 3:** Part numbers registered in European Product Registry for Energy Labeling

PART NUMBER <sup>1</sup>	CCT (K)	CRI	Current <sup>2</sup> (mA)	Vf (V)	Useful flux <sup>3</sup> ( $\Phi_{use}$ ) at 85C (lm)	Power (W)	Efficacy (lm/W)	Energy efficiency class <sup>4</sup> 	Registration No	URL to Product Information Sheet in EPREL Database
BXRE-27G65Fo-D-83	2700	90	2520	38.0	12946	95.7	135	E	1181975	<a href="https://eprelec.europa.eu/qr/1181975">https://eprelec.europa.eu/qr/1181975</a>
BXRE-27G65Fo-B-83	2700	90	2340	57.0	17956	133.4	135	E	1181973	<a href="https://eprelec.europa.eu/qr/1181973">https://eprelec.europa.eu/qr/1181973</a>
BXRE-27G65Fo-C-83	2700	90	2700	57.0	20808	153.9	135	E	1181974	<a href="https://eprelec.europa.eu/qr/1181974">https://eprelec.europa.eu/qr/1181974</a>
BXRE-30G65Fo-D-83	3000	90	2520	38.0	13210	95.7	138	E	1181978	<a href="https://eprelec.europa.eu/qr/1181978">https://eprelec.europa.eu/qr/1181978</a>
BXRE-30G65Fo-B-83	3000	90	2340	57.0	18322	133.4	137	E	1181976	<a href="https://eprelec.europa.eu/qr/1181976">https://eprelec.europa.eu/qr/1181976</a>
BXRE-30G65Fo-C-83	3000	90	2700	57.0	21233	153.9	138	E	1181977	<a href="https://eprelec.europa.eu/qr/1181977">https://eprelec.europa.eu/qr/1181977</a>
BXRE-35G65Fo-D-83	3500	90	2520	38.0	13342	95.7	139	E	1181983	<a href="https://eprelec.europa.eu/qr/1181983">https://eprelec.europa.eu/qr/1181983</a>
BXRE-35G65Fo-B-83	3500	90	2340	57.0	18505	133.4	139	E	1181980	<a href="https://eprelec.europa.eu/qr/1181980">https://eprelec.europa.eu/qr/1181980</a>
BXRE-35G65Fo-C-83	3500	90	2700	57.0	21445	153.9	139	E	1181981	<a href="https://eprelec.europa.eu/qr/1181981">https://eprelec.europa.eu/qr/1181981</a>
BXRE-40G65Fo-D-83	4000	90	2520	38.0	13474	95.7	141	E	1181986	<a href="https://eprelec.europa.eu/qr/1181986">https://eprelec.europa.eu/qr/1181986</a>
BXRE-40G65Fo-B-83	4000	90	2340	57.0	18688	133.4	140	E	1181984	<a href="https://eprelec.europa.eu/qr/1181984">https://eprelec.europa.eu/qr/1181984</a>
BXRE-40G65Fo-C-83	4000	90	2700	57.0	21657	153.9	141	E	1181985	<a href="https://eprelec.europa.eu/qr/1181985">https://eprelec.europa.eu/qr/1181985</a>
BXRE-50G65Fo-D-84	5000	90	2520	38.0	13078	95.7	137	E	1181989	<a href="https://eprelec.europa.eu/qr/1181989">https://eprelec.europa.eu/qr/1181989</a>
BXRE-50G65Fo-B-84	5000	90	2340	57.0	18139	133.4	136	E	1181987	<a href="https://eprelec.europa.eu/qr/1181987">https://eprelec.europa.eu/qr/1181987</a>
BXRE-50G65Fo-C-84	5000	90	2700	57.0	21020	153.9	137	E	1181988	<a href="https://eprelec.europa.eu/qr/1181988">https://eprelec.europa.eu/qr/1181988</a>

Notes for Table 3:

1. All device listed here must be disposed as e-waste upon its end of life according to local country guideline in each country.
2. For information on performance values at alternative drive conditions, please refer to the Product Selection Guide, Absolute Maximum Rating Table and Performance Curves in this data sheet.
3. For a definition of useful luminous flux ( $\Phi_{use}$ ), please see the ELR regulations at <https://tinyurl.com/4b6zvt4m>.
4. EPREL requires an arrow symbol containing the letter of the energy efficiency class to be displayed, on technical promotional material. Refer to this energy efficiency class column for specific energy efficiency class on each part number.

# Performance at Commonly Used Drive Currents

V Series LED arrays are tested to the specifications shown using the nominal drive currents in Table 1. V Series may also be driven at other drive currents dependent on specific application design requirements. The performance at any drive current can be derived from the current vs. voltage characteristics shown in Figures 1, 2 & 3 and the flux vs. current characteristics shown in Figures 4, 5 & 6. The performance at commonly used drive currents is summarized in Table 4.

**Table 4:** Product Performance at Commonly Used Drive Currents

Part Number	CRI	Drive Current <sup>1</sup> (mA)	Typical $V_f$ $T_c = 25^\circ\text{C}$ (V)	Typical Power $T_c = 25^\circ\text{C}$ (W)	Typical Flux <sup>2</sup> $T_c = 25^\circ\text{C}$ (lm)	Typical DC Flux <sup>3</sup> $T_c = 85^\circ\text{C}$ (lm)	Typical Efficacy $T_c = 25^\circ\text{C}$ (lm/W)
BXRE-27G65F0-B-8x	90	475	49.4	23.4	4624	4314	197
		725	50.6	36.7	6945	6434	189
		<b>950</b>	<b>51.6</b>	<b>49.0</b>	<b>8983</b>	<b>8265</b>	<b>183</b>
		1170	52.6	61.5	10931	9983	178
		1900	55.6	105.6	17068	15152	162
		2340	57.2	133.8	20002	17401	150
BXRE-27G65F0-C-8x	90	600	49.6	29.7	5833	5443	196
		900	50.8	45.7	8609	7979	188
		<b>1200</b>	<b>52.0</b>	<b>62.4</b>	<b>11312</b>	<b>10407</b>	<b>181</b>
		1440	52.9	76.2	13421	12270	176
		2400	56.2	134.9	21392	18990	159
		2700	57.2	154.3	23729	20843	154
BXRE-27G65F0-D-8x	90	525	32.9	17.3	3412	3183	197
		785	33.7	26.5	5023	4655	190
		<b>1050</b>	<b>34.5</b>	<b>36.2</b>	<b>6633</b>	<b>6103</b>	<b>183</b>
		1400	35.4	49.6	8678	7898	175
		2100	37.2	78.1	12571	11160	161
		2520	38.1	96.0	14770	12887	154
BXRE-30G65F0-B-8x	90	475	49.4	23.4	4719	4403	201
		725	50.6	36.7	7086	6565	193
		<b>950</b>	<b>51.6</b>	<b>49.0</b>	<b>9166</b>	<b>8433</b>	<b>187</b>
		1170	52.6	61.5	11154	10186	181
		1900	55.6	105.6	17417	15461	165
		2340	57.2	133.8	20411	17756	153
BXRE-30G65F0-C-8x	90	600	49.6	29.7	5952	5554	200
		900	50.8	45.7	8785	8141	192
		<b>1200</b>	<b>52.0</b>	<b>62.4</b>	<b>11542</b>	<b>10619</b>	<b>185</b>
		1440	52.9	76.2	13695	12520	180
		2400	56.2	134.9	21828	19378	162
		2700	57.2	154.3	24213	21268	157
BXRE-30G65F0-D-8x	90	525	32.9	17.3	3481	3248	201
		785	33.7	26.5	5125	4750	194
		<b>1050</b>	<b>34.5</b>	<b>36.2</b>	<b>6769</b>	<b>6227</b>	<b>187</b>
		1400	35.4	49.6	8855	8059	179
		2100	37.2	78.1	12827	11387	164
		2520	38.1	96.0	15072	13150	157

Notes for Table 4:

1. Alternate drive currents in Table 4 are provided for reference only and are not a guarantee of performance.
2. Bridgelux maintains a  $\pm 7\%$  tolerance on flux measurements.
3. Typical stabilized DC performance values are provided as reference only and are not a guarantee of performance.



# Performance at Commonly Used Drive Currents

**Table 4:** Product Performance at Commonly Used Drive Currents (Continued)

Part Number	CRI	Drive Current <sup>1</sup> (mA)	Typical V <sub>f</sub> T <sub>c</sub> = 25°C (V)	Typical Power T <sub>c</sub> = 25°C (W)	Typical Flux <sup>2</sup> T <sub>c</sub> = 25°C (lm)	Typical DC Flux <sup>3</sup> T <sub>c</sub> = 85°C (lm)	Typical Efficacy T <sub>c</sub> = 25°C (lm/W)
BXRE-35G65F0-B-8x	90	475	49.4	23.4	4766	4447	203
		725	50.6	36.7	7157	6631	195
		<b>950</b>	<b>51.6</b>	<b>49.0</b>	<b>9258</b>	<b>8518</b>	<b>189</b>
		1170	52.6	61.5	11265	10288	183
		1900	55.6	105.6	17591	15616	167
		2340	57.2	133.8	20615	17934	154
BXRE-35G65F0-C-8x	90	600	49.6	29.7	6012	5609	202
		900	50.8	45.7	8873	8223	194
		<b>1200</b>	<b>52.0</b>	<b>62.4</b>	<b>11658</b>	<b>10725</b>	<b>187</b>
		1440	52.9	76.2	13832	12645	182
		2400	56.2	134.9	22047	19571	163
		2700	57.2	154.3	24456	21481	158
BXRE-35G65F0-D-8x	90	525	32.9	17.3	3516	3281	203
		785	33.7	26.5	5177	4798	196
		<b>1050</b>	<b>34.5</b>	<b>36.2</b>	<b>6836</b>	<b>6290</b>	<b>189</b>
		1400	35.4	49.6	8943	8140	180
		2100	37.2	78.1	12956	11501	166
		2520	38.1	96.0	15222	13281	159
BXRE-40G65F0-B-8x	90	475	49.4	23.4	4813	4491	205
		725	50.6	36.7	7228	6696	197
		<b>950</b>	<b>51.6</b>	<b>49.0</b>	<b>9350</b>	<b>8602</b>	<b>191</b>
		1170	52.6	61.5	11377	10390	185
		1900	55.6	105.6	17765	15771	168
		2340	57.2	133.8	20819	18112	156
BXRE-40G65F0-C-8x	90	600	49.6	29.7	6071	5665	204
		900	50.8	45.7	8960	8304	196
		<b>1200</b>	<b>52.0</b>	<b>62.4</b>	<b>11773</b>	<b>10831</b>	<b>189</b>
		1440	52.9	76.2	13969	12771	183
		2400	56.2	134.9	22265	19765	165
		2700	57.2	154.3	24698	21693	160
BXRE-40G65F0-D-8x	90	525	32.9	17.3	3551	3313	205
		785	33.7	26.5	5228	4845	198
		<b>1050</b>	<b>34.5</b>	<b>36.2</b>	<b>6904</b>	<b>6352</b>	<b>191</b>
		1400	35.4	49.6	9032	8221	182
		2100	37.2	78.1	13084	11615	168
		2520	38.1	96.0	15373	13413	160
BXRE-50G65F0-B-8x	90	475	49.4	23.4	4671	4358	199
		725	50.6	36.7	7016	6499	191
		<b>950</b>	<b>51.6</b>	<b>49.0</b>	<b>9075</b>	<b>8349</b>	<b>185</b>
		1170	52.6	61.5	11042	10084	179
		1900	55.6	105.6	17243	15307	163
		2340	57.2	133.8	20207	17579	151

Notes for Table 4:

1. Alternate drive currents in Table 4 are provided for reference only and are not a guarantee of performance.
2. Bridgelux maintains a ± 7% tolerance on flux measurements.
3. Typical stabilized DC performance values are provided as reference only and are not a guarantee of performance.

# Performance at Commonly Used Drive Currents

**Table 4:** Product Performance at Commonly Used Drive Currents (Continued)

Part Number	CRI	Drive Current <sup>1</sup> (mA)	Typical $V_f$ $T_c = 25^\circ\text{C}$ (V)	Typical Power $T_c = 25^\circ\text{C}$ (W)	Typical Flux <sup>2</sup> $T_c = 25^\circ\text{C}$ (lm)	Typical DC Flux <sup>3</sup> $T_c = 85^\circ\text{C}$ (lm)	Typical Efficacy $T_c = 25^\circ\text{C}$ (lm/W)
BXRE-50G65Fo-C-8x	90	600	49.6	29.7	5893	5498	198
		900	50.8	45.7	8697	8060	190
		<b>1200</b>	<b>52.0</b>	<b>62.4</b>	<b>11427</b>	<b>10513</b>	<b>183</b>
		1440	52.9	76.2	13558	12395	178
		2400	56.2	134.9	21610	19184	160
		2700	57.2	154.3	23971	21055	155
BXRE-50G65Fo-D-8x	90	525	32.9	17.3	3447	3216	199
		785	33.7	26.5	5074	4703	192
		<b>1050</b>	<b>34.5</b>	<b>36.2</b>	<b>6701</b>	<b>6165</b>	<b>185</b>
		1400	35.4	49.6	8766	7979	177
		2100	37.2	78.1	12699	11273	163
		2520	38.1	96.0	14921	13018	155

Notes for Table 4:

1. Alternate drive currents in Table 4 are provided for reference only and are not a guarantee of performance.
2. Bridgelux maintains a  $\pm 7\%$  tolerance on flux measurements.
3. Typical stabilized DC performance values are provided as reference only and are not a guarantee of performance.

# Electrical Characteristics

**Table 5:** Electrical Characteristics

Part Number	Drive Current (mA)	Forward Voltage Pulsed, $T_c = 25^\circ\text{C}$ (V) <sup>1, 2, 3, 8</sup>			Typical Coefficient of Forward Voltage <sup>4</sup> $\Delta V_f / \Delta T_c$ (mV/ $^\circ\text{C}$ )	Typical Thermal Resistance Junction to Case <sup>5,6</sup> $R_{j-c}$ ( $^\circ\text{C}/\text{W}$ )	Driver Selection Voltages <sup>7</sup> (V)	
		Minimum	Typical	Maximum			$V_f$ Min. Hot $T_c = 95^\circ\text{C}$ (V)	$V_f$ Max. Cold $T_c = -40^\circ\text{C}$ (V)
BXRE-xxx65F0-B-8x	950	48.5	51.6	54.7	-17	0.07	47.3	55.8
	2340	53.7	57.2	60.6	-19	0.13	52.4	61.8
BXRE-xxx65F0-C-8x	1200	48.9	52.0	55.1	-17	0.08	47.7	56.2
	2700	53.7	57.2	60.6	-19	0.15	52.4	61.8
BXRE-xxx65F0-D-8x	1050	32.4	34.5	36.5	-11	0.08	31.6	37.3
	2520	35.8	38.1	40.4	-13	0.14	34.9	41.2

Notes for Table 5:

- Parts are tested in pulsed conditions.  $T_c = 25^\circ\text{C}$ . Pulse width is 10ms.
- Voltage minimum and maximum are provided for reference only and are not a guarantee of performance.
- Bridgelux maintains a tester tolerance of  $\pm 0.10\text{V}$  on forward voltage measurements.
- Typical coefficient of forward voltage tolerance is  $\pm 0.1\text{mV}$  for nominal current.
- Thermal resistance values are based from test data of a 3000K 90 CRI product.
- Thermal resistance value was calculated using total electrical input power; optical power was not subtracted from input power. The thermal interface material used during testing is not included in the thermal resistance value.
- $V_f$  min hot and max cold values are provided as reference only and are not guaranteed by test. These values are provided to aid in driver design and selection over the operating range of the product.
- This product has been designed and manufactured per IEC 62031:2018. This product has passed dielectric withstand voltage testing at 1140 V. The working voltage designated for the insulation is 70V d.c. The maximum allowable voltage across the array must be determined in the end product application.

# Eye Safety

**Table 6:** Eye Safety Risk Group (RG) Classifications

Part Number	Drive Current (mA)	CCT <sup>4</sup>		
		2700K/3000K	4000K <sup>2</sup>	5000K <sup>3</sup>
BXRE-xxx65F0-B-8x	1900	RG1	RG1	RG1
	2340	RG1	RG1	RG2
BXRE-xxx65F0-C-8x	1880	RG1	RG1	RG1
	2500	RG1	RG1	RG2
	2700	RG1	RG2	RG2
BXRE-xxx65F0-D-8x	2520	RG1	RG1	RG1

Notes for Table 6:

1. Eye safety classification for the use of Bridgelux V Series LED arrays is in accordance with specification IEC/TR 62778: Application of IEC 62471 for the assessment of blue light hazard to light sources and luminaires.
2. For products classified as RG2 at 4000K, Ethr= 1980 lx.
3. For products classified as RG2 at 5000K Ethr= 1530 lx.
4. Please contact your Bridgelux sales representative for Ethr values at specific drive currents and CCTs not listed.

# Absolute Maximum Ratings

**Table 7:** Maximum Ratings

Parameter	Maximum Rating		
LED Junction Temperature (T <sub>J</sub> )	150°C		
Storage Temperature <sup>1</sup>	-40°C to +95°C		
Operating Case Temperature <sup>2</sup> (T <sub>C</sub> )	95°C		
Soldering Temperature <sup>3</sup>	300°C or lower for a maximum of 6 seconds		
	BXRE-xxx65Fo-B-8x	BXRE-xxx65Fo-C-8x	BXRE-xxx65Fo-D-8x
Maximum Drive Current <sup>4</sup>	2340 mA at ≤85°C 1755 mA at 95°C	2700 mA at ≤85°C 2025 mA at 95°C	2520 mA at ≤85°C 1890 mA at 95°C
Maximum Peak Pulsed Drive Current <sup>5</sup>	3350 mA	3870 mA	3610mA
Maximum Reverse Voltage <sup>6</sup>	-90V	-90V	-50V

Notes for Table 7:

1. The Fg0 product is robust enough to pass our internal humidity test but it is still more sensitive to moisture compared to our regular LED array product. The product needs to be stored in a dry environment. It is not recommended to use the product in a damp environment that is directly exposed to moisture.
2. For IEC 62717 requirement, please consult your Bridgelux sales representative.
3. Refer to Bridgelux Application Note AN101: Handling and Assembly of Bridgelux V Series LED Arrays
4. Arrays may be driven at higher currents however lumen maintenance may be reduced and warranty will not apply.
5. Bridgelux recommends a maximum duty cycle of 10% and pulse width of 20 ms when operating LED Arrays at maximum peak pulsed current specified. Maximum peak pulsed currents indicate values where LED Arrays can be driven without catastrophic failures.
6. Light emitting diodes are not designed to be driven in reverse voltage and will not produce light under this condition. Maximum rating provided for reference only.

# Performance Curves

**Figure 1: V22B Drive Current vs. Voltage**

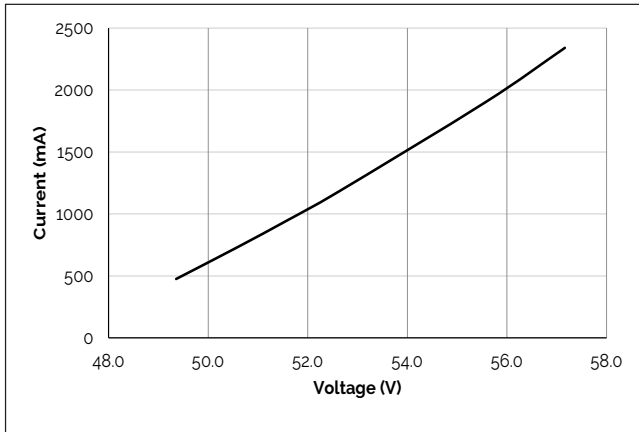

**Figure 2: V22C Drive Current vs. Voltage**

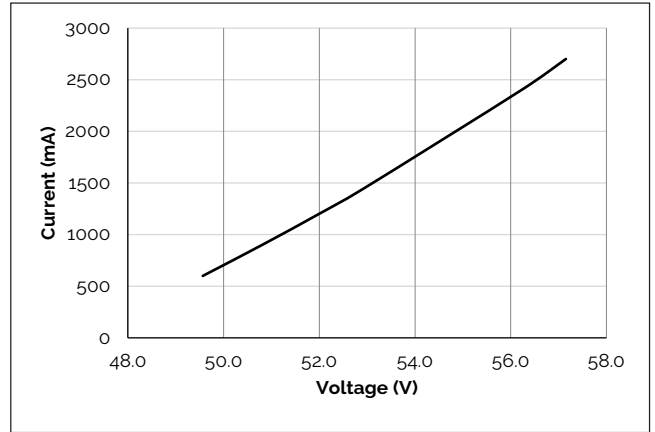

**Figure 3: V22D Drive Current vs. Voltage**

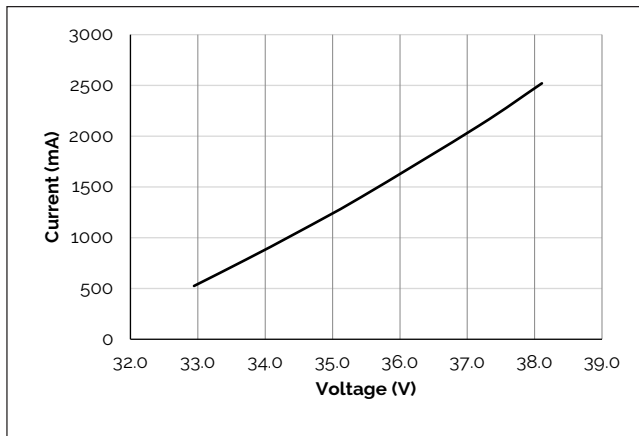

**Figure 4: V22B Typical Relative Flux vs. Current**

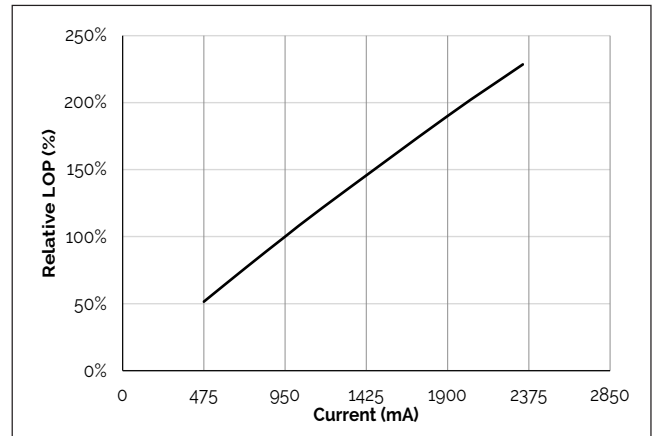

**Figure 5: V22C Typical Relative Flux vs. Current**

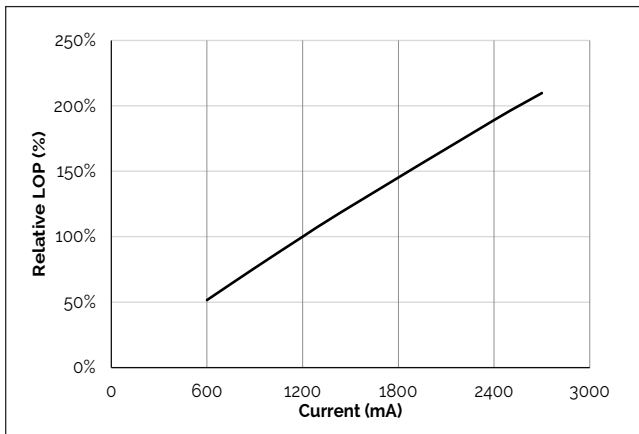

**Figure 6: V22D Typical Relative Flux vs. Current**

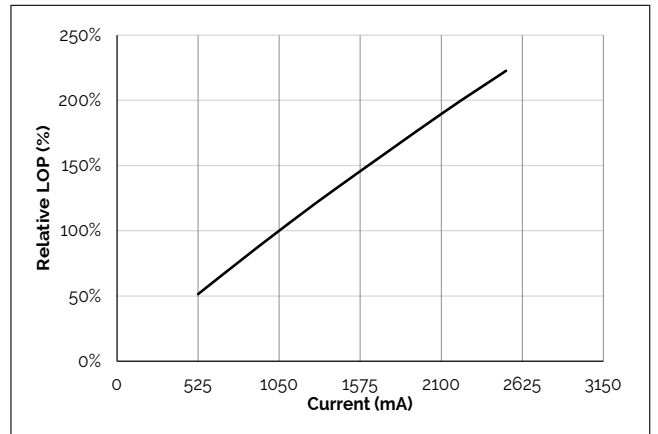

Notes for Figures 1-6:

1. Bridgelux does not recommend driving high power LEDs at low currents. Doing so may produce unpredictable results. Pulse width modulation (PWM) is recommended for dimming effects.
2. Products tested under pulsed condition (10ms pulse width) at nominal test current where  $T_j$  (junction temperature) -  $T_c$  (case temperature) = 25°C.

# Performance Curves

**Figure 7: Typical DC Flux vs. Case Temperature**

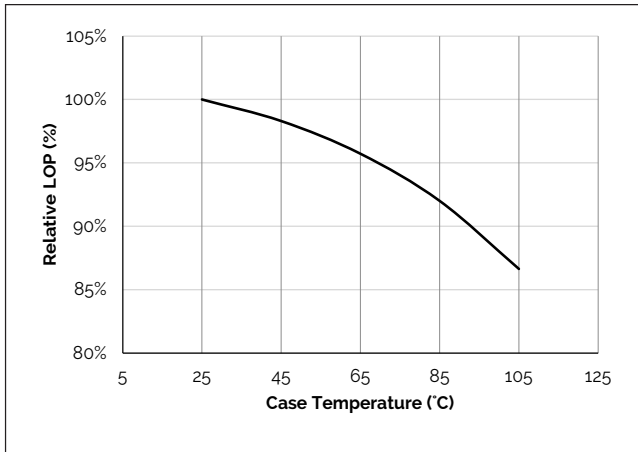

**Figure 8: Typical DC ccx Shift vs. Case Temperature**

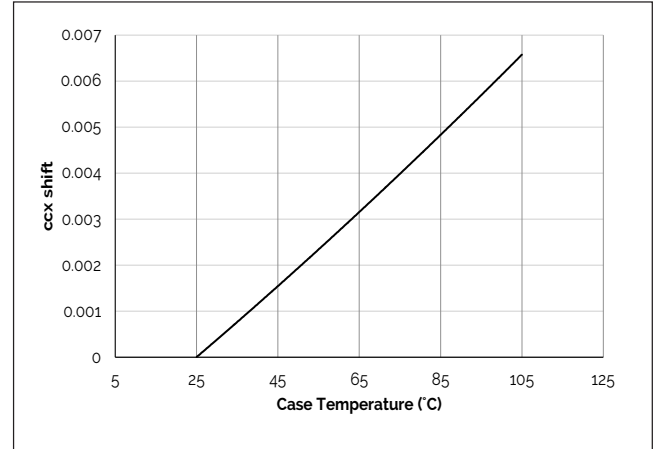

**Figure 9: Typical DC ccy Shift vs. Case Temperature**

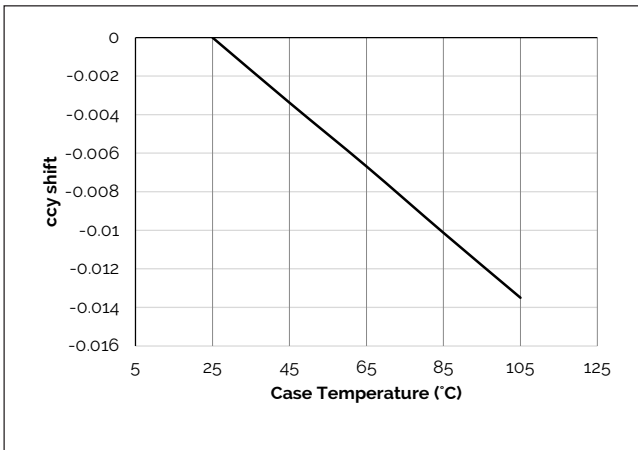

**Figure 10: V22B Drive Current vs. ccx Shift**

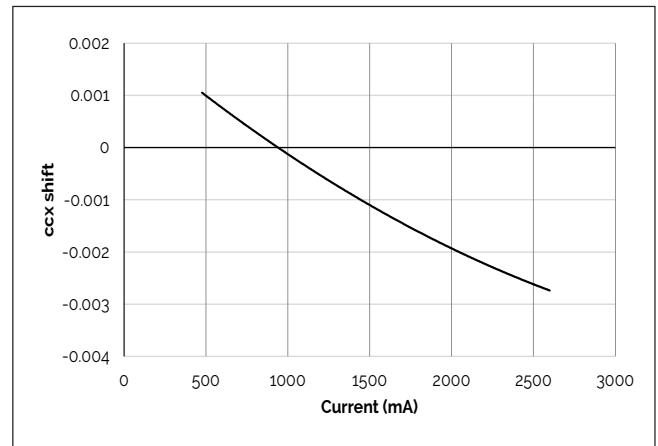

**Figure 11: V22B Drive Current vs. ccy Shift**

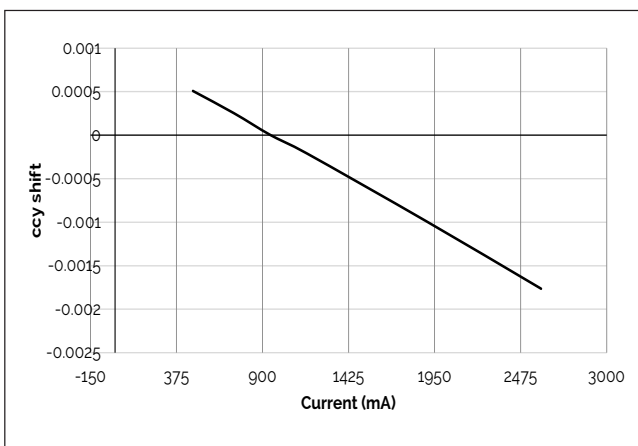

**Figure 12: V22C Drive Current vs. ccx Shift**

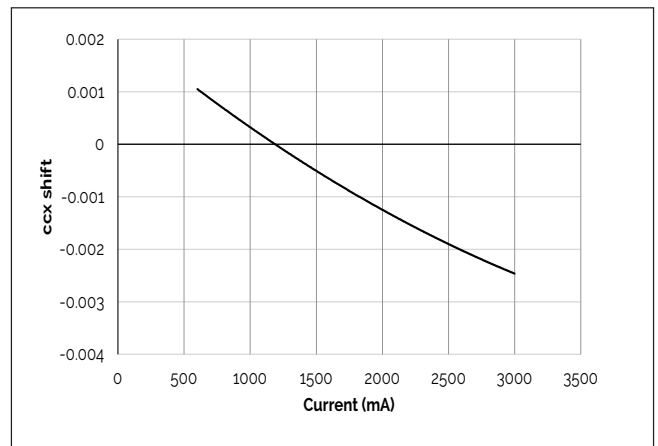

Note for Figures 7-12:

1. Characteristics shown for Warm White.

# Performance Curves

**Figure 13: V22C Drive Current vs. ccy Shift**

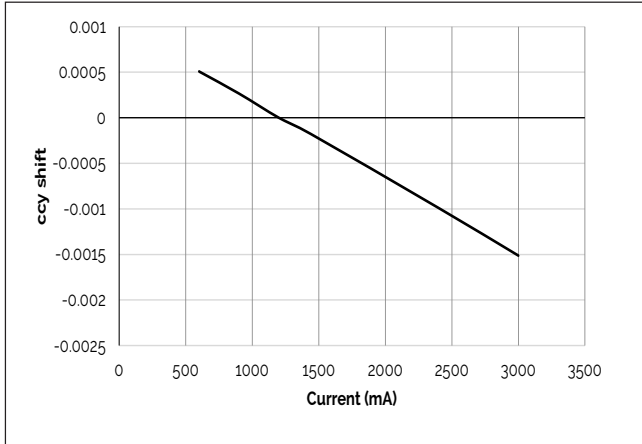

**Figure 14: V22D Drive Current vs. ccx Shift**

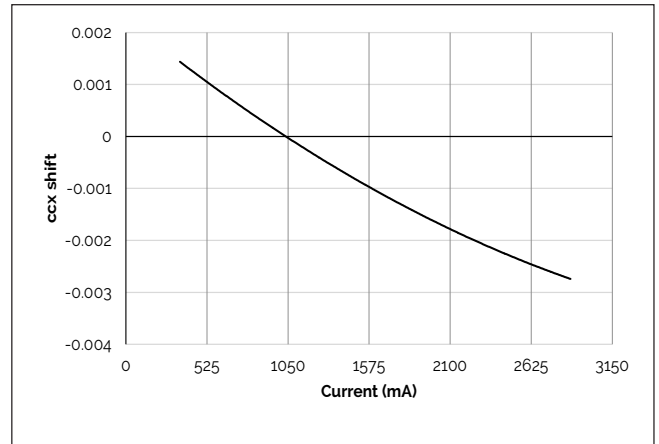

**Figure 15: V22D Drive Current vs. ccy Shift**

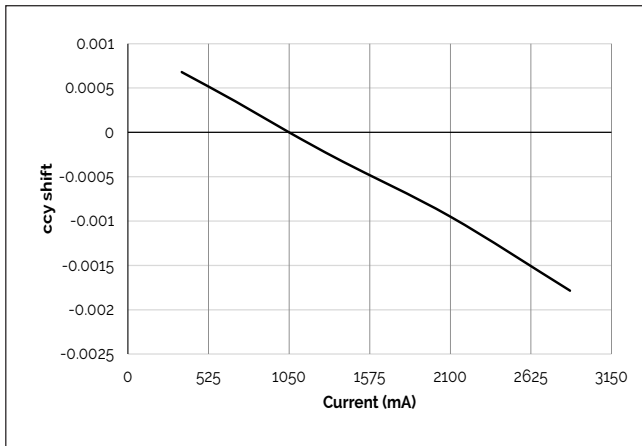

**Figure 16: Derating Curve**

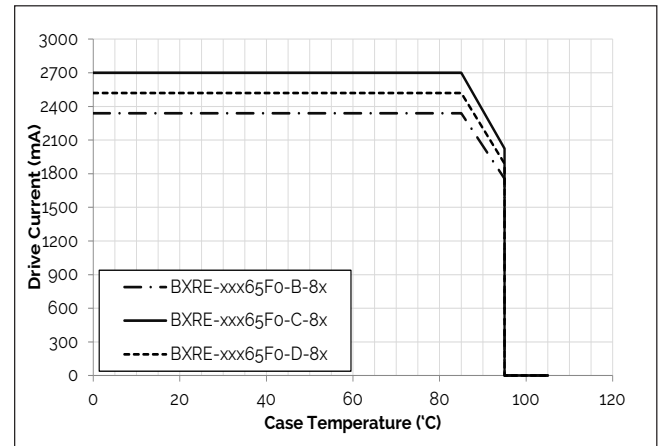

Note for Figures 13-15:

1. Characteristics shown for Warm White.



# Typical Radiation Pattern

Figure 17: Typical Spatial Radiation Pattern

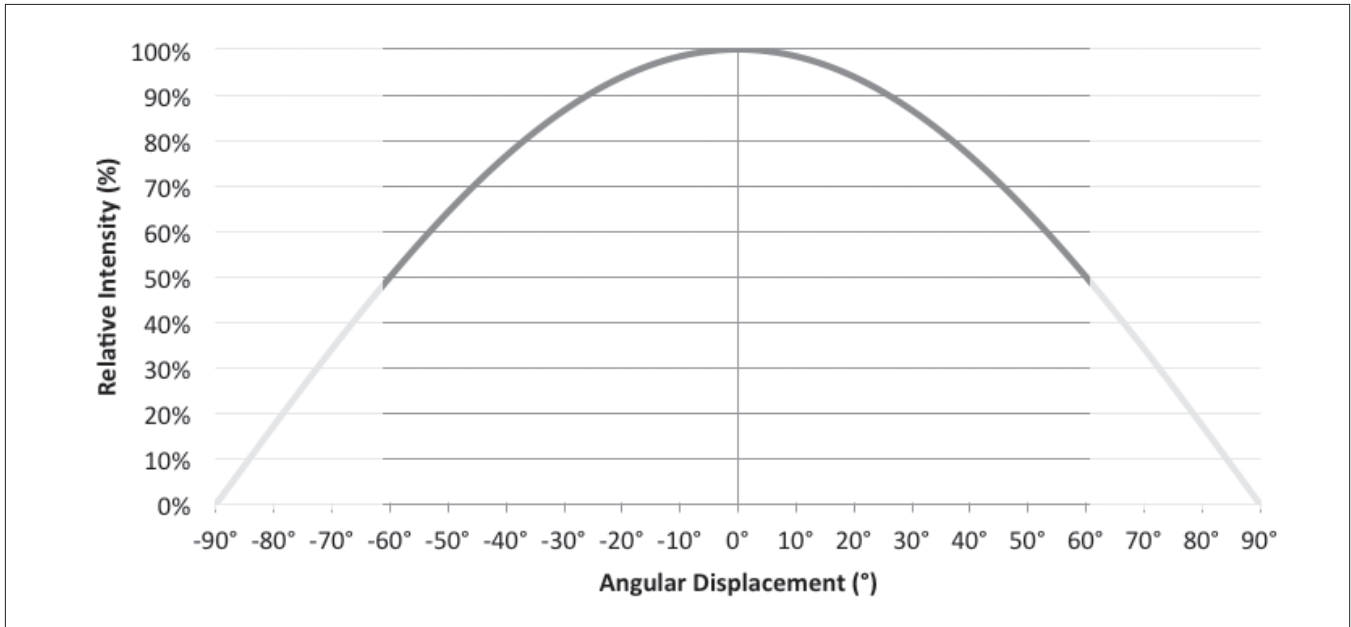

Notes for Figure 17:

1. Typical viewing angle is 120°.
2. The viewing angle is defined as the off axis angle from the centerline where intensity is ½ of the peak value.

Figure 18: Typical Polar Radiation Pattern

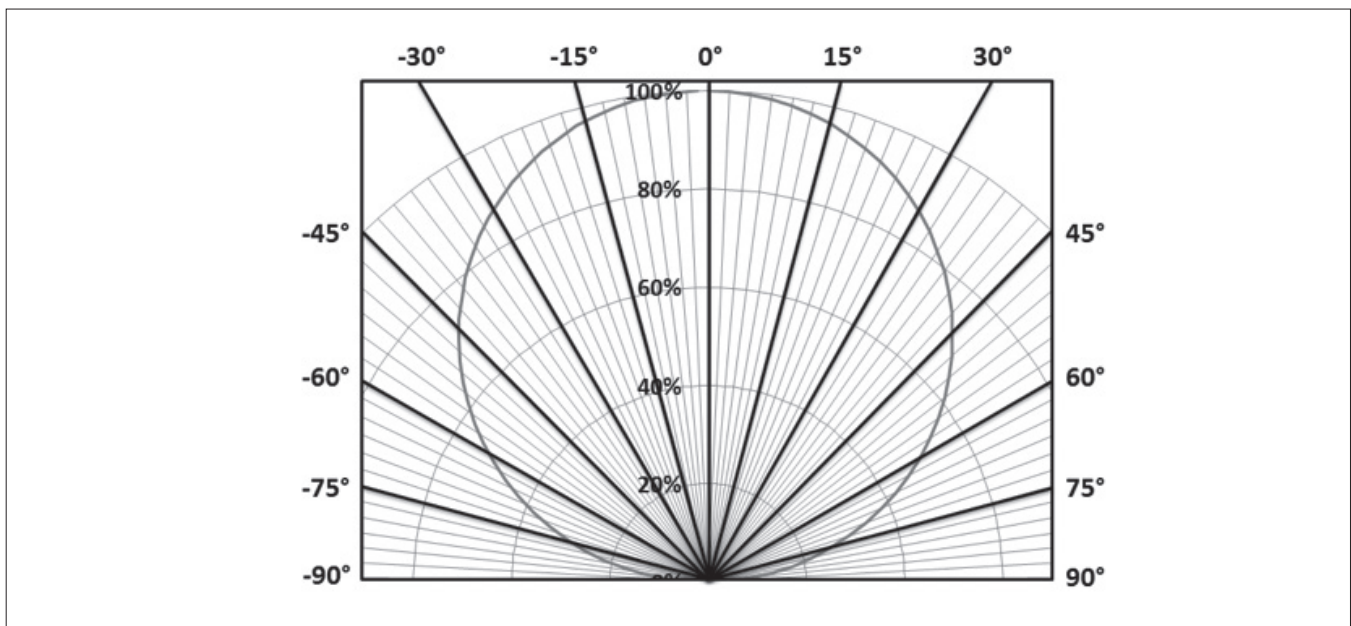

# Typical Color Spectrum

Figure 19: Typical Color Spectrum

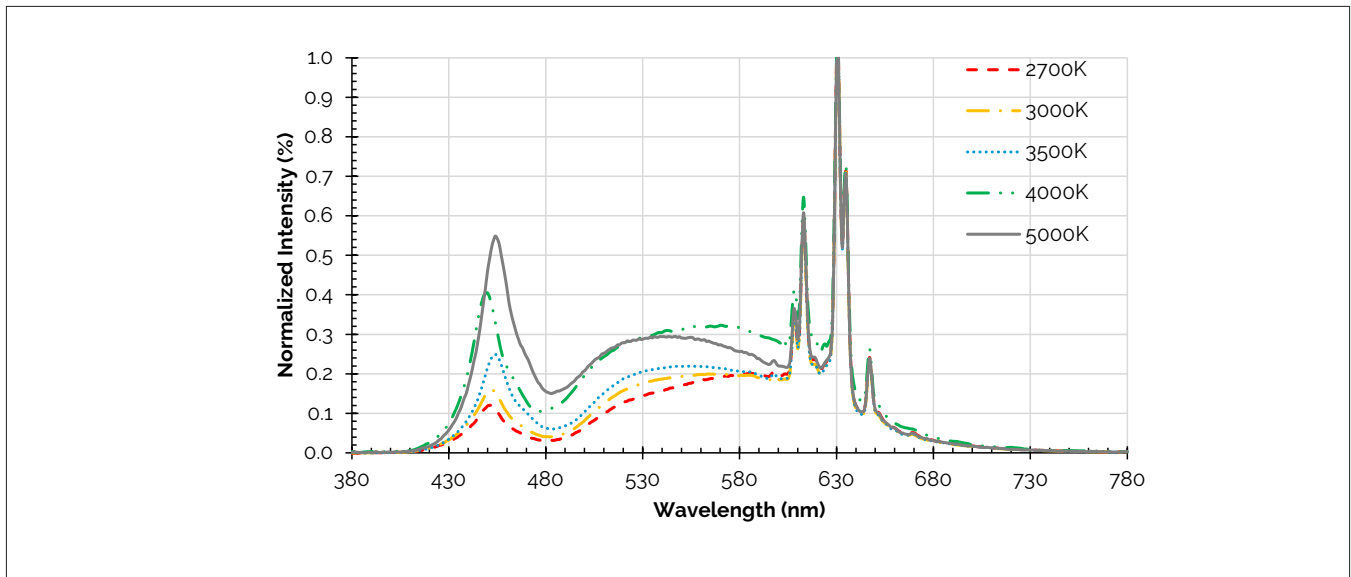

Notes for Figure 19:

1. Color spectra measured at nominal current for  $T_j = T_c = 85^\circ\text{C}$ .
2. Color spectra shown is 2700K and 90CRI.
3. Color spectra shown is 3000K and 90 CRI.
4. Color spectra shown is 3500K and 90 CRI.
5. Color spectra shown is 4000K and 90 CRI.
6. Color spectra shown is 5000K and 90 CRI.

# Mechanical Dimensions

Figure 20: V22 LED Array

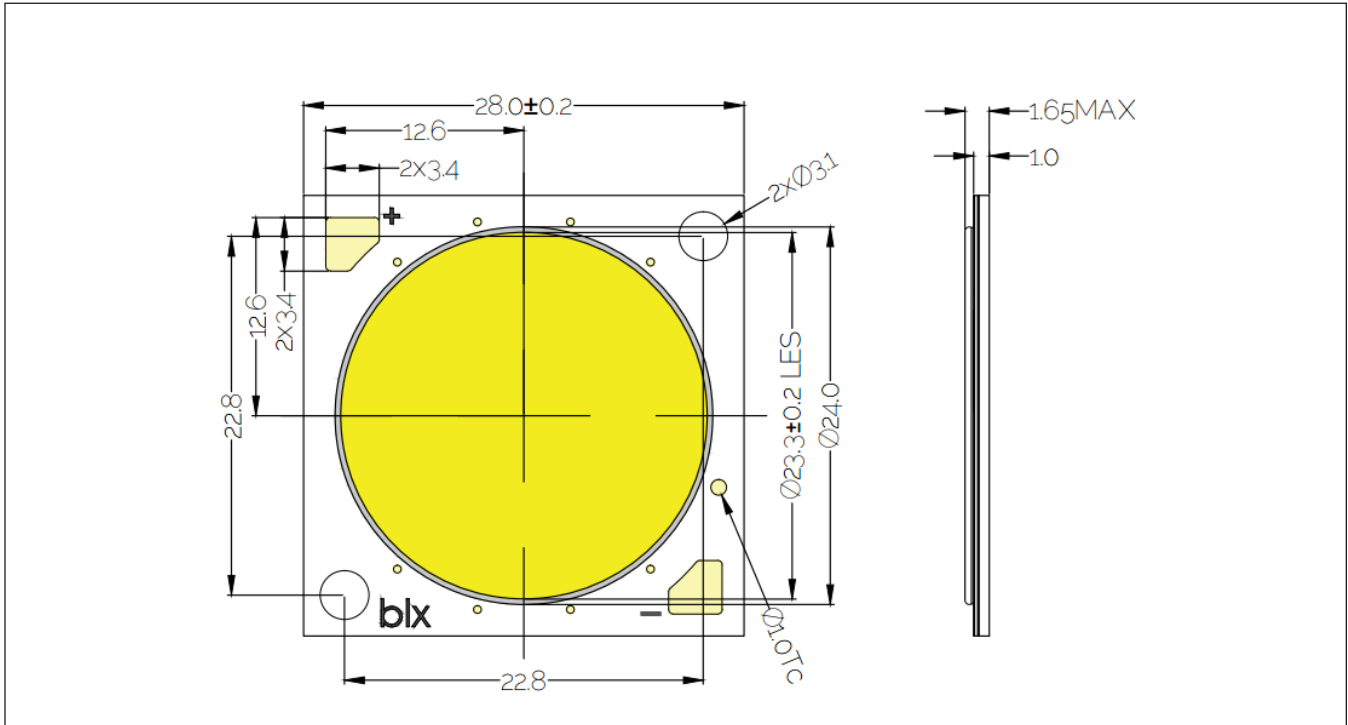

Notes for Figure 20:

1. Drawings are not to scale.
2. Drawing dimensions are in millimeters.
3. Unless otherwise specified, tolerances are ±0.1mm.
4. Solder pad labeled "+" denotes positive contact.
5. Refer to Application Notes AN101 for product handling, mounting and heat sink recommendations.
6. The optical center of the LED Array is nominally defined by the mechanical center of the array to a tolerance of ± 0.2mm.
7. Bridgelux maintains a flatness of 0.10mm across the mounting surface of the array.

# Color Binning Information

**Figure 21: Warm and Neutral White Test Bins in xy Color Space**

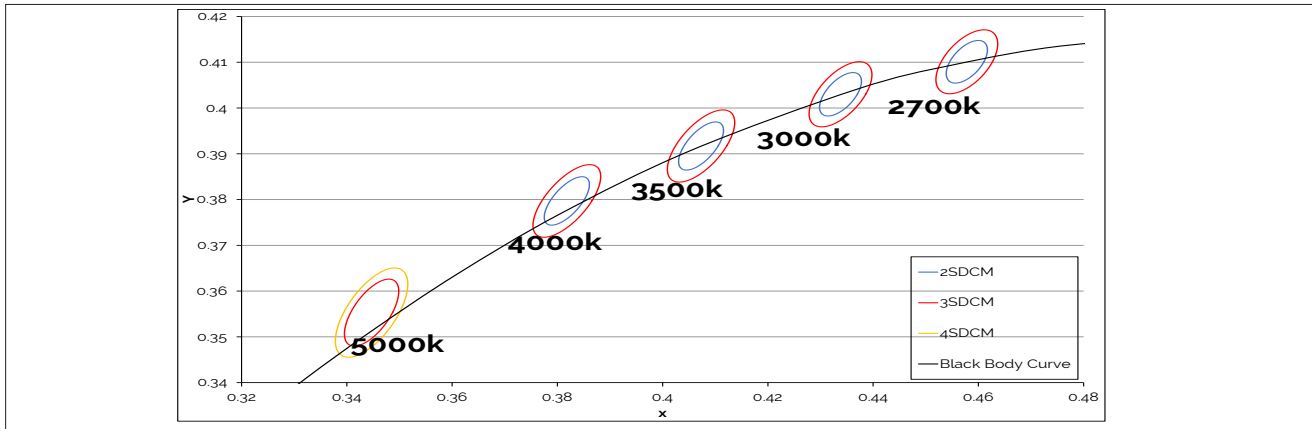

Note: Pulsed Test Conditions,  $T_c = 85^\circ\text{C}$

**Table 8: Warm and Neutral White xy Bin Coordinates and Associated Typical CCT (product is hot targeted to  $T_c = 85^\circ\text{C}$ )**

Bin Code	2700K	3000K	3500K	4000K
ANSI Bin (for reference only)	(2580K - 2870K)	(2870K - 3220K)	(3220K - 3710K)	(3710K - 4260K)
83 (3 SDCM)	(2651K - 2794K)	(2968K - 3136K)	(3369K - 3586K)	(3851K - 4130K)
82 (2 SDCM)	(2674K - 2769K)	(2995K - 3107K)	(3404K - 3548K)	(3895K - 4081K)
Center Point (x,y)	(0.4578, 0.4101)	(0.4338, 0.403)	(0.4073, 0.3917)	(0.3818, 0.3797)

**Table 9: Cool White xy Bin Coordinates and Associated Typical CCT (product is hot targeted to  $T_c = 85^\circ\text{C}$ )**

Bin Code	5000K
ANSI Bin (for reference only)	(4745K - 5311K)
84 (4 SDCM)	(4801K - 5282K)
83 (3 SDCM)	(4835K - 5215K)
Center Point (x,y)	(0.3447, 0.3553)

Note for Tables 8-g:

1. Bridgelux maintains a tolerance of +/- 0.007 on x and y color coordinates in the CIE 1931 color Space.

# Packaging and Labeling

Figure 22: V22 Packaging Tube



Notes for Figure 22:

1. Each tube holds 15 V22 COB arrays.
2. Four tubes are sealed in an anti-static bag. Four bags are placed in a shipping box and shipped. Depending on quantities ordered, a bigger shipping box, containing four boxes may be used to ship products.
3. Each bag and box is to be labeled as shown above.
4. Dimensions for each tube are 30.7 (W) x 9.65(H) x 460(L). Dimensions for the anti-static bag are 120mm (W) x 635mm (L) x 0.1 (T) mm. Dimensions for the shipping box are 58.7 x 13.3 x 7.9 cm.

# Packaging and Labeling

**Figure 23: Product Labeling**

Bridgelux COB arrays have laser markings on the back side of the substrate to help with product identification. In addition to the product identification markings, Bridgelux COB arrays also contain markings for internal Bridgelux manufacturing use only. The image below shows which markings are for customer use and which ones are for Bridgelux internal use only. The Bridgelux internal manufacturing markings are subject to change without notice, however these will not impact the form, function or performance of the COB array.

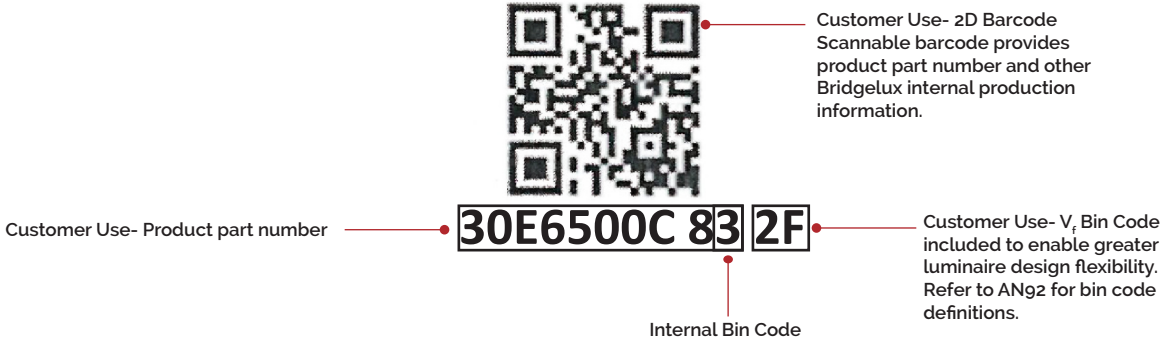

# Design Resources

## Application Notes

Bridgelux has developed a comprehensive set of application notes and design resources to assist customers in successfully designing with the V Series product family of LED array products. For all available application notes visit [www.bridgelux.com](http://www.bridgelux.com).

## Optical Source Models

Optical source models and ray set files are available for all Bridgelux products. For a list of available formats, visit [www.bridgelux.com](http://www.bridgelux.com).

## 3D CAD Models

Three dimensional CAD models depicting the product outline of all Bridgelux V Series LED arrays are available in both IGS and STEP formats. Please contact your Bridgelux sales representative for assistance.

## LM80

LM80 testing has been completed and the LM80 report is now available. Please contact your Bridgelux sales representative for LM-80 report.

# Precautions

## CAUTION: CHEMICAL EXPOSURE HAZARD

Exposure to some chemicals commonly used in luminaire manufacturing and assembly can cause damage to the LED array. Please consult Bridgelux Application Note AN101 for additional information.

## CAUTION: RISK OF BURN

Do not touch the V Series LED array during operation. Allow the array to cool for a sufficient period of time before handling. The V Series LED array may reach elevated temperatures such that could burn skin when touched.

## CAUTION

### CONTACT WITH LIGHT EMITTING SURFACE (LES)

Avoid any contact with the LES. Do not touch the LES of the LED array or apply stress to the LES (yellow phosphor resin area). Contact may cause damage to the LED array.

Optics and reflectors must not be mounted in contact with the LES (yellow phosphor resin area).

# Disclaimers

## MINOR PRODUCT CHANGE POLICY

The rigorous qualification testing on products offered by Bridgelux provides performance assurance. Slight cosmetic changes that do not affect form, fit, or function may occur as Bridgelux continues product optimization.

## STANDARD TEST CONDITIONS

Unless otherwise stated, array testing is performed at the nominal drive current.

# About Bridgelux: Bridging Light and Life™

At Bridgelux, we help companies, industries and people experience the power and possibility of light. Since 2002, we've designed LED solutions that are high performing, energy efficient, cost effective and easy to integrate. Our focus is on light's impact on human behavior, delivering products that create better environments, experiences and returns—both experiential and financial. And our patented technology drives new platforms for commercial and industrial luminaires.

**For more information about the company, please visit**  
**[bridgelux.com](http://bridgelux.com)**  
**[twitter.com/Bridgelux](https://twitter.com/Bridgelux)**  
**[facebook.com/Bridgelux](https://facebook.com/Bridgelux)**  
**[youtube.com/user/Bridgelux](https://youtube.com/user/Bridgelux)**  
**[linkedin.com/company/bridgelux-inc-\\_2](https://linkedin.com/company/bridgelux-inc-_2)**  
**WeChat ID: BridgeluxInChina**



46410 Fremont Boulevard  
Fremont, CA 94538 U.S.A.  
Tel (925) 583-8400  
**[www.bridgelux.com](http://www.bridgelux.com)**

© 2022 Bridgelux, Inc. All rights reserved. Product specifications are subject to change without notice. Bridgelux, the Bridgelux stylized logo design and Vero are registered trademarks. V Series and Decor Series are trademarks of Bridgelux, Inc. All other trademarks are the property of their respective owners.

**Bridgelux V22 F90 Array Series Product Data Sheet DS449 Rev. A (03/2022)**



## X-ON Electronics

Largest Supplier of Electrical and Electronic Components

*Click to view similar products for [High Power LEDs - White category:](#)*

*Click to view products by [Bridgelux manufacturer:](#)*

Other Similar products are found below :

[LTW-K140SZR40](#) [B42180-08](#) [STW8Q2PA-R5-HA](#) [LTPL-P00DWS57](#) [LTW-K140SZR30](#) [LZP-D0WW00-0000](#) [SZ5-M1-WW-C8-V1/V3-FA](#) [LTW-K140SZR57](#) [LTW-K140SZR27](#) [BXRE-50C2001-C-74](#) [MP-5050-8100-27-80](#) [MP-5050-6100-65-80](#) [MP-5050-6100-40-80](#) [MP-5050-6100-30-80](#) [KW DPLS32.SB-6H6J-E5P7-EG-Z264](#) [L1V1-507003V500000](#) [KW CULPM1.TG-Z6RF7-ebvFfcbB46-65G5](#) [KW DMLS33.SG-Z6M7-EBVFFCBB46-8E8G-700-S](#) [KW DPLS33.KD-HIJG-D30D144-HN-22C2-120-S](#) [KW DDLM31.EH-5J6K-A737-W4A4-140-R18](#) [GW JTLRS1.CM-K1LW-XX57-1-100-Q-R33](#) [KW DDLM31.EH-5J6K-A636-W4A4-140-R18](#) [KW DDLM31.EH-5J6K-A131-W4A4-140-R18](#) [SML-LXL8047MWCTR/3](#) [L2C5-40HG1203E0900](#) [JB3030AWT-P-U27EA0000-N0000001](#) [JK3030AWT-P-U30EA0000-N0000001](#) [JK3030AWT-P-B40EB0000-N0000001](#) [JK3030AWT-P-H30EB0000-N0000001](#) [JK3030AWT-P-H40EB0000-N0000001](#) [JK3030AWT-P-U27EB0000-N0000001](#) [JK3030AWT-P-U30EB0000-N0000001](#) [GW PUSTA1.PM-PAPC-XX53-1-1050-R18](#) [BXRE-30E4000-C-83](#) [BXRE-50C6501-D-84](#) [BXRE-27E1000-B-83](#) [BXRE-30G0800-D-83](#) [BXRE-50C4001-B-84](#) [BXRE-50C6501-C-84](#) [BXRH-40E4000-F-83](#) [BXRH-27G4000-F-83](#) [BXRE-27G30H0-D-82](#) [BXRE-27G4000-B-83](#) [BXRE-40E1000-B-83](#) [BXRE-40E6500-D-83](#) [BXRH-27E1000-B-83](#) [BXRH-27E1000-G-83](#) [BXRH-27E4000-F-83](#) [BXRH-27G1000-B-83](#) [BXRH-30E0600-A-83](#)