

Bridgelux® Gen 7 V10 Thrive™ Array

Product Data Sheet DS320



BXRE-27S | 30S | 35S | 40S | 50S | 57S | 65S

Introduction

V10 Thrive



Bridgelux Thrive™ combines unique chip, phosphor and packaging technology to closely match the spectra of natural light over the visible wavelength range. Thrive can be used in constant color point luminaires to bring full spectrum natural light indoors or in tunable white luminaires to incorporate circadian elements that may impact human well-being. The high fidelity spectral output of Thrive creates stunning environments with excellent color rendering and outstanding TM30 metrics. Thrive is available in both SMD components and LED arrays to enable a broad range of lighting applications including retail, hospitality, office, education, architectural, museums, healthcare and residential lighting.

Features

- Engineered spectrum to closely match natural light
- CRI >95, R1-R15 >90, high Rf and Rg values
- High efficacy full spectrum solution
- No violet chip augmentation
- Hot color targeted
- Form factor consistent with existing Bridgelux COB arrays
- Broad product platform availability (SMDs and COBs)

Benefits

- Full consistent spectrum with fewer spectral spikes
- Natural and vivid color rendering
- Greater energy savings, lower utility costs
- Economical, high efficiency solution
- Uniform and consistent white light at application conditions
- Ease of design and rapid go-to-market
- Enables greater design flexibility and platform color consistency



Contents

Product Feature Map	2
Product Nomenclature	2
Product Selection Guide	3
Spectrum Characteristics	6
Electrical Characteristics	9
Absolute Maximum Ratings	10
Eye Safety	11
Product Bin Definitions	12
Performance Curves	13
Typical Radiation Pattern	15
Mechanical Dimensions	16
Packaging and Labeling	17
Design Resources	19
Precautions	19
Disclaimers	19
About Bridgelux	20

Product Feature Map

Bridgelux arrays are fully engineered devices that provide consistent thermal and optical performance on an engineered mechanical platform. The V Series arrays are the most compact chip-on-board devices across all of Bridgelux's LED Array products. The arrays incorporate several features to simplify design integration and assembly. Please visit www.bridgelux.com for more information on the V Series family of products.

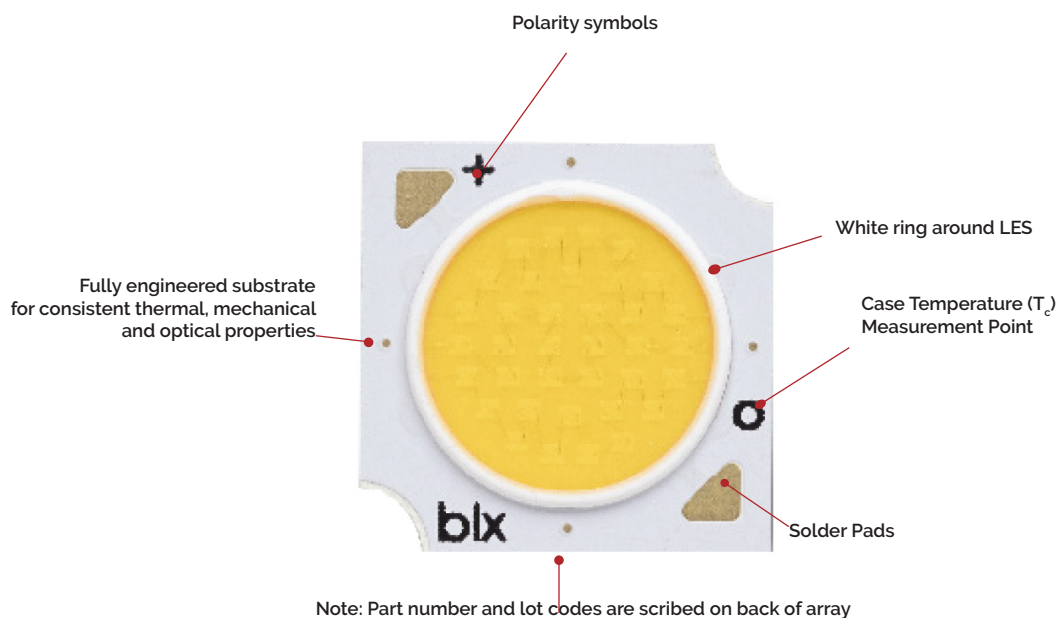

Product Nomenclature

The part number designation for Bridgelux COB arrays is explained as follows:

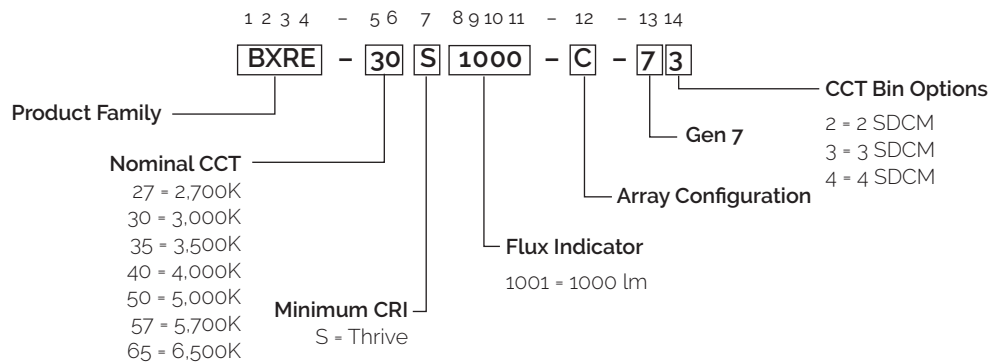

Product Selection Guide

The following product configurations are available:

Table 1: Selection Guide, Pulsed Measurement Data ($T_c = 25^\circ\text{C}$)

Part Number ^{1,6}	Nominal CCT ¹ (K)	CRI ²	Nominal Drive Current ³ (mA)	Typical V_f (V)	Typical Pulsed Flux ^{4,5,6,7} $T_c = 25^\circ\text{C}$ (lm)	Minimum Pulsed Flux ^{6,7,8} $T_c = 25^\circ\text{C}$ (lm)	Typical Power (W)	Typical Efficacy (lm/W)	Typical Photosynthetic Photon Flux (PPF)	Typical Photon Efficiency ($\mu\text{mol/J}$)
BXRE-27S1001-B-7x	2700	95	270	34.4	1003	883	9.3	108	17.50	1.90
BXRE-27S1001-C-7x	2700	95	360	34.4	1337	1177	12.4	108	23.33	1.90
BXRE-30S1001-B-7x	3000	95	270	34.4	1077	948	9.3	116	18.40	1.99
BXRE-30S1001-C-7x	3000	95	360	34.4	1437	1264	12.4	116	24.55	1.99
BXRE-35S1001-B-7x	3500	95	270	34.4	1124	989	9.3	121	18.60	1.99
BXRE-35S1001-C-7x	3500	95	360	34.4	1498	1319	12.4	121	24.79	1.99
BXRE-40S1001-B-7x	4000	95	270	34.4	1142	1005	9.3	123	18.59	1.97
BXRE-40S1001-C-7x	4000	95	360	34.4	1523	1340	12.4	123	24.79	1.97
BXRE-50S1001-B-74	5000	95	270	34.4	1198	1054	9.3	129	19.64	2.06
BXRE-50S1001-C-74	5000	95	360	34.4	1598	1406	12.4	129	26.19	2.06
BXRE-57S1001-B-74	5700	95	270	34.4	1226	1079	9.3	132	20.16	2.10
BXRE-57S1001-C-74	5700	95	360	34.4	1635	1439	12.4	132	26.88	2.10
BXRE-65S1001-B-74	6500	95	270	34.4	1207	1063	9.3	130	19.85	2.07
BXRE-65S1001-C-74	6500	95	360	34.4	1610	1417	12.4	130	26.47	2.07

Table 2: Selection Guide, Stabilized DC Test Performance ($T_c = 85^\circ\text{C}$)^{4,5,6}

Part Number ^{1,6}	Nominal CCT ¹ (K)	CRI ²	Nominal Drive Current ³ (mA)	Typical V_f (V)	Typical DC Flux ^{4,5,6,7} $T_c = 85^\circ\text{C}$ (lm)	Minimum DC Flux ^{6,7,8,9} $T_c = 85^\circ\text{C}$ (lm)	Typical Power (W)	Typical Efficacy (lm/W)	Typical Photosynthetic Photon Flux (PPF)	Typical Photon Efficiency ($\mu\text{mol/J}$)
BXRE-27S1001-B-7x	2700	95	270	33.7	903	794	9.1	99	15.76	1.90
BXRE-27S1001-C-7x	2700	95	360	33.7	1204	1059	12.1	99	21.01	1.90
BXRE-30S1001-B-7x	3000	95	270	33.7	970	853	9.1	107	16.57	1.99
BXRE-30S1001-C-7x	3000	95	360	33.7	1293	1138	12.1	107	22.09	1.99
BXRE-35S1001-B-7x	3500	95	270	33.7	1011	890	9.1	111	16.73	1.99
BXRE-35S1001-C-7x	3500	95	360	33.7	1349	1187	12.1	111	22.33	1.99
BXRE-40S1001-B-7x	4000	95	270	33.7	1028	905	9.1	113	16.73	1.97
BXRE-40S1001-C-7x	4000	95	360	33.7	1371	1206	12.1	113	22.31	1.97
BXRE-50S1001-B-74	5000	95	270	33.7	1078	949	9.1	119	17.67	2.06
BXRE-50S1001-C-74	5000	95	360	33.7	1438	1265	12.1	119	23.57	2.06
BXRE-57S1001-B-74	5700	95	270	33.7	1103	971	9.1	121	18.14	2.10
BXRE-57S1001-C-74	5700	95	360	33.7	1471	1295	12.1	121	24.19	2.10
BXRE-65S1001-B-74	6500	95	270	33.7	1087	956	9.1	119	17.87	2.07
BXRE-65S1001-C-74	6500	95	360	33.7	1449	1275	12.1	119	23.82	2.07

Notes for Table 1 & 2:

- Product CCT is hot targeted at $T_j = 85^\circ\text{C}$. Nominal CCT as defined by ANSI C78.377-2011.
- All CRI values are measured at $T_j = T_c = 25^\circ\text{C}$. CRI values are minimums. Bridgelux maintains a ± 3 tolerance on CRI values.
- Drive current is referred to as nominal drive current.
- Products tested under pulsed condition (10ms pulse width) at nominal test current where T_j (junction temperature) - T_c (case temperature) = 25°C . Typical stabilized DC performance values are provided as reference only and are not a guarantee of performance.
- Typical performance values are provided as a reference only and are not a guarantee of performance.
- Typical performance is estimated based on operation under DC (direct current) with LED array mounted onto a heat sink with thermal interface material and the case temperature maintained at 85°C . Based on Bridgelux test setup, values may vary depending on the thermal design of the luminaire and/or the exposed environment to which the product is subjected.
- Bridgelux maintains a $\pm 7\%$ tolerance on flux measurements.
- Minimum flux values at the nominal test current are guaranteed by 100% test.
- Minimum flux values at elevated temperatures are provided for reference only and are not guaranteed by 100% production testing. Based on Bridgelux test setup, values may vary depending on the thermal design of the luminaire and/or the exposed environment to which the product is subjected.

Performance at Commonly Used Drive Currents

V Series Thrive LED arrays are tested to the specifications shown using the nominal drive currents in Table 1. V Series Thrive LED Arrays may also be driven at other drive currents dependent on specific application design requirements. The performance at any drive current can be derived from the current vs. voltage characteristics shown in Figures 10 & 11 and the flux vs. current characteristics shown in Figures 12 & 13. The performance at commonly used drive currents is summarized in Table 3.

Table 3: Product Performance at Commonly Used Drive Currents

Part Number	CRI	Drive Current ¹ (mA)	Typical V _f T _c = 25°C (V)	Typical Power T _c = 25°C (W)	Typical Flux ² T _c = 25°C (lm)	Typical DC Flux ³ T _c = 85°C (lm)	Typical Efficacy T _c = 25°C (lm/W)
BXRE-27S1001-B-7x	95	135	32.8	4.4	535	480	121
		180	33.6	6.1	701	629	116
		270	34.4	9.3	1003	903	108
		405	35.2	14.3	1472	1309	103
		540	35.7	19.3	1885	1669	98
BXRE-27S1001-C-7x	95	180	32.8	5.9	711	635	120
		240	33.6	8.1	932	828	115
		360	34.4	12.4	1337	1204	108
		540	35.2	19.0	1948	1692	102
		720	35.7	25.7	2488	2130	97
BXRE-30S1001-B-7x	95	135	32.8	4.4	574	516	130
		180	33.6	6.1	753	675	124
		270	34.4	9.3	1077	970	116
		405	35.2	14.3	1581	1406	111
		540	35.7	19.3	2025	1792	105
BXRE-30S1001-C-7x	95	180	32.8	5.9	764	682	129
		240	33.6	8.1	1001	889	124
		360	34.4	12.4	1437	1293	116
		540	35.2	19.0	2092	1817	110
		720	35.7	25.7	2672	2287	104
BXRE-35S1001-B-7x	95	135	32.8	4.4	599	538	135
		180	33.6	6.1	785	704	130
		270	34.4	9.3	1124	1011	121
		405	35.2	14.3	1649	1467	116
		540	35.7	19.3	2112	1870	109
BXRE-35S1001-C-7x	95	180	32.8	5.9	797	711	135
		240	33.6	8.1	1044	927	129
		360	34.4	12.4	1498	1349	121
		540	35.2	19.0	2182	1896	115
		720	35.7	25.7	2787	2386	108
BXRE-40S1001-B-7x	95	135	32.8	4.4	609	547	137
		180	33.6	6.1	798	716	132
		270	34.4	9.3	1142	1028	123
		405	35.2	14.3	1676	1491	117
		540	35.7	19.3	2147	1900	111
BXRE-40S1001-C-7x	95	180	32.8	5.9	810	723	137
		240	33.6	8.1	1061	943	132
		360	34.4	12.4	1523	1371	123
		540	35.2	19.0	2218	1927	117
		720	35.7	25.7	2833	2425	110

Notes for Table 3:

1. Alternate drive currents are provided for reference only and are not a guarantee of performance.
2. Bridgelux maintains a ± 7% tolerance on flux measurements.
3. Typical stabilized DC performance values are provided as reference only and are not a guarantee of performance.

Performance at Commonly Used Drive Currents

Table 3: Product Performance at Commonly Used Drive Currents (Continued)

Part Number	CRI	Drive Current ¹ (mA)	Typical V _f T _c = 25°C (V)	Typical Power T _c = 25°C (W)	Typical Flux ² T _c = 25°C (lm)	Typical DC Flux ³ T _c = 85°C (lm)	Typical Efficacy T _c = 25°C (lm/W)
BXRE-50S1001-B-74	95	135	32.8	4.4	638	574	144
		180	33.6	6.1	837	751	138
		270	34.4	9.3	1198	1078	129
		405	35.2	14.3	1758	1564	123
		540	35.7	19.3	2252	1993	117
BXRE-50S1001-C-74	95	180	32.8	5.9	849	758	144
		240	33.6	8.1	1113	989	138
		360	34.4	12.4	1598	1438	129
		540	35.2	19.0	2326	2021	122
		720	35.7	25.7	2972	2544	116
BXRE-57S1001-B-74	95	135	32.8	4.4	653	587	147
		180	33.6	6.1	857	768	142
		270	34.4	9.3	1226	1103	132
		405	35.2	14.3	1799	1600	126
		540	35.7	19.3	2304	2039	119
BXRE-57S1001-C-74	95	180	32.8	5.9	869	776	147
		240	33.6	8.1	1139	1012	141
		360	34.4	12.4	1635	1471	132
		540	35.2	19.0	2380	2068	125
		720	35.7	25.7	3041	2603	118
BXRE-65S1001-B-74	95	135	32.8	4.4	643	578	145
		180	33.6	6.1	844	757	139
		270	34.4	9.3	1207	1087	130
		405	35.2	14.3	1771	1576	124
		540	35.7	19.3	2269	2009	118
BXRE-65S1001-C-74	95	180	32.8	5.9	856	764	145
		240	33.6	8.1	1121	996	139
		360	34.4	12.4	1610	1449	130
		540	35.2	19.0	2344	2037	123
		720	35.7	25.7	2995	2563	116

Notes for Table 3:

1. Alternate drive currents are provided for reference only and are not a guarantee of performance.
2. Bridgelux maintains a ± 7% tolerance on flux measurements.
3. Typical stabilized DC performance values are provided as reference only and are not a guarantee of performance.

Spectrum Characteristics

Table 4: Typical Color Rendering Index and TM-30 Values at, $T_c=85^\circ\text{C}$

Nominal CCT ¹	R _f	R _g	R ₁	R ₂	R ₃	R ₄	R ₅	R ₆	R ₇	R ₈	R ₉	R ₁₀	R ₁₁	R ₁₂	R ₁₃	R ₁₄	R ₁₅
2700K	95	103	97	99	94	94	97	98	97	98	99	97	91	98	98	95	98
3000K	95	104	98	99	93	94	97	98	96	96	97	96	92	95	98	95	97
3500K	95	98	98	98	97	98	98	98	98	97	93	97	97	95	98	97	98
4000K	97	100	99	99	97	99	99	99	99	98	94	97	99	96	99	98	98
5000K	97	100	98	99	98	98	98	98	99	98	95	98	98	98	98	98	97
5700K	94	98	98	98	97	95	98	97	96	95	92	97	96	96	98	98	97
6500K	95	98	98	98	97	96	98	98	96	96	93	97	96	97	98	98	97

Note for Table 4:

1. Bridgelux maintains a tolerance of ± 3 on Color Rendering Index R1-R15 measurements and TM-30 measurements.

Figure 1: 2700K Thrive TM-30 Graphs

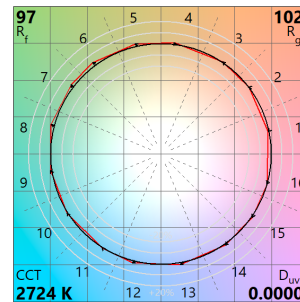
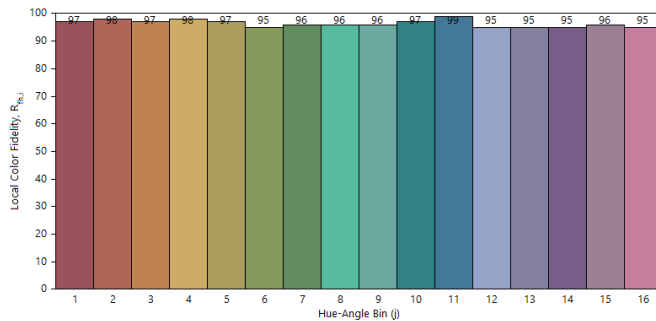

Figure 2: 3000K Thrive TM-30 Graphs

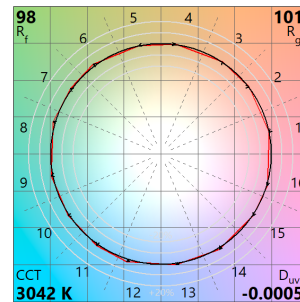
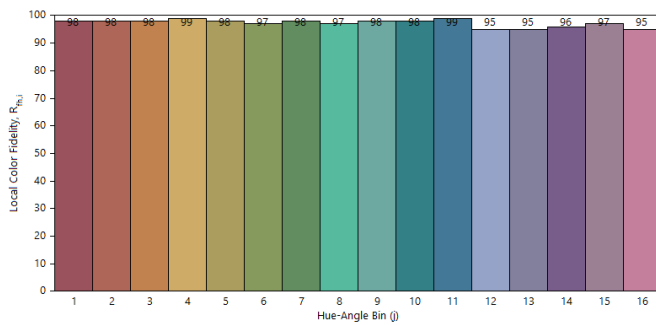
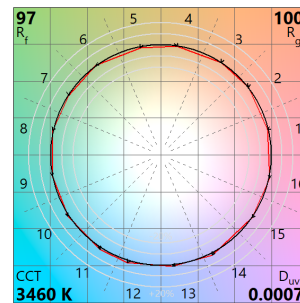
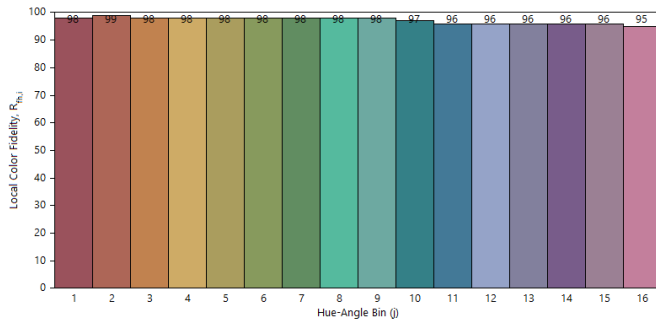

Figure 3: 3500K Thrive TM-30 Graphs



Spectrum Characteristics

Figure 4: 4000K Thrive TM-30 Graphs

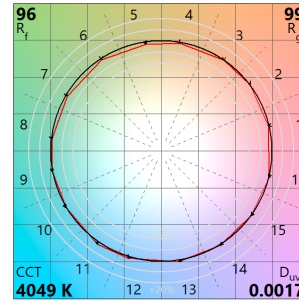
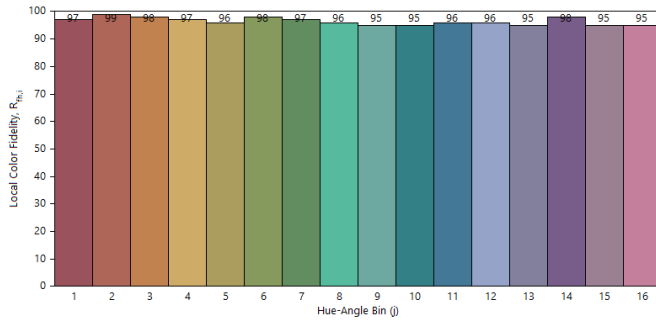

Figure 5: 5000K Thrive TM-30 Graphs

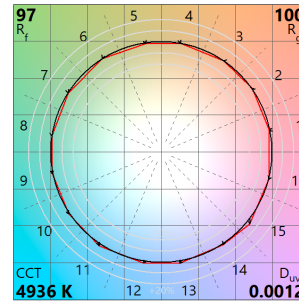
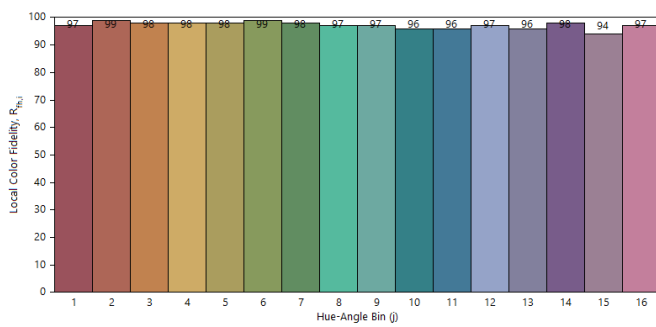

Figure 6: 5700K Thrive TM30 Graphs

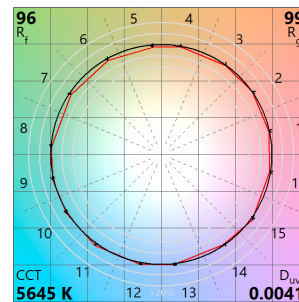
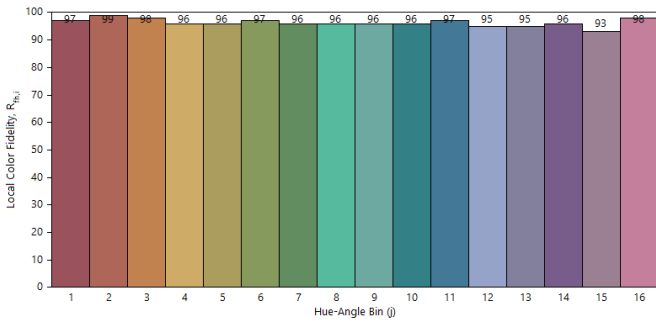
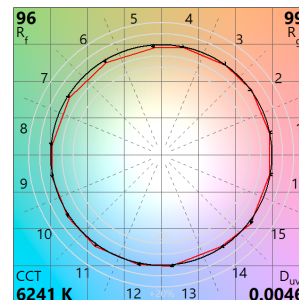
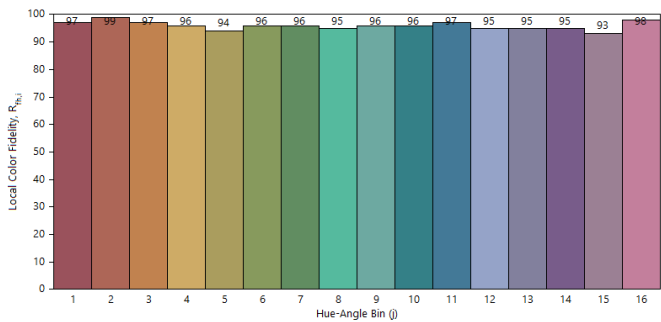
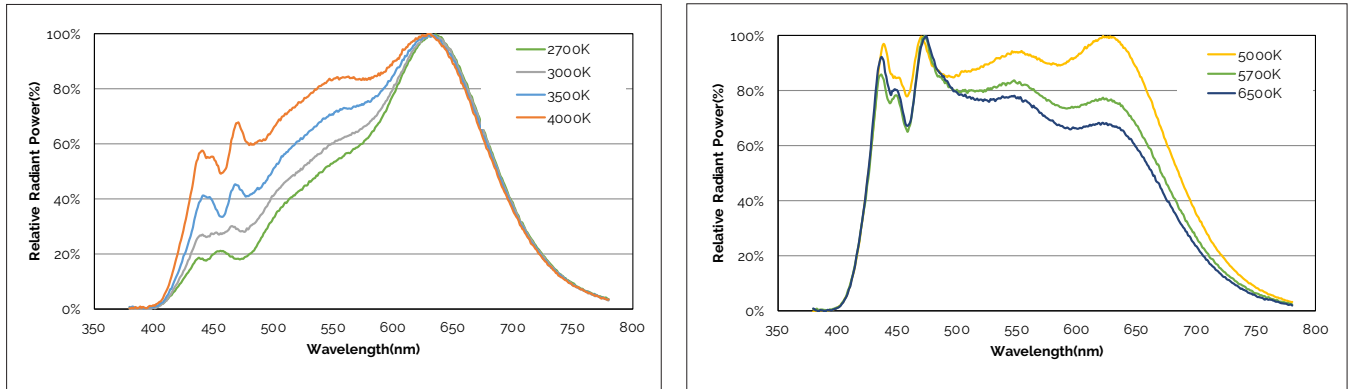

Figure 7: 6500K Thrive TM-30 Graphs



Spectrum Characteristics

Figure 8: Typical Color Spectrum



Note for Figure 8:

1. Color spectra measured at nominal current for $T_j = 85^\circ\text{C}$.

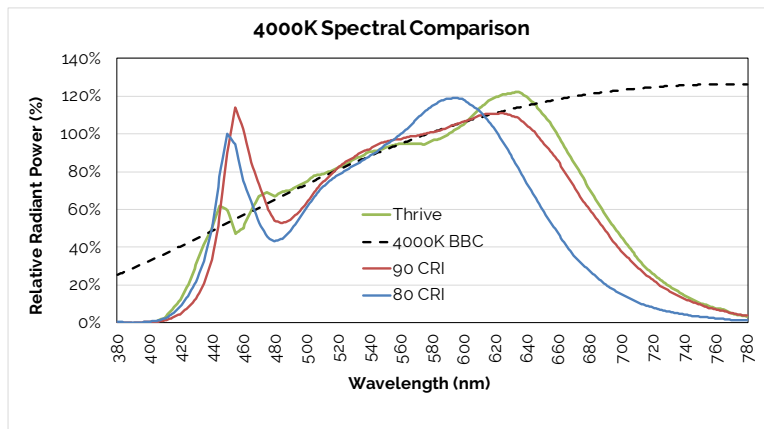

Spectral Matching to Natural Light

Humans have evolved and thrived for millions of years under the sun's natural daylight. While discussions continue regarding the development of LED products with artificial spectra aimed at increasing productivity and focus or helping with relaxation, the long-term physiological effects of such altered environments on humans remains unknown.

Bridgelux Thrive is engineered to provide the closest match to natural light using proprietary chip, phosphor and packaging technology. Bridgelux is working with our customers and industry partners to define new metrics to describe and quantify this spectral matching; going beyond today's quality of light metrics such as CRI and TM-30.

To quantify spectral matching, Bridgelux has defined a new term: Average Spectral Difference (ASD). ASD is calculated by measuring the absolute difference between the LED spectrum and a natural light source spectrum at discrete wavelengths. These values are then averaged across different wavelength ranges and reported as a percentage. Natural light is defined by the Black Body Curve for sources below 5000K or by the CIE Standard Illuminant D for sources of 5000K or above (D50 for example).

Bridgelux Thrive has an ASD between 3% and 7% for all color points (2700K – 6500K) across the typical LED wavelength range of 440-650nm. This includes a very close spectral match, with an ASD of only 2% for some color point options, in the blue/cyan color range where most other LED light sources suffer. For comparison purposes, standard 80, 90 and 98 CRI light sources have an ASD that is 2-6 times larger than Thrive over the same wavelength range and up to 20 times greater in the cyan wavelength range.

As the industry evolves toward human centric lighting, Bridgelux will work with our customers and industry experts to educate the market about the benefits of the ASD metric to further quantify the quality of light.

Electrical Characteristics

Table 5: Electrical Characteristics

Part Number	Drive Current (mA)	Forward Voltage Pulsed, $T_c = 25^\circ\text{C}$ (V) ^{1, 2, 3, 8}			Typical Coefficient of Forward Voltage ⁴ $\Delta V_f / \Delta T_c$ (mV/ $^\circ\text{C}$)	Typical Thermal Resistance Junction to Case ^{5,6} R_{j-c} ($^\circ\text{C}/\text{W}$)	Driver Selection Voltages ⁷ (V)	
		Minimum	Typical	Maximum			V_f Min. Hot $T_c = 105^\circ\text{C}$ (V)	V_f Max. Cold $T_c = -40^\circ\text{C}$ (V)
BXRE-xxx1001-B-7x	270	32.2	34.4	37.4	-16.1	0.49	30.9	38.5
	540	33.4	35.7	38.8	-16.1	0.56	32.1	39.9
BXRE-xxx1001-C-7x	360	32.2	34.4	37.4	-16.1	0.37	30.9	38.5
	720	33.4	35.7	38.8	-16.1	0.45	32.1	39.9

Notes for Table 5:

1. Parts are tested in pulsed conditions. $T_c = 25^\circ\text{C}$. Pulse width is 10ms.
2. Voltage minimum and maximum are provided for reference only and are not a guarantee of performance.
3. Bridgelux maintains a tester tolerance of $\pm 0.10\text{V}$ on forward voltage measurements.
4. Typical coefficient of forward voltage tolerance is $\pm 0.1\text{mV}$ for nominal current.
5. Thermal resistance values are based from test data of a 3000K 80 CRI product.
6. Thermal resistance value was calculated using total electrical input power; optical power was not subtracted from input power. The thermal interface material used during testing is not included in the thermal resistance value.
7. V_f min hot and max cold values are provided as reference only and are not guaranteed by test. These values are provided to aid in driver design and selection over the operating range of the product.
8. This product has been designed and manufactured per IEC 62031:2014. This product has passed dielectric withstand voltage testing at 1160 V. The working voltage designated for the insulation is 80V d.c. The maximum allowable voltage across the array must be determined in the end product application.

Absolute Maximum Ratings

Table 6: Maximum Ratings

Parameter	Maximum Rating	
LED Junction Temperature (T _j)	150°C	
Storage Temperature	-40°C to +105°C	
Operating Case Temperature ¹ (T _c)	105°C	
Soldering Temperature ²	300°C or lower for a maximum of 6 seconds	
	BXRE-xxx1001-B-7x	BXRE-xxx1001-C-7x
Maximum Drive Current ³	540mA	720mA
Maximum Peak Pulsed Drive Current ⁴	770mA	1030mA
Maximum Reverse Voltage ⁵	-60V	-60V

Notes for Table 6:

1. For IEC 62717 requirement, please consult your Bridgelux sales representative.
2. Refer to Bridgelux Application Note AN101: Handling and Assembly of Bridgelux V Series LED Arrays.
3. Arrays may be driven at higher currents however lumen maintenance may be reduced.
4. Bridgelux recommends a maximum duty cycle of 10% and pulse width of 20 ms when operating LED Arrays at maximum peak pulsed current specified. Maximum peak pulsed currents indicate values where LED Arrays can be driven without catastrophic failures.
5. Light emitting diodes are not designed to be driven in reverse voltage and will not produce light under this condition. Maximum rating provided for reference only.

Eye Safety

Table 7: Eye Safety Risk Group (RG) Classifications

Part Number	Drive Current ⁵ (mA)	CCT ^{1,5}			
		2700K/3000K	4000K ²	5000K ³	6500K ⁴
BXRE-xxx100x-B-7x	270	RG1	RG1	RG1	RG1
	405	RG1	RG1	RG1	RG2
	540	RG1	RG1	RG2	RG2
BXRE-xxx100x-C-7x	360	RG1	RG1	RG1	RG2
	540	RG1	RG1	RG2	RG2
	720	RG1	RG2	RG2	RG2

Notes for Table 7:

1. Eye safety classification for the use of Bridgelux V Series LED arrays is in accordance with specification IEC/TR 62778: Application of IEC 62471 for the assessment of blue light hazard to light sources and luminaires.
2. For products classified as RG2 at 4000K, $E_{thr} = 1847.5$ lx.
3. For products classified as RG2 at 5000K $E_{thr} = 1315.8$ lx.
4. For products classified as RG2 at 6500K, $E_{thr} = 1124.5$ lx.
5. Please contact your Bridgelux sales representative for E_{thr} values at specific drive currents and CCTs not listed.

Product Bin Definitions

Table 8: 2-, 3- and 4-step MacAdam Ellipse Color Bin Definitions

CCT	Center Point		Degree	2-step		3-step		4-step	
	x	y	(°)	a	b	a	b	a	b
2700K	0.4578	0.4101	53.700	0.00540	0.00280	0.0081	0.0042	N/A	N/A
3000K	0.4338	0.403	53.217	0.00556	0.00272	0.0083	0.0041	N/A	N/A
4000K	0.3818	0.3797	53.717	0.00626	0.00268	0.0094	0.0040	N/A	N/A
5000K	0.3447	0.3553	59.617	N/A	N/A	0.0082	0.0035	0.0110	0.0047
5700K	0.3287	0.3417	59.060	N/A	N/A	0.0074	0.0032	0.0099	0.0042
6500K	0.3123	0.3282	58.567	N/A	N/A	0.0066	0.0028	0.0090	0.0038

Notes for Table 8:

1. Color binning at $T_c=85^\circ\text{C}$
2. Bridgelux maintains a tolerance of ± 0.007 on x and y color coordinates in the CIE 1931 color space.

Figure 9: C.I.E. 1931 Chromaticity Diagram (Color targeted at $T_c=85^\circ\text{C}$)

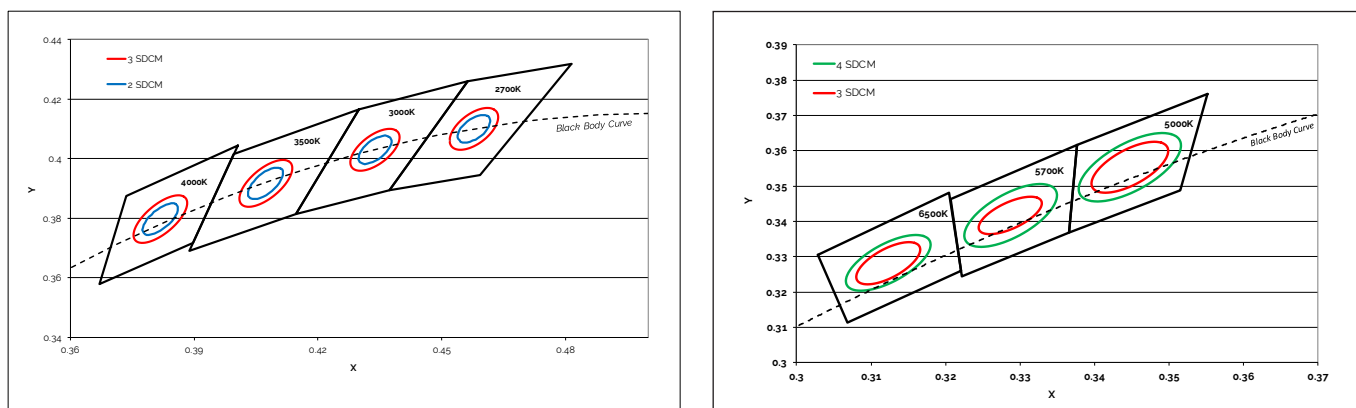

Performance Curves

Figure 10: V10B Drive Current vs. Voltage ($T_c=25^\circ\text{C}$)

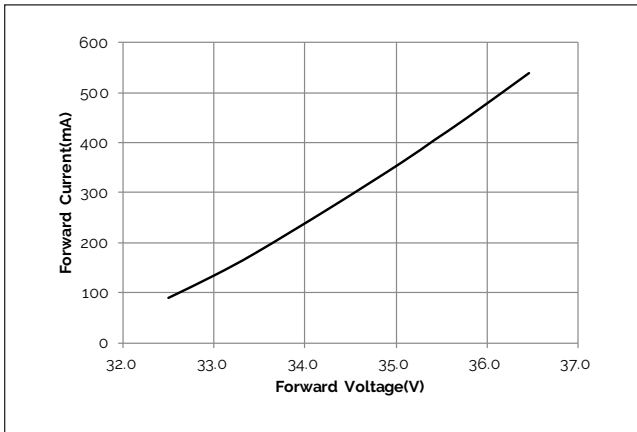

Figure 11: V10C Drive Current vs. Voltage ($T_c=25^\circ\text{C}$)

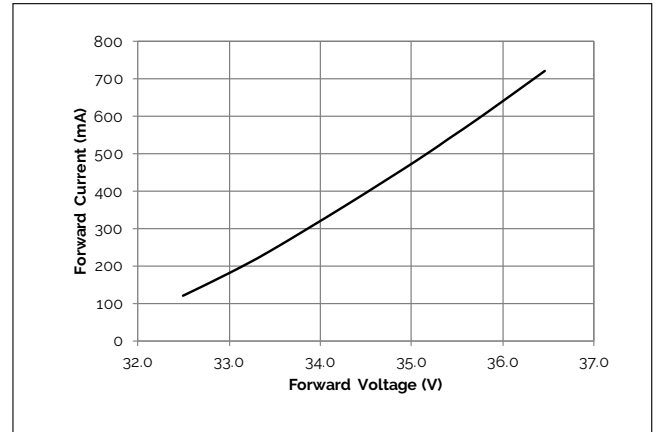

Figure 12: V10B Typical Relative Flux vs. Current ($T_c=25^\circ\text{C}$)

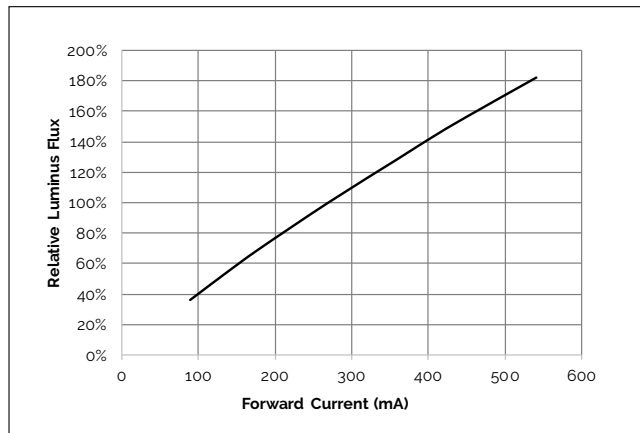
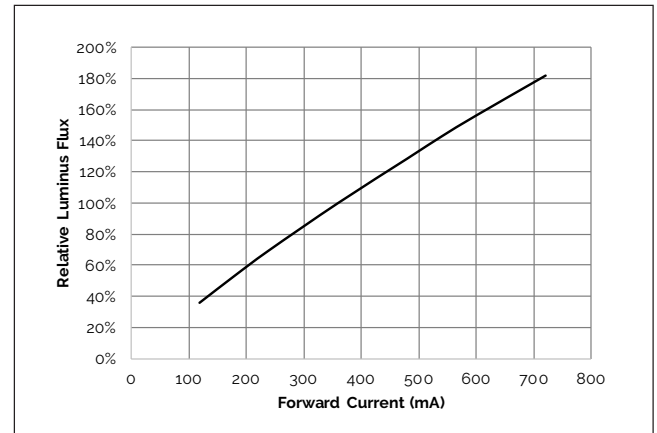

Figure 13: V10C Typical Relative Flux vs. Current ($T_c=25^\circ\text{C}$)



Performance Curves

Figure 14: Typical DC Flux vs. Case Temperature

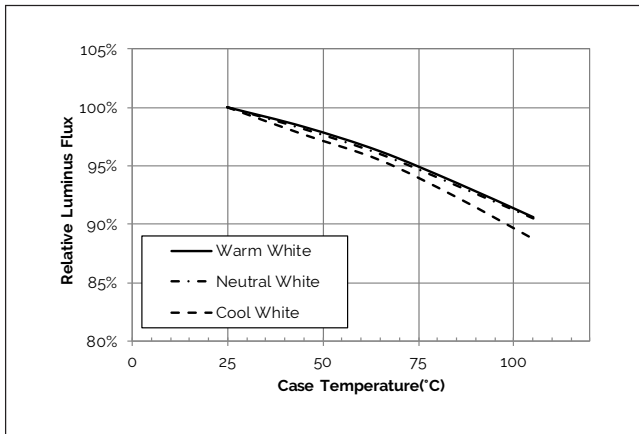

Figure 15: Typical ccx Shift vs. Case Temperature

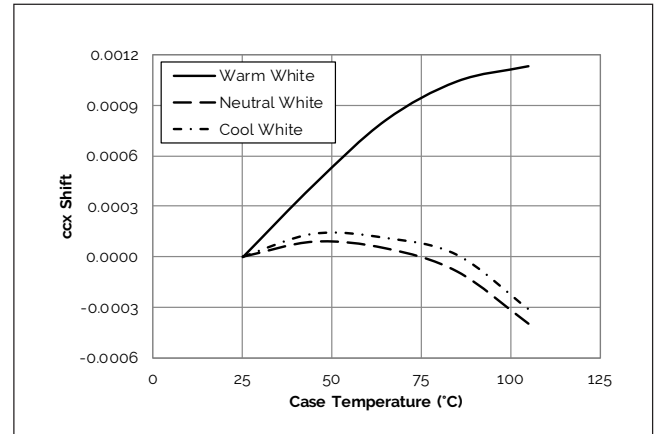
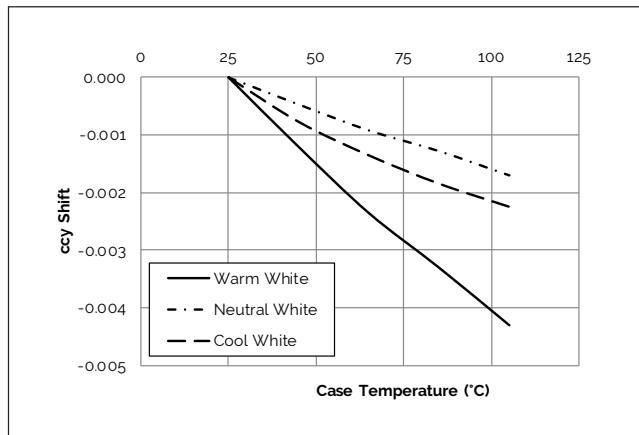

Figure 16: Typical ccy Shift vs. Case Temperature



Notes for Figures 14-16:

1. Bridgelux does not recommend driving high power LEDs at low currents. Doing so may produce unpredictable results. Pulse width modulation (PWM) is recommended for dimming effects.
2. Characteristics shown for warm white based on 3000K Thrive
3. Characteristics shown for neutral white based on 4000K Thrive
4. Characteristics shown for cool white based on 5000K Thrive
5. For other color SKUs, the shift in color will vary. Please contact your Bridgelux Sales Representative for more information.

Typical Radiation Pattern

Figure 17: Typical Spatial Radiation Pattern

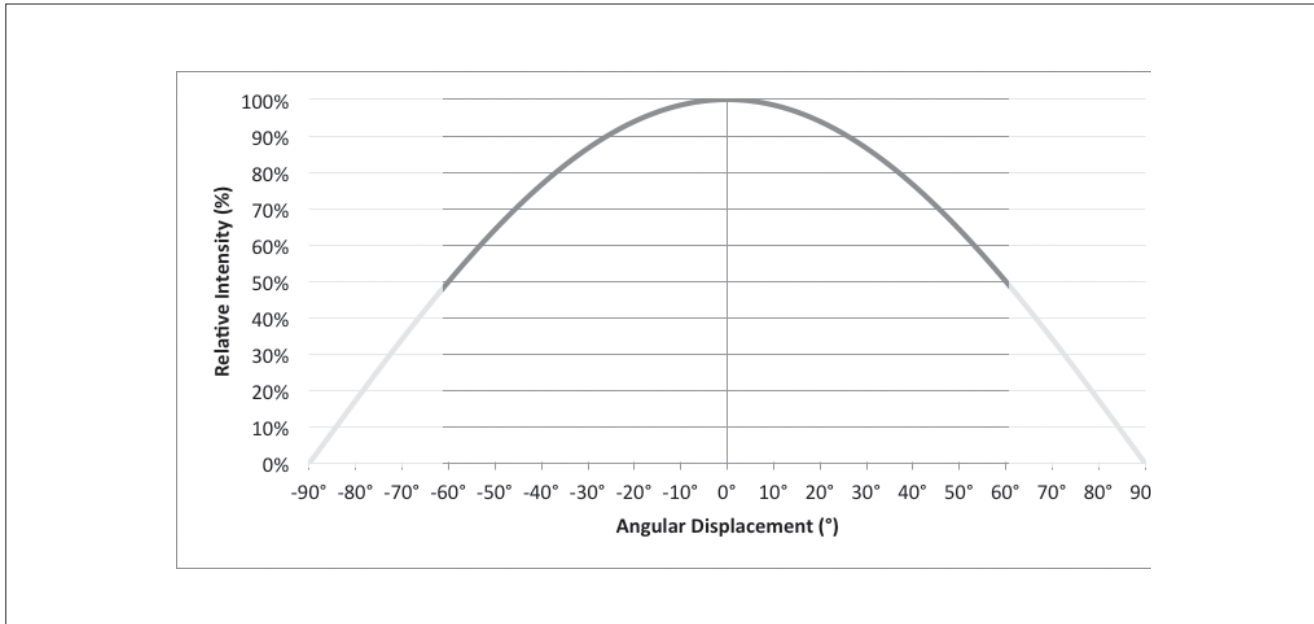

Notes for Figure 17:

1. Typical viewing angle is 120°.
2. The viewing angle is defined as the off axis angle from the centerline where intensity is ½ of the peak value.

Figure 18: Typical Polar Radiation Pattern

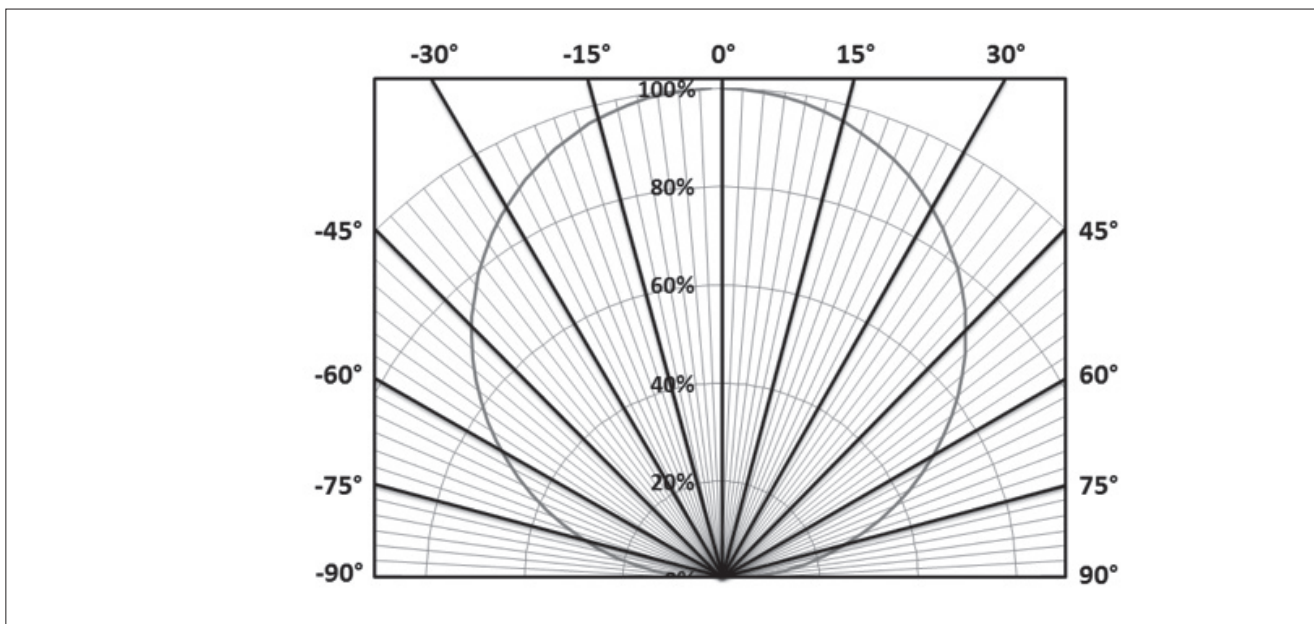

Mechanical Dimensions

Figure 19: V10 LED Array

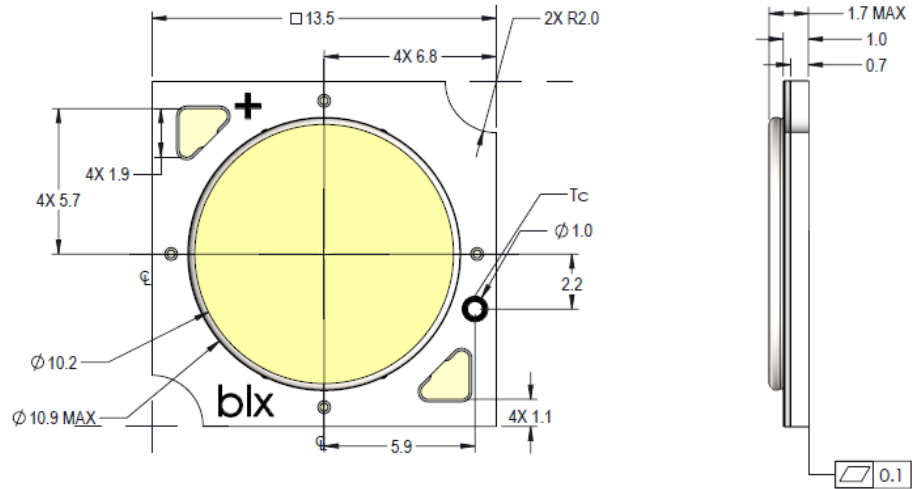

Notes for Figure 19:

1. Drawings are not to scale.
2. Drawing dimensions are in millimeters.
3. Unless otherwise specified, tolerances are ± 0.1 mm.
4. Mounting locations (2X) are for M2.5 screws.
5. Screws with flat shoulders (pan, dome, button, round, truss, mushroom) provide optimal torque control. Do NOT use flat, countersink, or raised head screws.
6. The optical center of the LED Array is nominally defined by the mechanical center of the array to a tolerance of ± 0.2 mm.
7. Bridgelux maintains a flatness of 0.10mm across the mounting surface of the array.

Packaging and Labeling

Figure 20: V10 Packaging



Notes for Figure 20:

1. Each tube holds 30 V10 COB arrays.
2. One tube is sealed in an anti-static bag. Four bags are placed in a shipping box. Depending on quantities ordered, a bigger shipping box, containing four boxes may be used to ship products.
3. Each bag and box is to be labeled as shown above.
4. Dimensions for each tube are 8.3 (W) x 15.4 (H) x 430 (L). Dimensions for the anti-static bag are 75 (W) x 615 (L) x 3.1 (T) mm. Dimensions for the shipping box are 58.7 x 13.3 x 7.9 cm

Packaging and Labeling

Figure 21: Gen. 7 Product Labeling

Bridgelux COB arrays have laser markings on the back side of the substrate to help with product identification. In addition to the product identification markings, Bridgelux COB arrays also contain markings for internal Bridgelux manufacturing use only. The image below shows which markings are for customer use and which ones are for Bridgelux internal use only. The Bridgelux internal manufacturing markings are subject to change without notice, however these will not impact the form, function or performance of the COB array.



Design Resources

Application Notes

Bridgelux has developed a comprehensive set of application notes and design resources to assist customers in successfully designing with the V Series product family of LED array products. For all available application notes visit www.bridgelux.com.

Optical Source Models

Optical source models and ray set files are available for all Bridgelux products. For a list of available formats, visit www.bridgelux.com.

3D CAD Models

Three dimensional CAD models depicting the product outline of all Bridgelux V Series LED arrays are available in both IGS and STEP formats. Please contact your Bridgelux sales representative for assistance.

LM80

LM80 testing has been completed and the LM80 report is now available. Please contact your Bridgelux sales representative for LM-80 report.

Precautions

CAUTION: CHEMICAL EXPOSURE HAZARD

Exposure to some chemicals commonly used in luminaire manufacturing and assembly can cause damage to the LED array. Please consult Bridgelux Application Note AN101 for additional information.

CAUTION: RISK OF BURN

Do not touch the V Series LED array during operation. Allow the array to cool for a sufficient period of time before handling. The V Series LED array may reach elevated temperatures such that could burn skin when touched.

CAUTION

CONTACT WITH LIGHT EMITTING SURFACE (LES)

Avoid any contact with the LES. Do not touch the LES of the LED array or apply stress to the LES (yellow phosphor resin area). Contact may cause damage to the LED array.

Optics and reflectors must not be mounted in contact with the LES (yellow phosphor resin area).

Disclaimers

MINOR PRODUCT CHANGE POLICY

The rigorous qualification testing on products offered by Bridgelux provides performance assurance. Slight cosmetic changes that do not affect form, fit, or function may occur as Bridgelux continues product optimization.

STANDARD TEST CONDITIONS

Unless otherwise stated, array testing is performed at the nominal drive current.

About Bridgelux: Bridging Light and Life™

At Bridgelux, we help companies, industries and people experience the power and possibility of light. Since 2002, we've designed LED solutions that are high performing, energy efficient, cost effective and easy to integrate. Our focus is on light's impact on human behavior, delivering products that create better environments, experiences and returns—both experiential and financial. And our patented technology drives new platforms for commercial and industrial luminaires.

For more information about the company, please visit

bridgelux.com

twitter.com/Bridgelux

facebook.com/Bridgelux

linkedin.com/company/bridgelux-inc-_2

youtube.com/user/Bridgelux

WeChat ID: BridgeluxInChina



46430 Fremont Boulevard

Fremont, CA 94538 USA

Tel (925) 583-8400

www.bridgelux.com

X-ON Electronics

Largest Supplier of Electrical and Electronic Components

Click to view similar products for [High Power LEDs - White category:](#)

Click to view products by [Bridgelux manufacturer:](#)

Other Similar products are found below :

[G42180-08](#) [B42180-08](#) [STW8Q2PA-R5-HA](#) [SZ5-M1-W0-00-V3/W2-AA](#) [LTPL-P00DWS57](#) [LZP-D0WW00-0000](#) [CLM-9-30-90-36-AC32-F4-3](#) [SZ5-M1-WW-C8-V1/V3-FA](#) [BXRC-27E2000-D-73](#) [BXRC-27G2000-D-73](#) [BXRC-30E1000-D-73](#) [BXRC-30G2000-D-73](#) [BXRC-40E1000-D-73](#) [BXRE-30G2000-B-73](#) [BXRE-30G2000-C-73](#) [BXRE-50C2001-C-74](#) [CXM-22-27-80-54-AC30-F4-3](#) [XHP50B-00-0000-0D0UH245G](#) [XHP50B-00-0000-0D0UH240G](#) [XHP50B-00-0000-0D0UG227H](#) [XHP50B-00-0000-0D0HJ245G](#) [MP-5050-8100-27-80](#) [MP-5050-6100-65-80](#) [MP-5050-6100-50-80](#) [MP-5050-6100-40-80](#) [MP-5050-6100-30-80](#) [CXM-22-30-80-54-AC30-F4-3](#) [LTW-2835SZK57](#) [BXEM-50C0000-0-000](#) [WW-WNA30TS-U1\(M1\)](#) [KW CSLPM2.CC-8L8M-4L8N](#) [KW CSLPM2.CC-8L8M-4O9Q](#) [KW DPLS32.SB-6H6J-E5P7-EG-Z264](#) [L1V1-507003V500000](#) [CXM-22-35-80-36-AC10-F3-3](#) [KW3 CGLNM1.TG-Z6QF6-EBVFFCBB46-DFGA](#) [JB5630AWT-H-H65EA0000-NZ000001](#) [XHP50B-00-0000-0D0UG430H](#) [CXM-22-35-90-54-AC40-F5-3](#) [CXM-22-35-80-54-AC40-F5-3](#) [OSM51206E1N-0.8T](#) [OSW43020C1C](#) [MP161611032290](#) [MP-1616-2103-50-90](#) [KW CULPM1.TG-Z6RF7-ebvFfcbB46-65G5](#) [KW DMLS33.SG-Z6M7-EBVFFCBB46-8E8G-700-S](#) [XPGDWT-B1-0000-00EEA](#) [XHP70B-00-0000-0D0BP450E](#) [KW DMLN33.SG-7J7K-EBVFFCBB46-8E8G-200-S](#) [ASMT-MW05-NMNS1](#)