

# Bridgelux® Gen 8 V4 HD LED Array

Product Data Sheet DS404



# Introduction

V Series HD

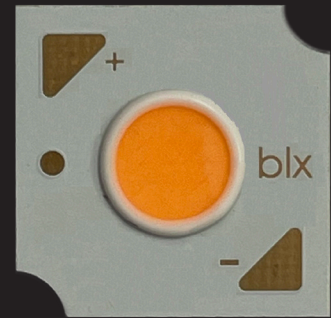

V Series™ HD LED array product, an ultra-high lumen density COB product line, is designed for high intensity spotlights used in commercial and retail settings. V Series HD arrays offer industry leading color over angle uniformity, and replace ceramic metal halide lamps by providing equal or greater center beam candle power at lower power and at greater lifetimes. Their tight beam control and exceptional quality of light is well suited for demanding directional spot applications.

The V4 HD LED array is available in a variety of CCT and CRI combinations providing substantial design flexibility and energy efficiencies.

Lighting system designs incorporating these LED arrays deliver increased system level efficacy and longer service life. Typical applications include, but are not limited to, commercial and residential down lights, accent, spot and track lights.

Bridgelux Décor Series™ is our state of the art color line designed specifically for premium applications, producing unmatched LED light quality with brilliant color-rendering options and offer pleasing and inspiring lighting palettes. Bridgelux Décor Series color points are available on Vero® SE Series, Vero® Series, V Series™ and V Series™ HD.

**Décor Series™ Ultra** products provide a high CRI of 97 and a minimum Rg value of 91, which emphasizes the reds and color tones to which the human eye is most receptive - perfect for the most luxurious retail shops and world renowned museums. Décor Series Ultra is designed as a replacement for halogen.

## Features

- Efficacy of 134 lm/W typical
- Compact high flux density light source
- Uniform high quality illumination
- Minimum 80, 90 and 95 CRI options
- Streamlined thermal path
- ENERGY STAR® / ANSI compliant color binning structure with 3 SDCM options
- More energy efficient than incandescent, halogen and fluorescent lamps
- Low voltage DC operation
- Instant light with unlimited dimming

## Benefits

- Enhanced optical control
- Clean white light without pixelation
- High quality true color reproduction
- Significantly reduced thermal resistance and increased operating temperatures
- Uniform consistent white light
- Lower operating costs
- Easy to use with daylight and motion detectors to enable increased energy savings
- Reduced maintenance costs
- Environmentally friendly, no disposal issue



# Contents

Product Feature Map	2
Product Nomenclature	2
Product Selection Guide	3
Performance at Commonly Used Drive Currents	5
Electrical Characteristics	9
Eye Safety	10
Absolute Maximum Ratings	11
Performance Curves	12
Typical Radiation Pattern	14
Typical Color Spectrum	15
Mechanical Dimensions	16
Color Binning Information	17
Packaging and Labeling	18
Design Resources	20
Precautions	20
Disclaimers	20
About Bridgelux	21

# Product Feature Map

Bridgelux arrays are fully engineered devices that provide consistent thermal and optical performance on an engineered mechanical platform. The V Series HD arrays are the most compact chip-on-board devices across all of Bridgelux's LED Array products.

The arrays incorporate several features to simplify design integration and assembly. Please visit [www.bridgelux.com](http://www.bridgelux.com) for more information on the V Series HD family of products.

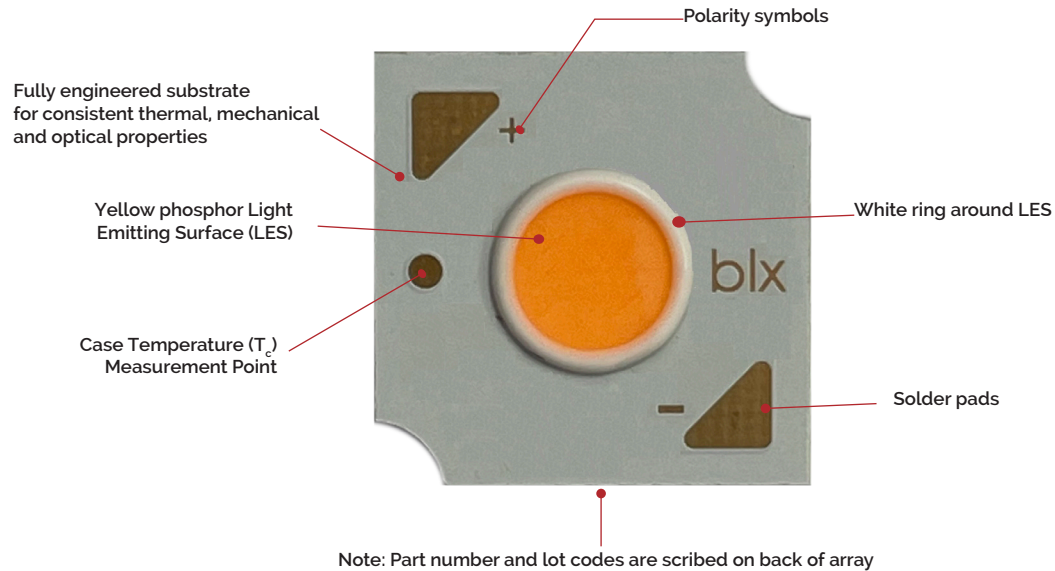

## Product Nomenclature

The part number designation for Bridgelux V Series HD LED arrays is explained as follows:

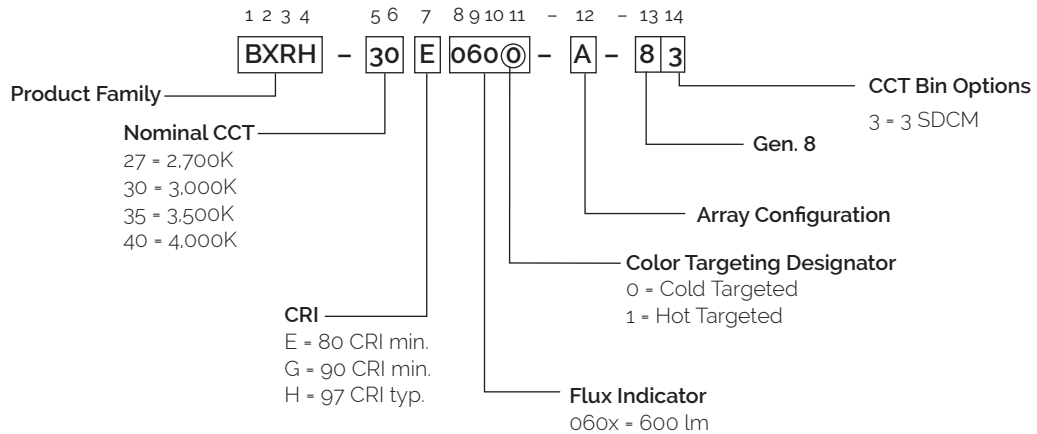

# Product Selection Guide

The following product configurations are available:

**Table 1:** Selection Guide, Pulsed Measurement Data ( $T_j = T_c = 25^\circ\text{C}$ )

Part Number	Nominal CCT <sup>1</sup> (K)	CRI <sup>2</sup>	Nominal Drive Current <sup>3</sup> (mA)	Typical Pulsed Flux <sup>4,5,6</sup> $T_c = 25^\circ\text{C}$ (lm)	Minimum Pulsed Flux <sup>6,7</sup> $T_c = 25^\circ\text{C}$ (lm)	Typical $V_f$ (V)	Typical Power (W)	Typical Efficacy (lm/W)
BXRH-25E0600-B-8x	2500	80	350	781	703	18.3	6.4	122
BXRH-27E0600-A-8x	2700	80	175	817	735	36.6	6.4	128
BXRH-27E0600-B-8x	2700	80	350	817	735	18.3	6.4	128
BXRH-27G0600-A-8x	2700	90	175	674	607	36.6	6.4	105
BXRH-27G0600-B-8x	2700	90	350	674	607	18.3	6.4	105
BXRH-27H0600-A-8x	2700	97	175	597	538	36.6	6.4	93
BXRH-27H0600-B-8x	2700	97	350	597	538	18.3	6.4	93
BXRH-30E0600-A-8x	3000	80	175	868	781	36.6	6.4	136
BXRH-30E0600-B-8x	3000	80	350	868	781	18.3	6.4	136
BXRH-30G0600-A-8x	3000	90	175	705	634	36.6	6.4	110
BXRH-30G0600-B-8x	3000	90	350	705	634	18.3	6.4	110
BXRH-30H0600-A-8x	3000	90	175	638	574	36.6	6.4	100
BXRH-30H0600-B-8x	3000	90	350	638	574	18.3	6.4	100
BXRH-35E0600-A-8x	3000	90	175	888	800	36.6	6.4	139
BXRH-35E0600-B-8x	3000	90	350	888	800	18.3	6.4	139
BXRH-35G0600-A-8x	3500	90	175	730	657	36.6	6.4	114
BXRH-35G0600-B-8x	3500	90	350	730	657	18.3	6.4	114
BXRH-35H0600-A-8x	3500	97	175	656	590	36.6	6.4	102
BXRH-35H0600-B-8x	3500	97	350	656	590	18.3	6.4	102
BXRH-40E0600-A-8x	4000	80	175	894	804	36.6	6.4	140
BXRH-40E0600-B-8x	4000	80	350	894	804	18.3	6.4	140
BXRH-40G0600-A-8x	4000	90	175	745	671	36.6	6.4	116
BXRH-40G0600-B-8x	4000	90	350	745	671	18.3	6.4	116
BXRH-40H0600-A-8x	4000	97	175	674	607	36.6	6.4	105
BXRH-40H0600-B-8x	4000	97	350	674	607	18.3	6.4	105

Notes for Table 1:

- Nominal CCT as defined by ANSI C78.377-2011.
- CRI values are typical for Decor Series Ultra. CRI values are minimums for all other products. Minimum Rg value for 80 CRI products is 0, the minimum Rg values for 90 CRI products is 50, the minimum Rg values for 97 CRI products is 91. Bridgelux maintains a  $\pm 3$  tolerance on CRI and Rg values.
- Drive current is referred to as nominal drive current.
- Products tested under pulsed condition (10ms pulse width) at nominal test current where  $T_j$  (junction temperature) -  $T_c$  (case temperature) =  $25^\circ\text{C}$ .
- Typical performance values are provided as a reference only and are not a guarantee of performance.
- Bridgelux maintains a  $\pm 7\%$  tolerance on flux measurements.
- Minimum flux values at the nominal test current are guaranteed by 100% test.

# Product Selection Guide

**Table 2:** Selection Guide, Stabilized DC Performance ( $T_c = 85^\circ\text{C}$ )

Part Number	Nominal CCT <sup>1</sup> (K)	CRI <sup>2</sup>	Nominal Drive Current <sup>3</sup> (mA)	Typical DC Flux <sup>4,5</sup> $T_c = 85^\circ\text{C}$ (lm)	Minimum DC Flux <sup>6</sup> $T_c = 85^\circ\text{C}$ (lm)	Typical $V_f$ (V)	Typical Power (W)	Typical Efficacy (lm/W)
BXRH-25E0600-B-8x	2500	80	350	703	633	177	6.2	113
BXRH-27E0600-A-8x	2700	80	175	735	662	35.4	6.2	119
BXRH-27E0600-B-8x	2700	80	350	735	662	177	6.2	119
BXRH-27G0600-A-8x	2700	90	175	607	546	35.4	6.2	98
BXRH-27G0600-B-8x	2700	90	350	607	546	177	6.2	98
BXRH-27H0600-A-8x	2700	97	175	538	484	35.4	6.2	87
BXRH-27H0600-B-8x	2700	97	350	538	484	177	6.2	87
BXRH-30E0600-A-8x	3000	80	175	781	703	35.4	6.2	126
BXRH-30E0600-B-8x	3000	80	350	781	703	177	6.2	126
BXRH-30G0600-A-8x	3000	90	175	634	571	35.4	6.2	102
BXRH-30G0600-B-8x	3000	90	350	634	571	177	6.2	102
BXRH-30H0600-A-8x	3000	97	175	574	517	35.4	6.2	93
BXRH-30H0600-B-8x	3000	97	350	574	517	177	6.2	93
BXRH-35E0600-A-8x	3500	80	175	800	720	35.4	6.2	129
BXRH-35E0600-B-8x	3500	80	350	800	720	177	6.2	129
BXRH-35G0600-A-8x	3500	90	175	657	591	35.4	6.2	106
BXRH-35G0600-B-8x	3500	90	350	657	591	177	6.2	106
BXRH-35H0600-A-8x	3500	97	175	590	531	35.4	6.2	95
BXRH-35H0600-B-8x	3500	97	350	590	531	177	6.2	95
BXRH-40E0600-A-8x	4000	80	175	804	724	35.4	6.2	130
BXRH-40E0600-B-8x	4000	80	350	804	724	177	6.2	130
BXRH-40G0600-A-8x	4000	90	175	671	604	35.4	6.2	108
BXRH-40G0600-B-8x	4000	90	350	671	604	177	6.2	108
BXRH-40H0600-A-8x	4000	97	175	607	546	35.4	6.2	98
BXRH-40H0600-B-8x	4000	97	350	607	546	177	6.2	98

Notes for Table 2:

- Nominal CCT as defined by ANSI C78.377-2011.
- All CRI values are measured at  $T_s = T_c = 25^\circ\text{C}$ . CRI values are typical for Decor Series Ultra. CRI values are minimums for all other products. Minimum R<sub>g</sub> value for 80 CRI products is 0, the minimum R<sub>g</sub> values for 90 CRI products is 50, the minimum R<sub>g</sub> values for 97 CRI products is 91. Bridgelux maintains a  $\pm 3$  tolerance on CRI and R<sub>g</sub> values.
- Drive current is referred to as nominal drive current.
- Typical stabilized DC performance values are provided as reference only and are not a guarantee of performance.
- Typical performance is estimated based on operation under DC (direct current) with LED array mounted onto a heat sink with thermal interface material and the case temperature maintained at  $85^\circ\text{C}$ . Based on Bridgelux test setup, values may vary depending on the thermal design of the luminaire and/or the exposed environment to which the product is subjected.
- Minimum flux values at elevated temperatures are provided for reference only and are not guaranteed by 100% production testing. Based on Bridgelux test setup, values may vary depending on the thermal design of the luminaire and/or the exposed environment to which the product is subjected.

# Performance at Commonly Used Drive Currents

V Series HD LED arrays are tested to the specifications shown using the nominal drive currents in Table 1. V Series HD LED arrays may also be driven at other drive currents dependent on specific application design requirements. The performance at any drive current can be derived from the current vs. voltage characteristics shown in Figures 1 & 2 and the flux vs. current characteristics shown in Figures 3 & 4. The performance at commonly used drive currents is summarized in Table 3.

**Table 3:** Product Performance at Commonly Used Drive Currents

Part Number	CRI	Drive Current <sup>1</sup> (mA)	Typical V <sub>f</sub> T <sub>c</sub> = 25°C (V)	Typical Power T <sub>c</sub> = 25°C (W)	Typical Flux <sup>2</sup> T <sub>c</sub> = 25°C (lm)	Typical DC Flux <sup>3</sup> T <sub>c</sub> = 85°C (lm)	Typical Efficacy T <sub>c</sub> = 25°C (lm/W)
BXRH-25E0600-B-8x	80	170	17.1	2.9	409	368	141
		260	17.7	4.6	601	541	130
		<b>350</b>	<b>18.3</b>	<b>6.4</b>	<b>781</b>	<b>703</b>	<b>122</b>
		440	18.9	8.3	949	854	114
		480	19.1	9.2	1020	918	111
		600	19.7	11.8	1217	1095	103
BXRH-27E0600-A-8x	80	85	34.1	2.9	427	385	147
		130	35.5	4.6	629	566	136
		<b>175</b>	<b>36.6</b>	<b>6.4</b>	<b>817</b>	<b>735</b>	<b>128</b>
		220	37.8	8.3	993	893	119
		240	38.2	9.2	1066	960	116
		300	39.5	11.8	1273	1146	107
BXRH-27E0600-B-8x	80	170	17.1	2.9	427	385	147
		260	17.7	4.6	629	566	136
		<b>350</b>	<b>18.3</b>	<b>6.4</b>	<b>817</b>	<b>735</b>	<b>128</b>
		440	18.9	8.3	993	893	119
		480	19.1	9.2	1066	960	116
		600	19.7	11.8	1273	1146	107
BXRH-27G0600-A-8x	90	85	34.1	2.9	353	317	121
		130	35.5	4.6	519	467	113
		<b>175</b>	<b>36.6</b>	<b>6.4</b>	<b>674</b>	<b>607</b>	<b>105</b>
		220	37.8	8.3	819	737	99
		240	38.2	9.2	880	792	96
		300	39.5	11.8	1050	945	89
BXRH-27G0600-B-8x	90	170	17.1	2.9	353	317	121
		260	17.7	4.6	519	467	113
		<b>350</b>	<b>18.3</b>	<b>6.4</b>	<b>674</b>	<b>607</b>	<b>105</b>
		440	18.9	8.3	819	737	99
		480	19.1	9.2	880	792	96
		600	19.7	11.8	1050	945	89
BXRH-27H0600-A-8x	97	85	34.1	2.9	312	281	108
		130	35.5	4.6	460	414	100
		<b>175</b>	<b>36.6</b>	<b>6.4</b>	<b>597</b>	<b>538</b>	<b>93</b>
		220	37.8	8.3	726	653	87
		240	38.2	9.2	780	702	85
		300	39.5	11.8	931	838	79

Notes for Table 3:

1. Alternate drive currents are provided for reference only and are not a guarantee of performance.
2. Bridgelux maintains a ± 7% tolerance on flux measurements.
3. Typical stabilized DC performance values are provided as reference only and are not a guarantee of performance.

# Performance at Commonly Used Drive Currents

**Table 3:** Product Performance at Commonly Used Drive Currents (continued)

Part Number	CRI	Drive Current <sup>1</sup> (mA)	Typical V <sub>f</sub> T <sub>c</sub> = 25°C (V)	Typical Power T <sub>c</sub> = 25°C (W)	Typical Flux <sup>2</sup> T <sub>c</sub> = 25°C (lm)	Typical DC Flux <sup>3</sup> T <sub>c</sub> = 85°C (lm)	Typical Efficacy T <sub>c</sub> = 25°C (lm/W)
BXRH-27H0600-B-8x	97	170	17.1	2.9	312	281	108
		260	17.7	4.6	460	414	100
		<b>350</b>	<b>18.3</b>	<b>6.4</b>	<b>597</b>	<b>538</b>	<b>93</b>
		440	18.9	8.3	726	653	87
		480	19.1	9.2	780	702	85
		600	19.7	11.8	931	838	79
BXRH-30E0600-A-8x	80	85	34.1	2.9	454	409	156
		130	35.5	4.6	668	601	145
		<b>175</b>	<b>36.6</b>	<b>6.4</b>	<b>868</b>	<b>781</b>	<b>136</b>
		220	37.8	8.3	1055	949	127
		240	38.2	9.2	1133	1020	123
		300	39.5	11.8	1352	1217	114
BXRH-30E0600-B-8x	80	170	17.1	2.9	454	409	156
		260	17.7	4.6	668	601	145
		<b>350</b>	<b>18.3</b>	<b>6.4</b>	<b>868</b>	<b>781</b>	<b>136</b>
		440	18.9	8.3	1055	949	127
		480	19.1	9.2	1133	1020	123
		600	19.7	11.8	1352	1217	114
BXRH-30G0600-A-8x	90	85	34.1	2.9	369	332	127
		130	35.5	4.6	542	488	118
		<b>175</b>	<b>36.6</b>	<b>6.4</b>	<b>705</b>	<b>634</b>	<b>110</b>
		220	37.8	8.3	856	770	103
		240	38.2	9.2	920	828	100
		300	39.5	11.8	1098	988	93
BXRH-30G0600-B-8x	90	170	17.1	2.9	369	332	127
		260	17.7	4.6	542	488	118
		<b>350</b>	<b>18.3</b>	<b>6.4</b>	<b>705</b>	<b>634</b>	<b>110</b>
		440	18.9	8.3	856	770	103
		480	19.1	9.2	920	828	100
		600	19.7	11.8	1098	988	93
BXRH-30H0600-A-8x	90	85	34.1	2.9	334	300	115
		130	35.5	4.6	491	442	107
		<b>175</b>	<b>36.6</b>	<b>6.4</b>	<b>638</b>	<b>574</b>	<b>100</b>
		220	37.8	8.3	775	698	93
		240	38.2	9.2	833	750	91
		300	39.5	11.8	994	895	84
BXRH-30H0600-B-8x	90	170	17.1	2.9	334	300	115
		260	17.7	4.6	491	442	107
		<b>350</b>	<b>18.3</b>	<b>6.4</b>	<b>638</b>	<b>574</b>	<b>100</b>
		440	18.9	8.3	775	698	93
		480	19.1	9.2	833	750	91
		600	19.7	11.8	994	895	84

Notes for Table 3:

1. Alternate drive currents in Table 3 are provided for reference only and are not a guarantee of performance.
2. Bridgelux maintains a ± 7% tolerance on flux measurements.
3. Typical stabilized DC performance values are provided as reference only and are not a guarantee of performance.



# Performance at Commonly Used Drive Currents

**Table 3:** Product Performance at Commonly Used Drive Currents (continued)

Part Number	CRI	Drive Current <sup>1</sup> (mA)	Typical V <sub>f</sub> T <sub>c</sub> = 25°C (V)	Typical Power T <sub>c</sub> = 25°C (W)	Typical Flux <sup>2</sup> T <sub>c</sub> = 25°C (lm)	Typical DC Flux <sup>3</sup> T <sub>c</sub> = 85°C (lm)	Typical Efficacy T <sub>c</sub> = 25°C (lm/W)
BXRH-35E0600-A-8x	90	85	34.1	2.9	465	418	160
		130	35.5	4.6	684	615	148
		<b>175</b>	<b>36.6</b>	<b>6.4</b>	<b>888</b>	<b>800</b>	<b>139</b>
		220	37.8	8.3	1079	971	130
		240	38.2	9.2	1160	1044	126
		300	39.5	11.8	1384	1246	117
BXRH-35E0600-B-8x	90	170	17.1	2.9	465	418	160
		260	17.7	4.6	684	615	148
		<b>350</b>	<b>18.3</b>	<b>6.4</b>	<b>888</b>	<b>800</b>	<b>139</b>
		440	18.9	8.3	1079	971	130
		480	19.1	9.2	1160	1044	126
		600	19.7	11.8	1384	1246	117
BXRH-35G0600-A-8x	90	85	34.1	2.9	382	344	132
		130	35.5	4.6	562	506	122
		<b>175</b>	<b>36.6</b>	<b>6.4</b>	<b>730</b>	<b>657</b>	<b>114</b>
		220	37.8	8.3	887	798	107
		240	38.2	9.2	953	858	104
		300	39.5	11.8	1138	1024	96
BXRH-35G0600-B-8x	90	170	17.1	2.9	382	344	132
		260	17.7	4.6	562	506	122
		<b>350</b>	<b>18.3</b>	<b>6.4</b>	<b>730</b>	<b>657</b>	<b>114</b>
		440	18.9	8.3	887	798	107
		480	19.1	9.2	953	858	104
		600	19.7	11.8	1138	1024	96
BXRH-35H0600-A-8x	97	85	34.1	2.9	343	309	118
		130	35.5	4.6	505	454	110
		<b>175</b>	<b>36.6</b>	<b>6.4</b>	<b>656</b>	<b>590</b>	<b>102</b>
		220	37.8	8.3	797	717	96
		240	38.2	9.2	856	771	93
		300	39.5	11.8	1022	920	86
BXRH-35H0600-B-8x	97	170	17.1	2.9	343	309	118
		260	17.7	4.6	505	454	110
		<b>350</b>	<b>18.3</b>	<b>6.4</b>	<b>656</b>	<b>590</b>	<b>102</b>
		440	18.9	8.3	797	717	96
		480	19.1	9.2	856	771	93
		600	19.7	11.8	1022	920	86
BXRH-40E0600-A-8x	80	85	34.1	2.9	467	421	161
		130	35.5	4.6	688	619	149
		<b>175</b>	<b>36.6</b>	<b>6.4</b>	<b>894</b>	<b>804</b>	<b>140</b>
		220	37.8	8.3	1086	977	131
		240	38.2	9.2	1166	1050	127
		300	39.5	11.8	1392	1253	118

Notes for Table 3:

1. Alternate drive currents in Table 3 are provided for reference only and are not a guarantee of performance.
2. Bridgelux maintains a ± 7% tolerance on flux measurements.
3. Typical stabilized DC performance values are provided as reference only and are not a guarantee of performance.

# Performance at Commonly Used Drive Currents

**Table 3:** Product Performance at Commonly Used Drive Currents (continued)

Part Number	CRI	Drive Current <sup>1</sup> (mA)	Typical V <sub>f</sub> T <sub>c</sub> = 25°C (V)	Typical Power T <sub>c</sub> = 25°C (W)	Typical Flux <sup>2</sup> T <sub>c</sub> = 25°C (lm)	Typical DC Flux <sup>3</sup> T <sub>c</sub> = 85°C (lm)	Typical Efficacy T <sub>c</sub> = 25°C (lm/W)
BXRH-40E0600-B-8x	80	170	17.1	2.9	467	421	161
		260	17.7	4.6	688	619	149
		<b>350</b>	<b>18.3</b>	<b>6.4</b>	<b>894</b>	<b>804</b>	<b>140</b>
		440	18.9	8.3	1086	977	131
		480	19.1	9.2	1166	1050	127
		600	19.7	11.8	1392	1253	118
BXRH-40H0600-A-8x	97	85	34.1	2.9	353	317	121
		130	35.5	4.6	519	467	113
		<b>175</b>	<b>36.6</b>	<b>6.4</b>	<b>674</b>	<b>607</b>	<b>105</b>
		220	37.8	8.3	819	737	99
		240	38.2	9.2	880	792	96
		300	39.5	11.8	1050	945	89
BXRH-40H0600-B-8x	97	170	17.1	2.9	353	317	121
		260	17.7	4.6	519	467	113
		<b>350</b>	<b>18.3</b>	<b>6.4</b>	<b>674</b>	<b>607</b>	<b>105</b>
		440	18.9	8.3	819	737	99
		480	19.1	9.2	880	792	96
		600	19.7	11.8	1050	945	89
BXRH-40G0600-A-8x	90	85	34.1	2.9	390	351	134
		130	35.5	4.6	574	516	124
		<b>175</b>	<b>36.6</b>	<b>6.4</b>	<b>745</b>	<b>671</b>	<b>116</b>
		220	37.8	8.3	906	815	109
		240	38.2	9.2	973	876	106
		300	39.5	11.8	1161	1045	98
BXRH-40G0600-B-8x	90	170	17.1	2.9	390	351	134
		260	17.7	4.6	574	516	124
		<b>350</b>	<b>18.3</b>	<b>6.4</b>	<b>745</b>	<b>671</b>	<b>116</b>
		440	18.9	8.3	906	815	109
		480	19.1	9.2	973	876	106
		600	19.7	11.8	1161	1045	98

Notes for Table 3:

1. Alternate drive currents in Table 3 are provided for reference only and are not a guarantee of performance.
2. Bridgelux maintains a ± 7% tolerance on flux measurements.
3. Typical stabilized DC performance values are provided as reference only and are not a guarantee of performance.

# Electrical Characteristics

**Table 4:** Electrical Characteristics

Part Number	Drive Current (mA)	Forward Voltage Pulsed, $T_c = 25^\circ\text{C}$ (V) <sup>1, 2, 3, 8</sup>			Typical Coefficient of Forward Voltage <sup>4</sup> $\Delta V_f / \Delta T_c$ (mV/ $^\circ\text{C}$ )	Typical Thermal Resistance Junction to Case <sup>5,6</sup> $R_{j-c}$ ( $^\circ\text{C}/\text{W}$ )	Driver Selection Voltages <sup>7</sup> (V)	
		Minimum	Typical	Maximum			$V_f$ Min. Hot $T_c = 105^\circ\text{C}$ (V)	$V_f$ Max. Cold $T_c = -40^\circ\text{C}$ (V)
BXRH-xxx060x-A-8x	175	33.9	36.6	39.3	-20.00	1.43	32.3	40.6
	300	36.5	39.5	42.5	-21.58	1.67	34.8	43.9
BXRH-xxx060x-B-8x	350	16.9	18.3	19.7	-10.00	1.43	16.1	20.3
	600	18.2	19.7	21.2	-10.77	1.67	17.4	21.9

Notes for Table 4:

- Parts are tested in pulsed conditions,  $T_c = 25^\circ\text{C}$ . Pulse width is 10ms.
- Voltage minimum and maximum are provided for reference only and are not a guarantee of performance.
- Bridgelux maintains a tester tolerance of  $\pm 0.10\text{V}$  on forward voltage measurements.
- Typical coefficient of forward voltage tolerance is  $\pm 0.1\text{mV}$  for nominal current.
- Thermal resistance values are based from test data of a 3000K 80 CRI product.
- Thermal resistance value was calculated using total electrical input power; optical power was not subtracted from input power. The thermal interface material used during testing is not included in the thermal resistance value.
- $V_f$  min hot and max cold values are provided as reference only and are not guaranteed by test. These values are provided to aid in driver design and selection over the operating range of the product.
- This product has been designed and manufactured per IEC 62031:2018. This product has passed dielectric withstand voltage testing at 500 V. The working voltage designated for the insulation is 50V d.c. The maximum allowable voltage across the array must be determined in the end product application.

# Eye Safety

**Table 5:** Eye Safety Risk Group (RG) Classifications

Part Number	Drive Current (mA)	CCT <sup>1,3</sup>	
		2700K/3000K	4000K <sup>2</sup>
BXRH-xxx060x-A-8x	175	RG1	RG1
	300	RG1	RG2
BXRH-xxx060x-B-8x	350	RG1	RG1
	600	RG1	RG2

Notes for Table 5:

1. Eye safety classification for the use of Bridgelux V Series HD LED arrays is in accordance with specification IEC/TR 62778: Application of IEC 62471 for the assessment of blue light hazard to light sources and luminaires.
2. For products classified as RG2 at 4000K,  $E_{thr} = 1760$  lx.
3. Please contact your Bridgelux sales representative for  $E_{thr}$  values at specific drive currents and CCTs not listed.

# Absolute Maximum Ratings

**Table 6:** Maximum Ratings

Parameter	Maximum Rating	
LED Junction Temperature (T <sub>J</sub> )	125°C	
Storage Temperature	-40°C to +105°C	
Operating Case Temperature <sup>1</sup> (T <sub>C</sub> )	105°C	
Soldering Temperature <sup>2</sup>	300°C or lower for a maximum of 6 seconds	
	BXRH-xxx060x-A-8x	BXRH-xxx060x-B-8x
Maximum Drive Current <sup>3</sup>	300 mA	600 mA
Maximum Peak Pulsed Drive Current <sup>4</sup>	340 mA	680 mA
Maximum Reverse Voltage <sup>5</sup>	-30V	-60V

Notes for Table 6:

1. For IEC 62717 requirement, please consult your Bridgelux sales representative.
2. Refer to Bridgelux Application Note AN101: Handling and Assembly of Bridgelux V Series LED Arrays.
3. Arrays may be driven at higher currents however lumen maintenance may be reduced and warranty will not apply.
4. Bridgelux recommends a maximum duty cycle of 10% and pulse width of 20 ms when operating LED Arrays at maximum peak pulsed current specified. Maximum peak pulsed currents indicate values where LED Arrays can be driven without catastrophic failures.
5. Light emitting diodes are not designed to be driven in reverse voltage and will not produce light under this condition. Maximum rating provided for reference only.

# Performance Curves

**Figure 1: V4A HD Drive Current vs. Voltage ( $T_j = T_c = 25^\circ\text{C}$ )<sup>1</sup>**

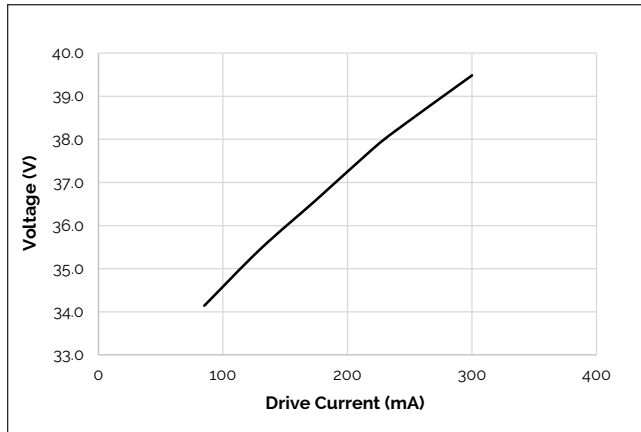

**Figure 2: V4B HD Drive Current vs. Voltage ( $T_j = T_c = 25^\circ\text{C}$ )<sup>1</sup>**

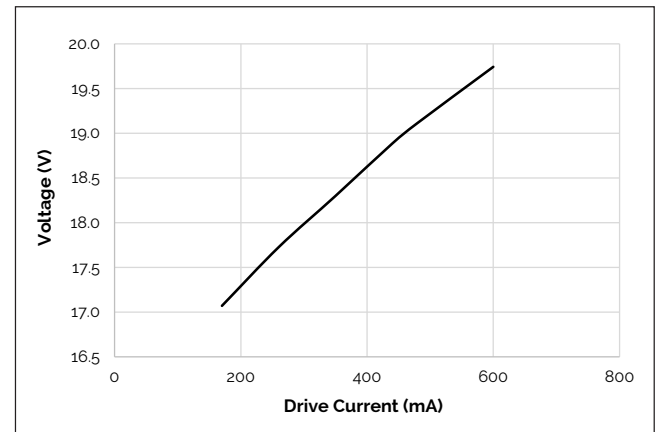

**Figure 3: V4A HD Typical Relative Luminous Flux vs. Drive Current ( $T_j = T_c = 25^\circ\text{C}$ )<sup>1</sup>**

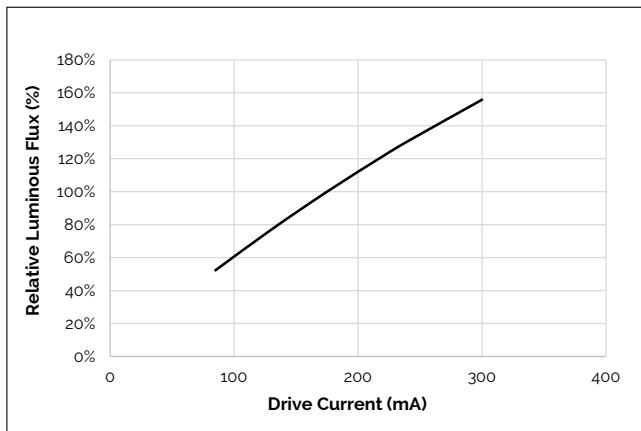

**Figure 4: V4B HD Typical Relative Luminous Flux vs. Drive Current ( $T_j = T_c = 25^\circ\text{C}$ )<sup>1</sup>**

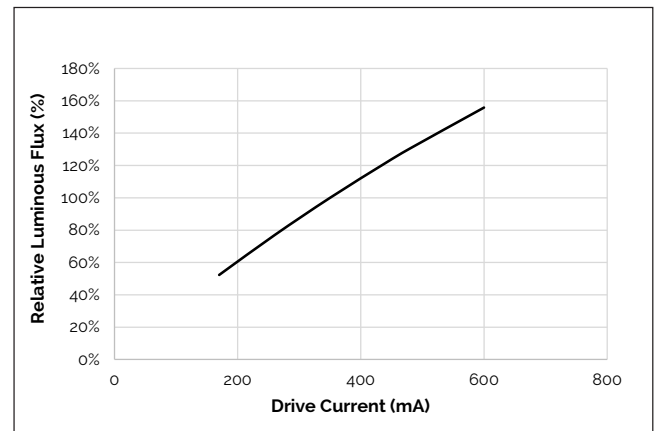

**Figure 5: Typical DC Flux vs. Case Temperature**

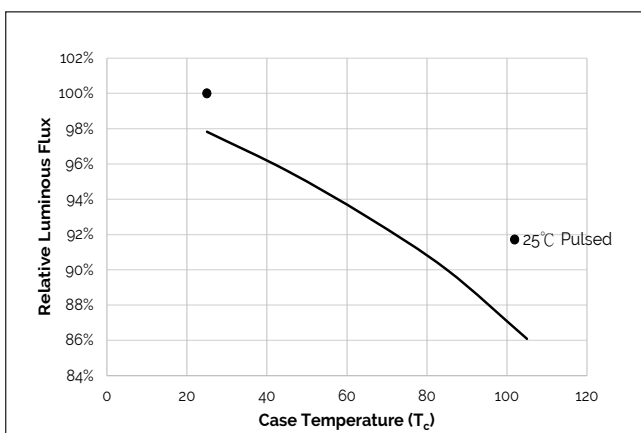

**Figure 6: Typical DC cxx Shift vs. Case Temperature**

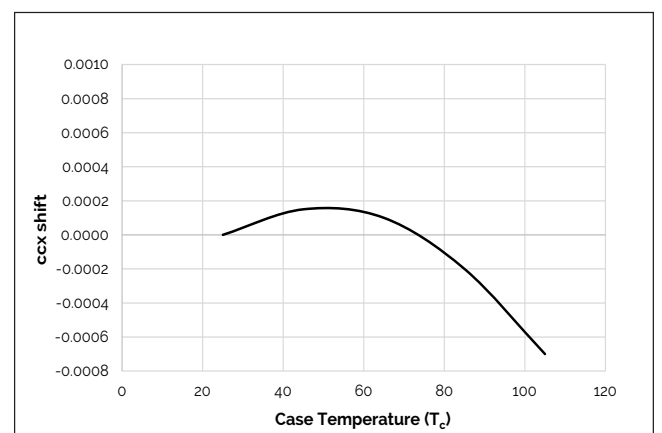

Notes for Figures 1 - 6:

1. Bridgelux does not recommend driving high power LEDs at low currents. Doing so may produce unpredictable results. Pulse width modulation (PWM) is recommended for dimming effects.
2. Characteristics shown for 3000K and 90 CRI.

# Performance Curves

**Figure 7: Typical DC ccy Shift vs. Case Temperature**

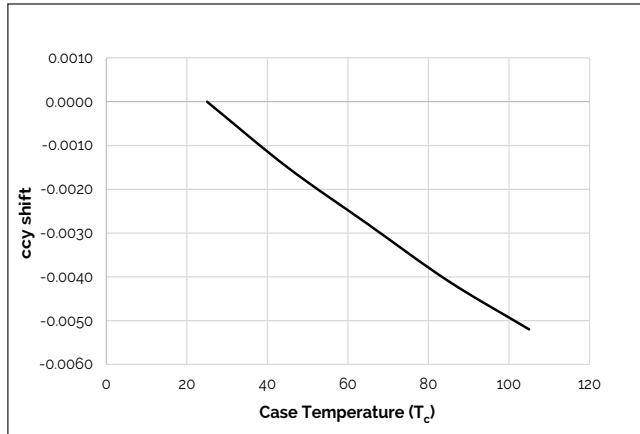

**Figure 8: Derating Curve**

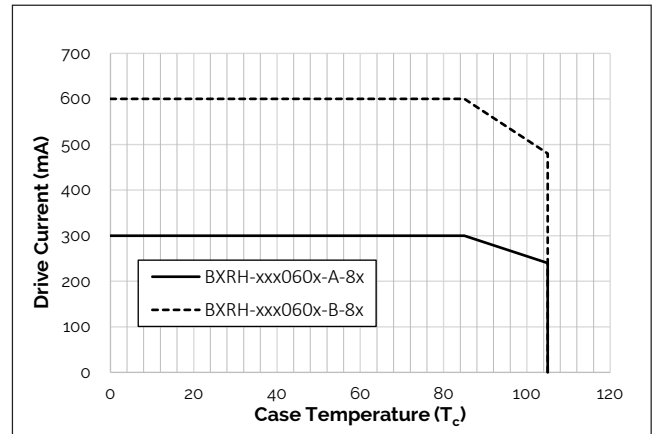

Notes for Figures 7:

1. Bridgelux does not recommend driving high power LEDs at low currents. Doing so may produce unpredictable results. Pulse width modulation (PWM) is recommended for dimming effects.
2. Characteristics shown for 3000K and 90 CRI.

# Typical Radiation Pattern

Figure 9: Typical Spatial Radiation Pattern

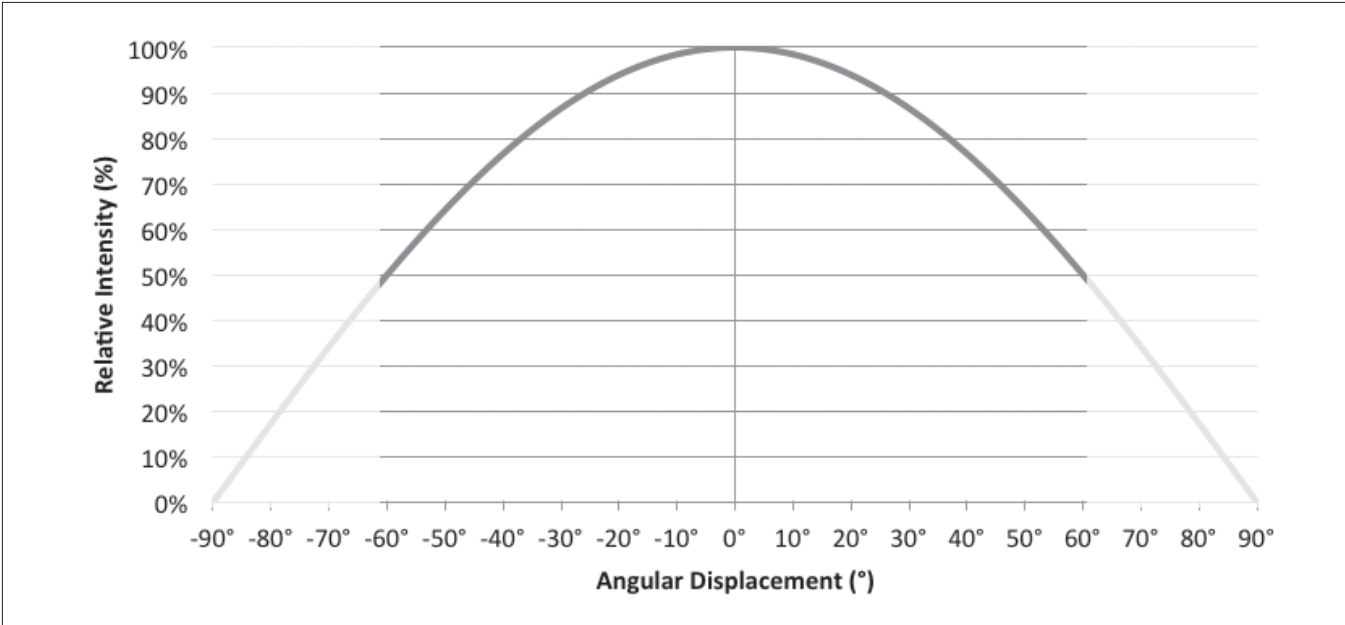

Notes for Figure 9:

- 1. Typical viewing angle is 120°.
- 2. The viewing angle is defined as the off axis angle from the centerline where intensity is 1/2 of the peak value.

Figure 10: Typical Polar Radiation Pattern

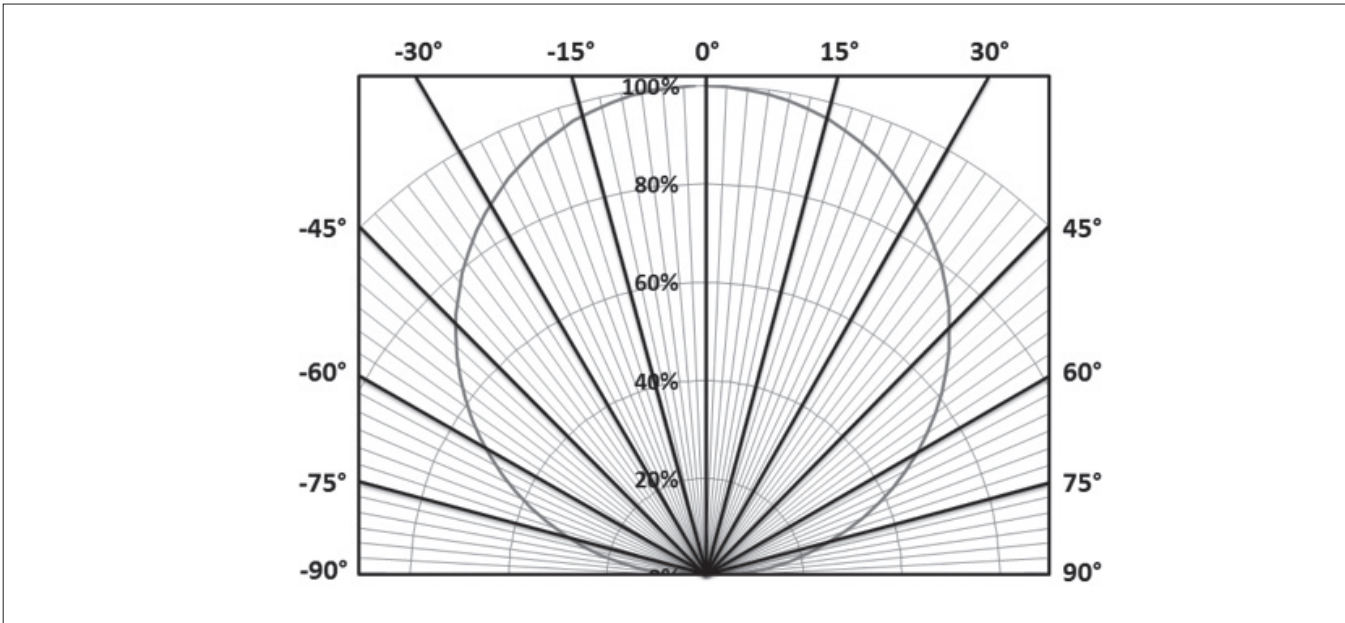



# Typical Color Spectrum

Figure 11: Typical Color Spectrum

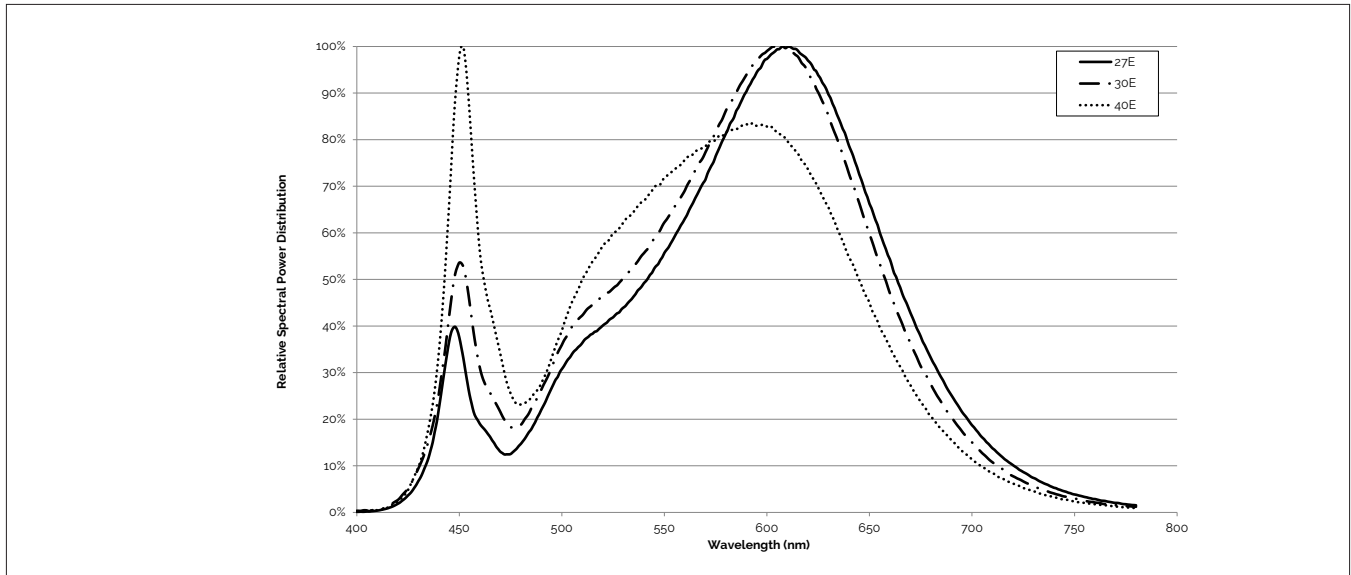

Notes for Figure 11:

1. Color spectra measured at nominal current for  $T_j = T_c = 25^\circ\text{C}$ .
2. Color spectra shown is 2700K and 80 CRI.
3. Color spectra shown is 3000K and 80 CRI.
4. Color spectra shown is 4000K and 80 CRI.

Figure 12: Typical Color Spectrum for Décor Series

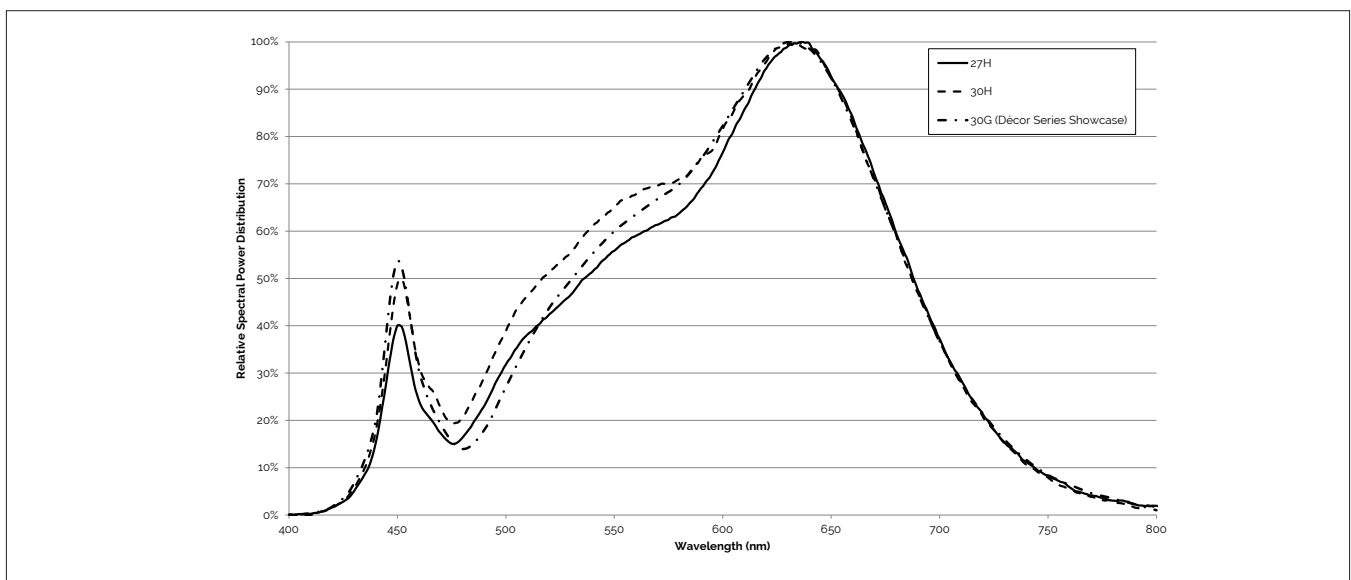

Note for Figure 12:

1. Color spectra measured at nominal current for  $T_j = T_c = 25^\circ\text{C}$ .

# Mechanical Dimensions

**Figure 13: Drawing for V4 HD LED Array**

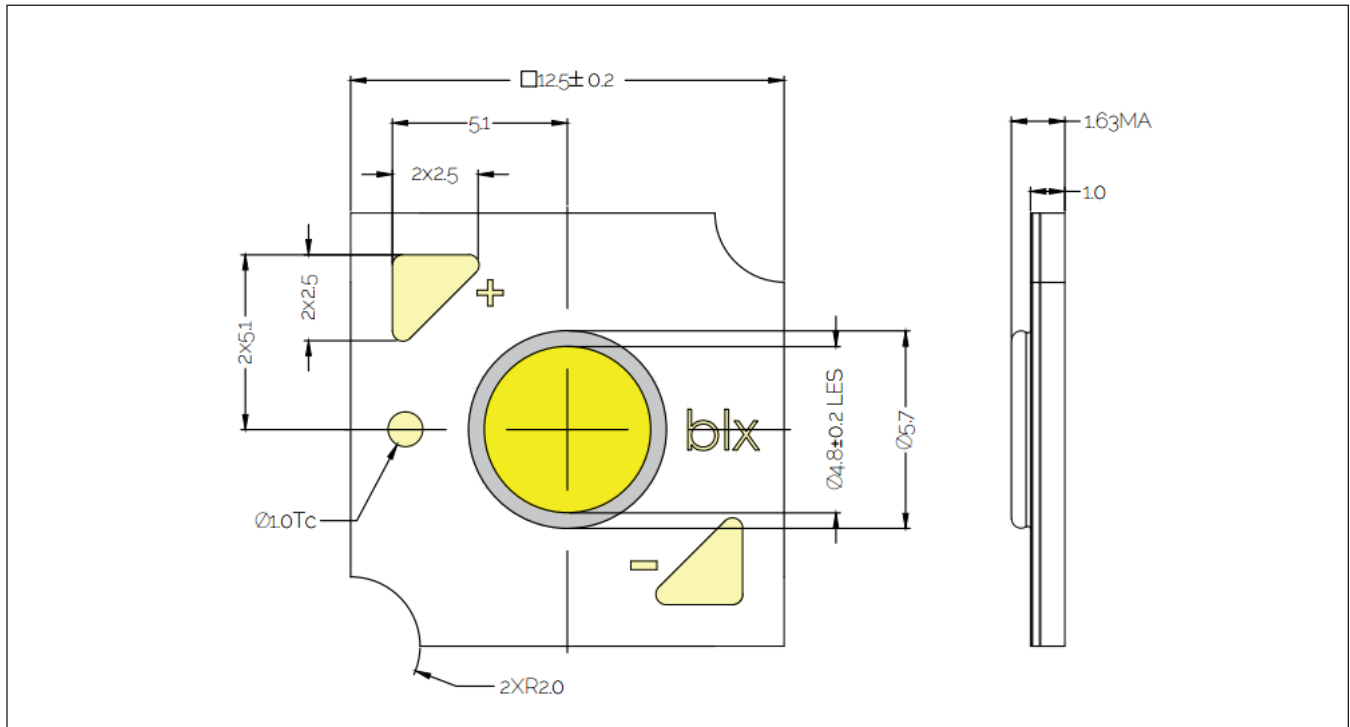

Notes for Figure 13:

1. Drawings are not to scale.
2. Drawing dimensions are in millimeters.
3. Solder pads are labeled "+" and "-" to denote positive and negative polarity, respectively.
4. Unless otherwise specified, tolerances are  $\pm 0.1$  mm.
5. Refer to Application Notes AN101 for product handling, mounting and heat sink recommendations.
6. The optical center of the LED Array is nominally defined by the mechanical center of the array to a tolerance of  $\pm 0.2$  mm.
7. Bridgelux maintains a flatness of  $0.10$  mm across the mounting surface of the array.

# Color Binning Information

**Figure 14: Warm and Neutral White Test Bins in xy Color Space**

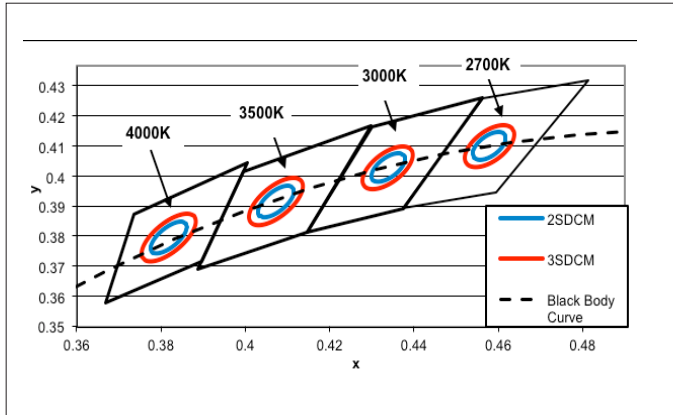

Note: Pulsed Test Conditions,  $T_c = 25^\circ\text{C}$

**Table 7: Warm and Neutral White xy Bin Coordinates and Associated Typical CCT**

Bin Code	2700K	3000K	3500K	4000K
ANSI Bin (for reference only)	(2580K - 2870K)	(2870K - 3220K)	(3220K - 3710K)	(3710K - 4260K)
83 (3 SDCM)	(2651K - 2794K)	(2968K - 3136K)	(3369K - 3586K)	(3851K - 4130K)
82 (2 SDCM)	(2674K - 2769K)	(2995K - 3107K)	(3404K - 3548K)	(3895K - 4081K)
Center Point (x,y)	(0.4578, 0.4101)	(0.4338, 0.403)	(0.4073, 0.3917)	(0.3818, 0.3797)

Note for Table 7:

1. Bridgelux maintains a tolerance of +/- 0.007 on x and y color coordinates in the CIE 1931 color Space.

# Packaging and Labeling

Figure 15: V4 HD Packaging Tube



Notes for Figure 15:

1. Each tube holds 40 V4 HD COB arrays.
2. One tube is sealed in an anti-static bag. Four bags are placed in a shipping box. Depending on quantities ordered, a bigger shipping box, containing four boxes may be used to ship products.
3. Each bag and box is to be labeled as shown above.
4. Dimensions for each tube are 14.3 (W) x 8.3(H) x 530 (L) mm. Dimensions for the anti-static bag are 75 (W) x 615 (L) x 0.075 (T) mm. Dimensions for the shipping box are 58.7 x 13.3 x 7.9 cm

# Packaging and Labeling

**Figure 16: V Series HD Product Labeling**

Bridgelux COB arrays have laser markings on the back side of the substrate to help with product identification. In addition to the product identification markings, Bridgelux COB arrays also contain markings for internal Bridgelux manufacturing use only. The image below shows which markings are for customer use and which ones are for Bridgelux internal use only. The Bridgelux internal manufacturing markings are subject to change without notice, however these will not impact the form, function or performance of the COB array.



# Design Resources

## Application Notes

Bridgelux has developed a comprehensive set of application notes and design resources to assist customers in successfully designing with the V Series product family of LED array products. For all available application notes visit [www.bridgelux.com](http://www.bridgelux.com).

## Optical Source Models

Optical source models and ray set files are available for all Bridgelux products. For a list of available formats, visit [www.bridgelux.com](http://www.bridgelux.com).

## 3D CAD Models

Three dimensional CAD models depicting the product outline of all Bridgelux V Series HD LED arrays are available in both IGS and STEP formats. Please contact your Bridgelux sales representative for assistance.

## LM80

LM80 testing has been completed and the LM80 report is now available. Please contact your Bridgelux sales representatives for LM-80 report.

# Precautions

## CAUTION: CHEMICAL EXPOSURE HAZARD

Exposure to some chemicals commonly used in luminaire manufacturing and assembly can cause damage to the LED array. Please consult Bridgelux Application Note AN101 for additional information.

## CAUTION: RISK OF BURN

Do not touch the V Series HD LED array during operation. Allow the array to cool for a sufficient period of time before handling. The V Series HD LED array may reach elevated temperatures such that could burn skin when touched.

## CAUTION

### CONTACT WITH LIGHT EMITTING SURFACE (LES)

Avoid any contact with the LES. Do not touch the LES of the LED array or apply stress to the LES (yellow phosphor resin area). Contact may cause damage to the LED array.

Optics and reflectors must not be mounted in contact with the LES (yellow phosphor resin area).

# Disclaimers

## MINOR PRODUCT CHANGE POLICY

The rigorous qualification testing on products offered by Bridgelux provides performance assurance. Slight cosmetic changes that do not affect form, fit, or function may occur as Bridgelux continues product optimization.

## STANDARD TEST CONDITIONS

Unless otherwise stated, array testing is performed at the nominal drive current.

# About Bridgelux: Bridging Light and Life™

At Bridgelux, we help companies, industries and people experience the power and possibility of light. Since 2002, we've designed LED solutions that are high performing, energy efficient, cost effective and easy to integrate. Our focus is on light's impact on human behavior, delivering products that create better environments, experiences and returns—both experiential and financial. And our patented technology drives new platforms for commercial and industrial luminaires.

**For more information about the company, please visit**  
**[bridgelux.com](http://bridgelux.com)**  
**[twitter.com/Bridgelux](https://twitter.com/Bridgelux)**  
**[facebook.com/Bridgelux](https://facebook.com/Bridgelux)**  
**[youtube.com/user/Bridgelux](https://youtube.com/user/Bridgelux)**  
**[linkedin.com/company/bridgelux-inc-\\_2](https://linkedin.com/company/bridgelux-inc-_2)**  
**WeChat ID: BridgeluxInChina**



46430 Fremont Boulevard  
Fremont, CA 94538 USA  
Tel (925) 583-8400  
**[www.bridgelux.com](http://www.bridgelux.com)**

© 2021 Bridgelux, Inc. All rights reserved. Product specifications are subject to change without notice. Bridgelux, the Bridgelux stylized logo design, Vero, V Series and V Series HD are registered trademarks, and Decor Series is a trademark of Bridgelux, Inc. All other trademarks are the property of their respective owners.

**Bridgelux V4 HD Array Series Product Data Sheet DS404 Rev. A (05/2021)**

## X-ON Electronics

Largest Supplier of Electrical and Electronic Components

*Click to view similar products for [High Power LEDs - White category](#):*

*Click to view products by [Bridgelux manufacturer](#):*

Other Similar products are found below :

[LTW-K140SZR40](#) [B42180-08](#) [STW8Q2PA-R5-HA](#) [LTPL-P00DWS57](#) [LTW-K140SZR30](#) [LZP-D0WW00-0000](#) [SZ5-M1-WW-C8-V1/V3-FA](#) [LTW-K140SZR57](#) [LTW-K140SZR27](#) [BXRE-50C2001-C-74](#) [MP-5050-8100-27-80](#) [MP-5050-6100-65-80](#) [MP-5050-6100-40-80](#) [MP-5050-6100-30-80](#) [KW DPLS32.SB-6H6J-E5P7-EG-Z264](#) [L1V1-507003V500000](#) [KW CULPM1.TG-Z6RF7-ebvFfcbB46-65G5](#) [KW DMLS33.SG-Z6M7-EBVFFCBB46-8E8G-700-S](#) [KW DPLS33.KD-HIJG-D30D144-HN-22C2-120-S](#) [KW DDLM31.EH-5J6K-A737-W4A4-140-R18](#) [GW JTLRS1.CM-K1LW-XX57-1-100-Q-R33](#) [KW DDLM31.EH-5J6K-A636-W4A4-140-R18](#) [KW DDLM31.EH-5J6K-A131-W4A4-140-R18](#) [SML-LXL8047MWCTR/3](#) [L2C5-40HG1203E0900](#) [JB3030AWT-P-U27EA0000-N0000001](#) [JK3030AWT-P-U30EA0000-N0000001](#) [JK3030AWT-P-B40EB0000-N0000001](#) [JK3030AWT-P-H30EB0000-N0000001](#) [JK3030AWT-P-H40EB0000-N0000001](#) [JK3030AWT-P-U27EB0000-N0000001](#) [JK3030AWT-P-U30EB0000-N0000001](#) [GW PUSTA1.PM-PAPC-XX53-1-1050-R18](#) [BXRE-30E4000-C-83](#) [BXRE-50C6501-D-84](#) [BXRE-27E1000-B-83](#) [BXRE-30G0800-D-83](#) [BXRE-50C4001-B-84](#) [BXRE-50C6501-C-84](#) [BXRH-40E4000-F-83](#) [BXRH-27G4000-F-83](#) [BXRE-27G30H0-D-82](#) [BXRE-27G4000-B-83](#) [BXRE-40E1000-B-83](#) [BXRE-40E6500-D-83](#) [BXRH-27E1000-B-83](#) [BXRH-27E1000-G-83](#) [BXRH-27E4000-F-83](#) [BXRH-27G1000-B-83](#) [BXRH-30E0600-A-83](#)