



Bridgelux® V6 HD Thrive™ Array

Product Data Sheet DS406



BXRH-27S | 30S | 35S | 40S | 50S | 57S | 65S

Introduction

V6 HD Thrive



Bridgelux Thrive™ combines unique chip, phosphor and packaging technology to closely match the spectra of natural light over the visible wavelength range. Thrive can be used in constant color point luminaires to bring full spectrum natural light indoors or in tunable white luminaires to incorporate circadian elements that may impact human well-being. The high fidelity spectral output of Thrive creates stunning environments with excellent color rendering and outstanding TM30 metrics. Thrive is available in both SMD components and LED arrays to enable a broad range of lighting applications including retail, hospitality, office, education, architectural, museums, healthcare and residential lighting.

Features

- Engineered spectrum to closely match natural light
- CRI >95, R1-R15 >90, high Rf and Rg values
- High efficacy full spectrum solution
- No violet chip augmentation
- Hot color targeted
- Form factor consistent with existing Bridgelux COB arrays
- Broad product platform availability (SMDs and COBs)

Benefits

- Full consistent spectrum with fewer spectral spikes
- Natural and vivid color rendering
- Greater energy savings, lower utility costs
- Economical, high efficiency solution
- Uniform and consistent white light at application conditions
- Ease of design and rapid go-to-market
- Enables greater design flexibility and platform color consistency



Contents

Product Feature Map	2
Product Nomenclature	2
Product Selection Guide	3
Spectrum Characteristics	6
Electrical Characteristics	9
Absolute Maximum Ratings	10
Eye Safety	11
Product Bin Definitions	12
Performance Curves	13
Typical Radiation Pattern	15
Mechanical Dimensions	16
Packaging and Labeling	17
Design Resources	19
Precautions	19
Disclaimers	19
About Bridgelux	20

Product Feature Map

Bridgelux arrays are fully engineered devices that provide consistent thermal and optical performance on an engineered mechanical platform. The V Series HD arrays are the most compact chip-on-board devices across all of Bridgelux's LED Array products. The arrays incorporate several features to simplify design integration and assembly. Please visit www.bridgelux.com for more information on the V Series HD family of products.

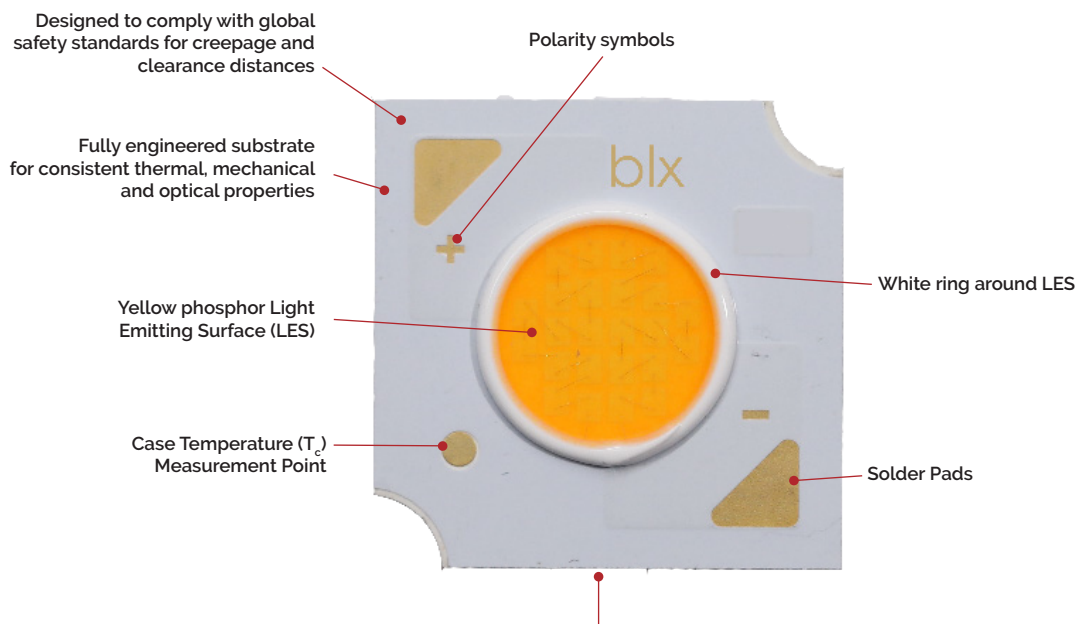

Note: Part number and lot codes are scribed on back of array

Product Nomenclature

The part number designation for Bridgelux COB arrays is explained as follows:

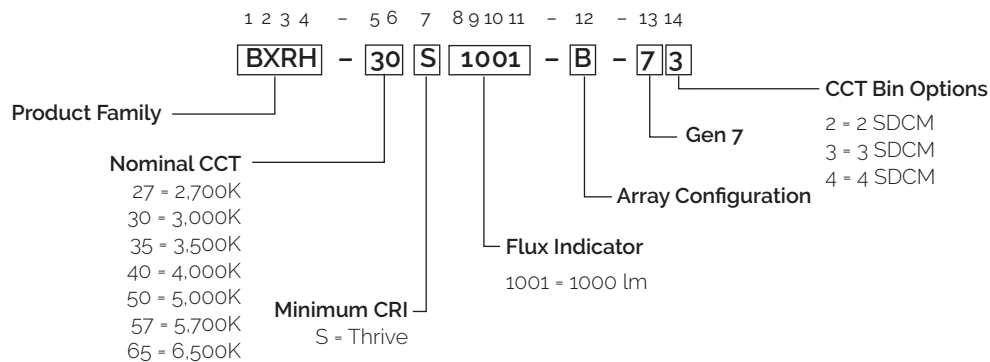

Product Selection Guide

The following product configurations are available:

Table 1: Selection Guide, Pulsed Measurement Data ($T_c = 25^\circ\text{C}$)

Part Number ^{1,6}	Nominal CCT ¹ (K)	CRI ²	Nominal Drive Current ³ (mA)	Typical V_f (V)	Typical Pulsed Flux ^{4,5,6,7} $T_c = 25^\circ\text{C}$ (lm)	Minimum Pulsed Flux ^{6,7,8} $T_c = 25^\circ\text{C}$ (lm)	Typical Power (W)	Typical Efficacy (lm/W)
BXRH-27S1001-B-7X	2700	98	350	36.4	1147	1009	12.7	90
BXRH-27S1001-G-7X	2700	98	700	18.2	1147	1009	12.7	90
BXRH-30S1001-B-7X	3000	98	350	36.4	1223	1076	12.7	96
BXRH-30S1001-G-7X	3000	98	700	18.2	1223	1076	12.7	96
BXRH-35S1001-B-7X	3500	98	350	36.4	1287	1132	12.7	101
BXRH-35S1001-G-7X	3500	98	700	18.2	1287	1132	12.7	101
BXRH-40S1001-B-7X	4000	98	350	36.4	1338	1177	12.7	105
BXRH-40S1001-G-7X	4000	98	700	18.2	1338	1177	12.7	105
BXRH-50S1001-B-7X	5000	98	350	36.4	1401	1233	12.7	110
BXRH-50S1001-G-7X	5000	98	700	18.2	1401	1233	12.7	110
BXRH-57S1001-B-7X	5700	98	350	36.4	1401	1233	12.7	110
BXRH-57S1001-G-7X	5700	98	700	18.2	1401	1233	12.7	110
BXRH-65S1001-B-7X	6500	98	350	36.4	1414	1244	12.7	111
BXRH-65S1001-G-7X	6500	98	700	18.2	1414	1244	12.7	111

Table 2: Selection Guide, Stabilized DC Test Performance ($T_c = 85^\circ\text{C}$)^{4,5,6}

Part Number ^{1,6}	Nominal CCT ¹ (K)	CRI ²	Nominal Drive Current ³ (mA)	Typical V_f (V)	Typical DC Flux ^{4,5,6,7} $T_c = 85^\circ\text{C}$ (lm)	Minimum DC Flux ^{6,7,8,9} $T_c = 85^\circ\text{C}$ (lm)	Typical Power (W)	Typical Efficacy (lm/W)
BXRE-27S1001-B-7x	2700	98	350	35.4	1032	908	12.4	83
BXRE-27S1001-C-7x	2700	98	700	17.7	1032	908	12.4	83
BXRE-30S1001-B-7x	3000	98	350	35.4	1101	969	12.4	89
BXRE-30S1001-C-7x	3000	98	700	17.7	1101	969	12.4	89
BXRE-35S1001-B-7x	3500	98	350	35.4	1158	1019	12.4	93
BXRE-35S1001-C-7x	3500	98	700	17.7	1158	1019	12.4	93
BXRE-40S1001-B-7x	4000	98	350	35.4	1204	1059	12.4	97
BXRE-40S1001-C-7x	4000	98	700	17.7	1204	1059	12.4	97
BXRE-50S1001-B-74	5000	98	350	35.4	1261	1110	12.4	102
BXRE-50S1001-C-74	5000	98	700	17.7	1261	1110	12.4	102
BXRE-57S1001-B-74	5700	98	350	35.4	1261	1110	12.4	102
BXRE-57S1001-C-74	5700	98	700	17.7	1261	1110	12.4	102
BXRE-65S1001-B-74	6500	98	350	35.4	1273	1120	12.4	103
BXRE-65S1001-C-74	6500	98	700	17.7	1273	1120	12.4	103

Notes for Table 1 & 2:

- Product CCT is hot targeted at $T_j = 85^\circ\text{C}$. Nominal CCT as defined by ANSI C78.377-2011.
- All CRI values are measured at $T_j = T_c = 85^\circ\text{C}$. CRI values are typical values. Minimum CRI for Thrive products is 95. Bridgelux maintains a ± 3 tolerance on CRI values.
- Drive current is referred to as nominal drive current.
- Products tested under pulsed condition (10ms pulse width) at nominal test current where T_j (junction temperature) - T_c (case temperature) = 25°C . Typical stabilized DC performance values are provided as reference only and are not a guarantee of performance.
- Typical performance values are provided as a reference only and are not a guarantee of performance.
- Typical performance is estimated based on operation under DC (direct current) with LED array mounted onto a heat sink with thermal interface material and the case temperature maintained at 85°C . Based on Bridgelux test setup, values may vary depending on the thermal design of the luminaire and/or the exposed environment to which the product is subjected.
- Bridgelux maintains a $\pm 7\%$ tolerance on flux measurements.
- Minimum flux values at the nominal test current are guaranteed by 100% test.
- Minimum flux values at elevated temperatures are provided for reference only and are not guaranteed by 100% production testing. Based on Bridgelux test setup, values may vary depending on the thermal design of the luminaire and/or the exposed environment to which the product is subjected.

Performance at Commonly Used Drive Currents

V Series HD Thrive LED arrays are tested to the specifications shown using the nominal drive currents in Table 1. V Series HD Thrive LED Arrays may also be driven at other drive currents dependent on specific application design requirements. The performance at any drive current can be derived from the current vs. voltage characteristics shown in Figures 10 & 11 and the flux vs. current characteristics shown in Figures 12 & 13. The performance at commonly used drive currents is summarized in Table 3.

Table 3: Product Performance at Commonly Used Drive Currents

Part Number	CRI	Drive Current ¹ (mA)	Typical V _f T _c = 25°C (V)	Typical Power T _c = 25°C (W)	Typical Flux ² T _c = 25°C (lm)	Typical DC Flux ³ T _c = 85°C (lm)	Typical Efficacy T _c = 25°C (lm/W)
BXRH-27S1001-B-7x	98	175	34.2	6.0	618	556	103
		250	35.2	8.8	854	769	97
		350	36.4	12.7	1147	1032	90
		440	37.3	16.4	1395	1255	85
		480	37.7	18.1	1499	1349	83
BXRH-27S1001-G-7x	98	350	17.1	6.0	618	556	103
		500	17.6	8.8	854	769	97
		700	18.2	12.7	1147	1032	90
		880	18.7	16.4	1395	1255	85
		960	18.9	18.1	1499	1349	83
BXRH-30S1001-B-7x	98	175	34.2	6.0	659	593	110
		250	35.2	8.8	911	820	104
		350	36.4	12.7	1223	1101	96
		440	37.3	16.4	1487	1338	91
		480	37.7	18.1	1598	1438	88
BXRH-30S1001-G-7x	98	350	17.1	6.0	659	593	110
		500	17.6	8.8	911	820	103
		700	18.2	12.7	1223	1101	96
		880	18.7	16.4	1487	1338	90
		960	18.9	18.1	1598	1438	88
BXRH-35S1001-B-7x	98	175	34.2	6.0	694	624	116
		250	35.2	8.8	958	863	109
		350	36.4	12.7	1287	1158	101
		440	37.3	16.4	1565	1408	95
		480	37.7	18.1	1682	1513	93
BXRH-35S1001-G-7x	98	350	17.1	6.0	694	624	116
		500	17.6	8.8	958	863	109
		700	18.2	12.7	1287	1158	101
		880	18.7	16.4	1565	1408	95
		960	18.9	18.1	1682	1513	93
BXRH-40S1001-B-7x	98	175	34.2	6.0	721	649	121
		250	35.2	8.8	996	897	113
		350	36.4	12.7	1338	1204	105
		440	37.3	16.4	1627	1464	99
		480	37.7	18.1	1748	1573	97
BXRH-40S1001-G-7x	98	350	17.1	6.0	721	649	120
		500	17.6	8.8	996	897	113
		700	18.2	12.7	1338	1204	105
		880	18.7	16.4	1627	1464	99
		960	18.9	18.1	1748	1573	96

Notes for Table 3:

1. Alternate drive currents are provided for reference only and are not a guarantee of performance.
2. Bridgelux maintains a ± 7% tolerance on flux measurements.
3. Typical stabilized DC performance values are provided as reference only and are not a guarantee of performance.

Performance at Commonly Used Drive Currents

Table 3: Product Performance at Commonly Used Drive Currents (Continued)

Part Number	CRI	Drive Current ¹ (mA)	Typical V _f T _c = 25°C (V)	Typical Power T _c = 25°C (W)	Typical Flux ² T _c = 25°C (lm)	Typical DC Flux ³ T _c = 85°C (lm)	Typical Efficacy T _c = 25°C (lm/W)
BXRH-50S1001-B-7x	98	175	34.2	6.0	755	680	126
		250	35.2	8.8	1043	939	119
		350	36.4	12.7	1401	1261	110
		440	37.3	16.4	1703	1533	104
		480	37.7	18.1	1831	1648	101
BXRH-50S1001-G-7x	98	350	17.1	6.0	755	680	126
		500	17.6	8.8	1043	939	118
		700	18.2	12.7	1401	1261	110
		880	18.7	16.4	1703	1533	104
		960	18.9	18.1	1831	1648	101
BXRH-57S1001-B-7x	98	175	34.2	6.0	755	680	126
		250	35.2	8.8	1043	939	119
		350	36.4	12.7	1401	1261	110
		440	37.3	16.4	1703	1533	104
		480	37.7	18.1	1831	1648	101
BXRH-57S1001-G-7x	98	350	17.1	6.0	755	680	126
		500	17.6	8.8	1043	939	118
		700	18.2	12.7	1401	1261	110
		880	18.7	16.4	1703	1533	104
		960	18.9	18.1	1831	1648	101
BXRH-65S1001-B-7x	98	175	34.2	6.0	762	686	127
		250	35.2	8.8	1053	948	120
		350	36.4	12.7	1414	1273	111
		440	37.3	16.4	1719	1547	105
		480	37.7	18.1	1848	1663	102
BXRH-65S1001-G-7x	98	350	17.1	6.0	762	686	127
		500	17.6	8.8	1053	948	120
		700	18.2	12.7	1414	1273	111
		880	18.7	16.4	1719	1547	105
		960	18.9	18.1	1848	1663	102

Notes for Table 3:

1. Alternate drive currents are provided for reference only and are not a guarantee of performance.
2. Bridgelux maintains a ± 7% tolerance on flux measurements.
3. Typical stabilized DC performance values are provided as reference only and are not a guarantee of performance.

Spectrum Characteristics

Table 4: Typical Color Rendering Index and TM-30 Values at, $T_c=85^\circ\text{C}$

Nominal CCT ¹	R _f	R _g	R ₁	R ₂	R ₃	R ₄	R ₅	R ₆	R ₇	R ₈	R ₉	R ₁₀	R ₁₁	R ₁₂	R ₁₃	R ₁₄	R ₁₅
2700K	95	103	97	99	94	94	97	98	97	98	99	97	91	98	98	95	98
3000K	95	104	98	99	93	94	97	98	96	96	97	96	92	95	98	95	97
3500K	95	98	98	98	97	98	98	98	98	97	93	97	97	95	98	97	98
4000K	97	100	99	99	97	99	99	99	99	98	94	97	99	96	99	98	98
5000K	97	100	98	99	98	98	98	98	99	98	95	98	98	98	98	98	97
5700K	94	98	98	98	97	95	98	97	96	95	92	97	96	96	98	98	97
6500K	95	98	98	98	97	96	98	98	96	96	93	97	96	97	98	98	97

Note for Table 4:

1. Bridgelux maintains a tolerance of ± 3 on Color Rendering Index R1-R15 measurements and TM-30 measurements.

Figure 1: 2700K Thrive TM-30 Graphs

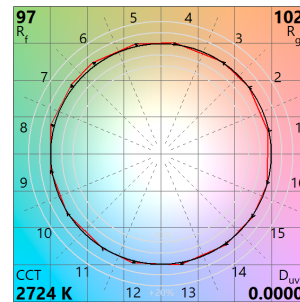
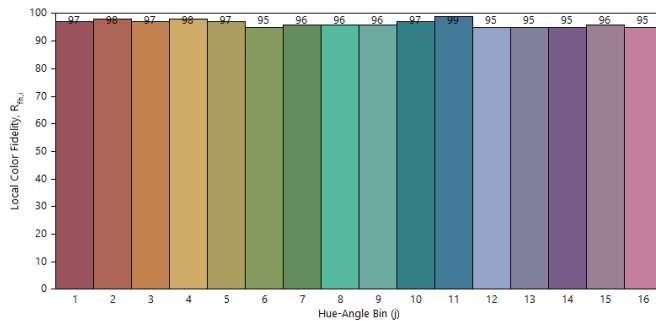

Figure 2: 3000K Thrive TM-30 Graphs

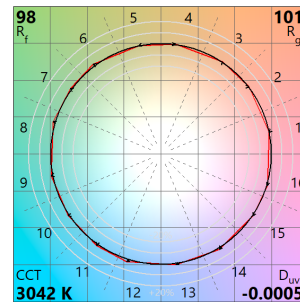
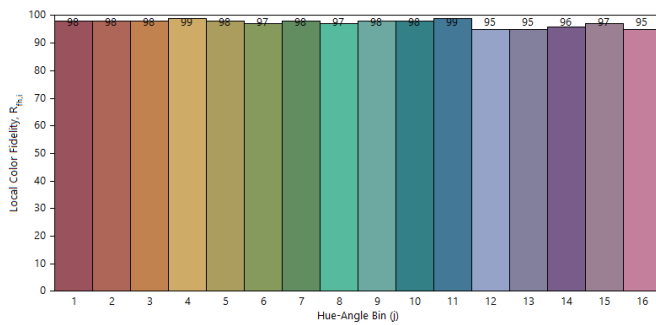
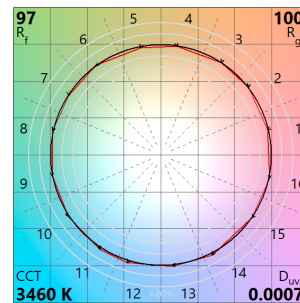
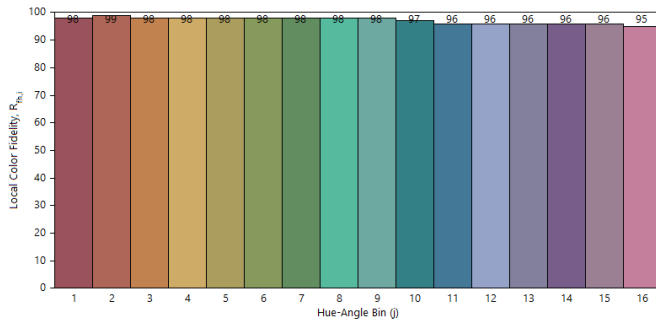

Figure 3: 3500K Thrive TM-30 Graphs



Spectrum Characteristics

Figure 4: 4000K Thrive TM-30 Graphs

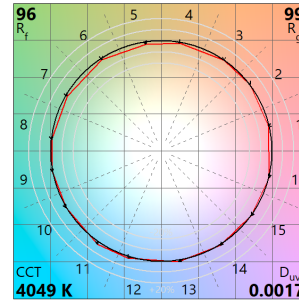
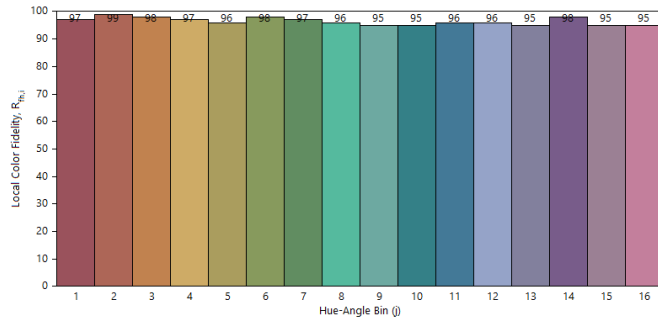

Figure 5: 5000K Thrive TM-30 Graphs

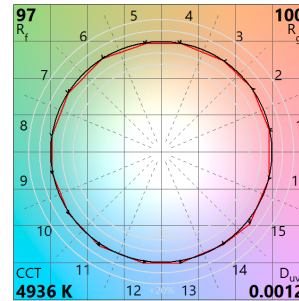
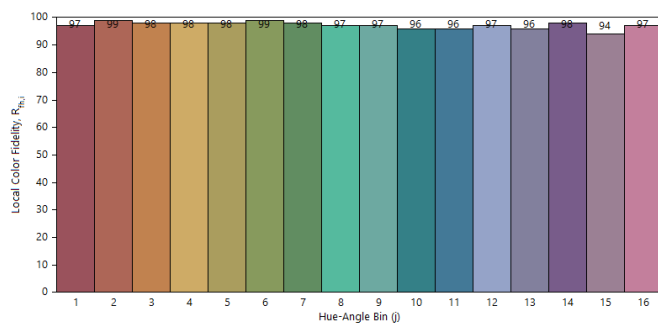

Figure 6: 5700K Thrive TM30 Graphs

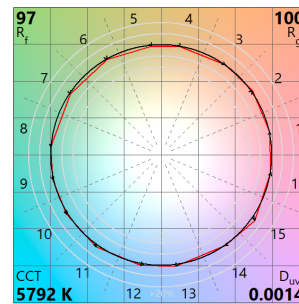
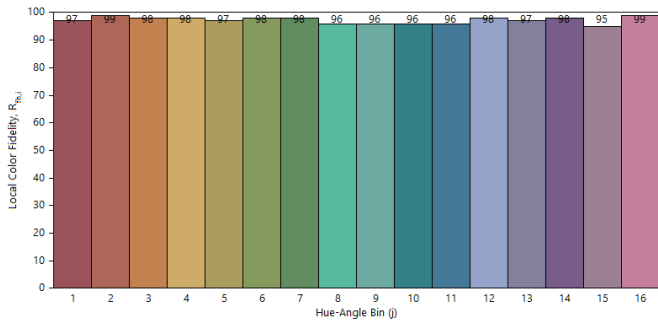
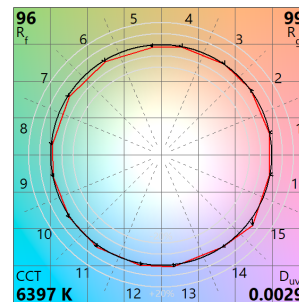
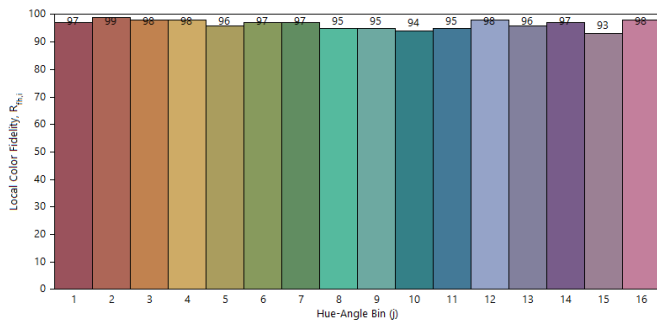
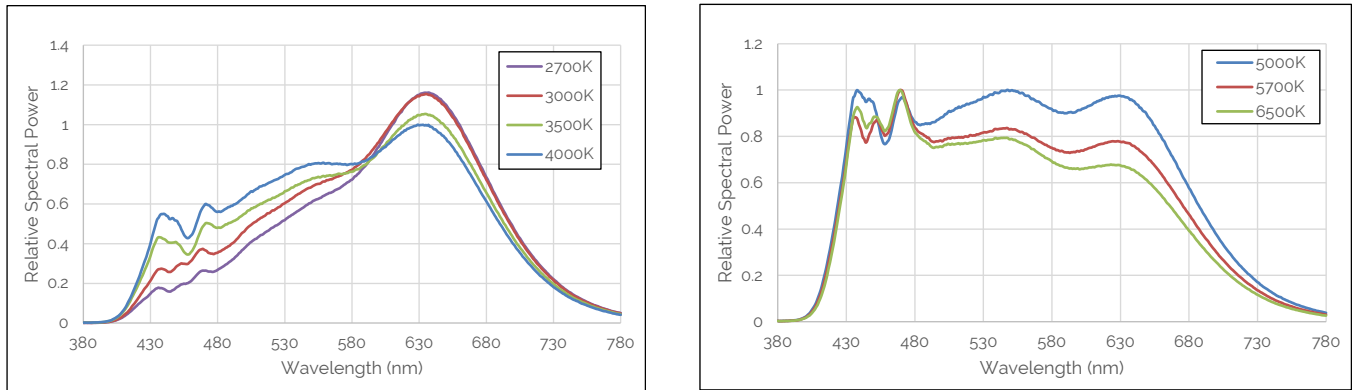

Figure 7: 6500K Thrive TM-30 Graphs



Spectrum Characteristics

Figure 8: Typical Color Spectrum



Note for Figure 8:

1. Color spectra measured at nominal current for $T_c = 85^\circ\text{C}$.

Spectral Matching to Natural Light

The lighting market is in the early stages of adoption of human-centric lighting (HCL). HCL encompasses the effects of lighting on the physical and emotional health and well-being of people. Throughout evolution, the human visual system has evolved under the natural light of sun and fire. These light sources have standardized industry spectral power definitions that describe the state of natural light. However, conventional metrics such as CCT, CRI, and TM-30 fail to adequately quantify the naturalness, or closeness of these light sources to the standardized natural spectra. Due to a lack of an industry standard metric to quantitatively measure the naturalness of a light source, Bridgelux has pioneered a new metric that takes the guesswork out of comparing LED light sources to natural light.

Average Spectral Difference, or ASD, is calculated by measuring the absolute difference between two spectra at discrete wavelengths. These values are averaged across a wavelength range derived from the photopic response curve, or $V(\lambda)$; a luminous efficiency function describing the average spectral sensitivity of human perception of brightness. The range of 425nm to 690nm was selected to remove the tails of the $V(\lambda)$ gaussian distribution below 1% of the peak value at 555nm, covering 99.9% of the area under the photopic response curve. Natural light is defined following the approach of IES TM-30; black body curves for light sources of $\leq 4000\text{K}$ and the CIE standard illuminant D for light sources of $\geq 5000\text{K}$.

Natural light has an ASD of 0%; lower ASD values indicate a closer match to natural light. Thrive is engineered to provide the closest match to natural light available using proprietary chip, phosphor and packaging technology, resulting in an ASD between 8% to 10% for all CCTs. By comparison, standard 80, 90, and 98 CRI light sources have ASD values that are 100% to 300% larger than Thrive. To learn more about the ASD metric, please review the Bridgelux whitepaper: Average Spectral Difference, a new method to make objective comparisons of naturalness between light sources; or contact your Bridgelux sales representative.

Table 5: Typical ASD Values at $T_c = 85^\circ\text{C}$.

Nominal CCT ¹	ASD
2700K	10%
3000K	9%
3500K	8%
4000K	8%
5000K	9%
5700K	9%
6500K	8%

Figure 9: SPD Comparison

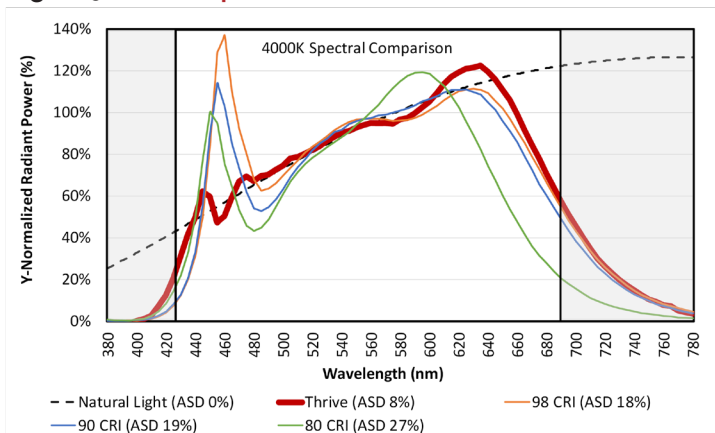

Electrical Characteristics

Table 6: Electrical Characteristics

Part Number	Drive Current (mA)	Forward Voltage Pulsed, $T_c = 25^\circ\text{C}$ (V) ^{1, 2, 3, 8}			Typical Coefficient of Forward Voltage ⁴ $\Delta V_f / \Delta T_c$ (mV/ $^\circ\text{C}$)	Typical Thermal Resistance Junction to Case ^{5,6} R_{j-c} ($^\circ\text{C}/\text{W}$)	Driver Selection Voltages ⁷ (V)	
		Minimum	Typical	Maximum			V_f Min. Hot $T_c = 105^\circ\text{C}$ (V)	V_f Max. Cold $T_c = -40^\circ\text{C}$ (V)
BXRH-xxx100x-B-73	350	34.1	36.4	39.1	-16.2	0.36	32.8	40.2
	480	35.2	37.7	40.4	-16.2	0.39	33.9	41.5
BXRH-xxx100x-G-73	700	17.0	18.2	19.6	-8.1	0.36	16.4	20.1
	960	17.6	18.7	20.2	-8.1	0.39	16.9	20.8

Notes for Table 6:

- Parts are tested in pulsed conditions, $T_c = 25^\circ\text{C}$. Pulse width is 10ms.
- Voltage minimum and maximum are provided for reference only and are not a guarantee of performance.
- Bridgelux maintains a tester tolerance of $\pm 0.10\text{V}$ on forward voltage measurements.
- Typical coefficient of forward voltage tolerance is $\pm 0.1\text{mV}$ for nominal current.
- Thermal resistance values are based from test data of a 3000K 80 CRI product.
- Thermal resistance value was calculated using total electrical input power; optical power was not subtracted from input power. The thermal interface material used during testing is not included in the thermal resistance value.
- V_f min hot and max cold values are provided as reference only and are not guaranteed by test. These values are provided to aid in driver design and selection over the operating range of the product.
- This product has been designed and manufactured per IEC 62031:2014. This product has passed dielectric withstand voltage testing at 500 V. The working voltage designated for the insulation is 50V d.c. The maximum allowable voltage across the array must be determined in the end product application.

Absolute Maximum Ratings

Table 7: Maximum Ratings

Parameter	Maximum Rating	
LED Junction Temperature (T_j)	125°C	
Storage Temperature	-40°C to +105°C	
Operating Case Temperature ¹ (T_c)	105°C	
Soldering Temperature ²	300°C or lower for a maximum of 6 seconds	
	BXRH-xxx100x-B-7x	BXRH-xxx100x-G-7x
Maximum Drive Current ³	480mA	960mA
Maximum Peak Pulsed Drive Current ⁴	680mA	1360mA
Maximum Reverse Voltage ⁵	-60V	-30V

Notes for Table 7:

1. For IEC 62717 requirement, please consult your Bridgelux sales representative.
2. Refer to Bridgelux Application Note AN101: Handling and Assembly of Bridgelux V Series LED Arrays.
3. Arrays may be driven at higher currents however lumen maintenance may be reduced, and product warranty will be void.
4. Bridgelux recommends a maximum duty cycle of 10% and pulse width of 20 ms when operating LED Arrays at maximum peak pulsed current specified. Maximum peak pulsed currents indicate values where LED Arrays can be driven without catastrophic failures.
5. Light emitting diodes are not designed to be driven in reverse voltage and will not produce light under this condition. Maximum rating provided for reference only.

Eye Safety

Table 8: Eye Safety Risk Group (RG) Classifications

Part Number	Drive Current ³ (mA)	CCT ^{1,3}	
		2700K/3000K	4000K ²
BXRH-xxx100x-B-73	350	RG1	RG2
	480	RG1	RG2
BXRH-xxx100x-G-73	700	RG1	RG2
	960	RG1	RG2

Notes for Table 8:

1. Eye safety classification for the use of Bridgelux V Series HD LED arrays is in accordance with specification IEC/TR 62778: Application of IEC 62471 for the assessment of blue light hazard to light sources and luminaires.
2. For products classified as RG2 at 4000K, E_{thr} = 1760 lx.
3. Please contact your Bridgelux sales representative for E_{thr} values at specific drive currents and CCTs not listed.

Product Bin Definitions

Table 9: 2-, 3- and 4-step MacAdam Ellipse Color Bin Definitions

CCT	Center Point		Degree	2-step		3-step		4-step	
	x	y	(°)	a	b	a	b	a	b
2700K	0.4578	0.4101	53.700	0.00540	0.00280	0.0081	0.0042	N/A	N/A
3000K	0.4338	0.403	53.217	0.00556	0.00272	0.0083	0.0041	N/A	N/A
4000K	0.3818	0.3797	53.717	0.00626	0.00268	0.0094	0.0040	N/A	N/A
5000K	0.3447	0.3553	59.617	N/A	N/A	0.0082	0.0035	0.0110	0.0047
5700K	0.3287	0.3417	59.060	N/A	N/A	0.0074	0.0032	0.0099	0.0042
6500K	0.3123	0.3282	58.567	N/A	N/A	0.0066	0.0028	0.0090	0.0038

Notes for Table 9:

1. Color binning at $T_c=85^\circ\text{C}$
2. Bridgelux maintains a tolerance of ± 0.007 on x and y color coordinates in the CIE 1931 color space.

Figure 10: C.I.E. 1931 Chromaticity Diagram (Color targeted at $T_c=85^\circ\text{C}$)

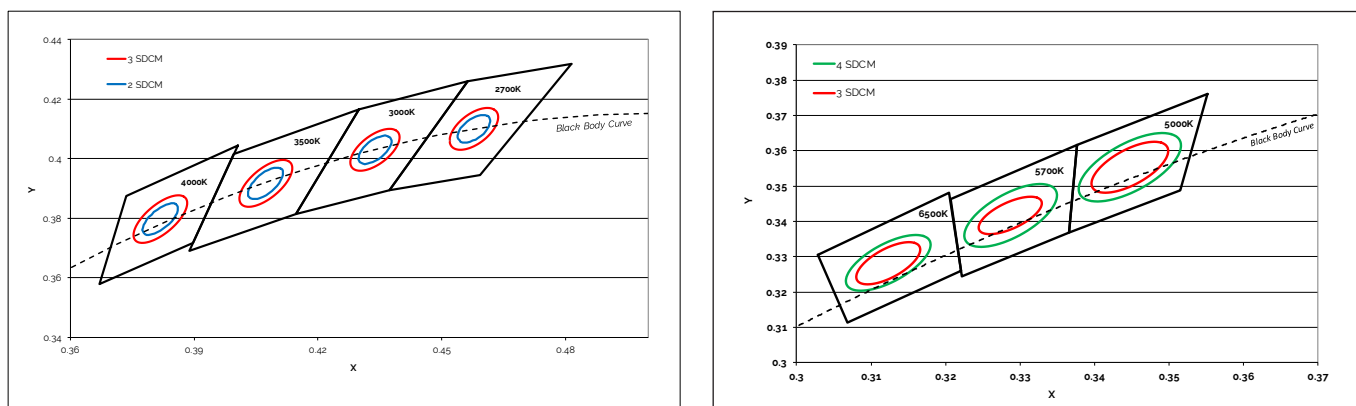

Performance Curves

Figure 11: Drive Current vs. Voltage V6B HD²

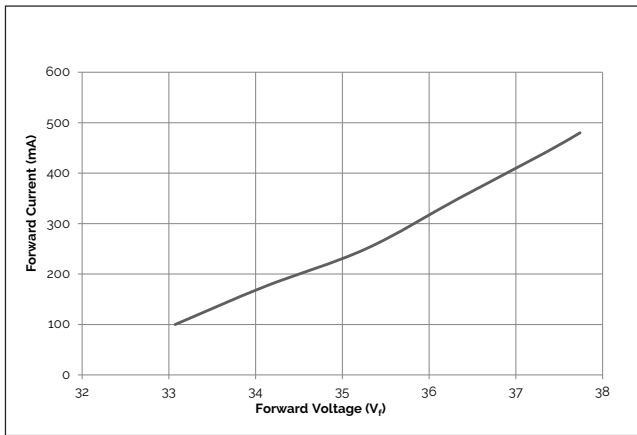

Figure 12: Drive Current vs. Voltage V6G HD²

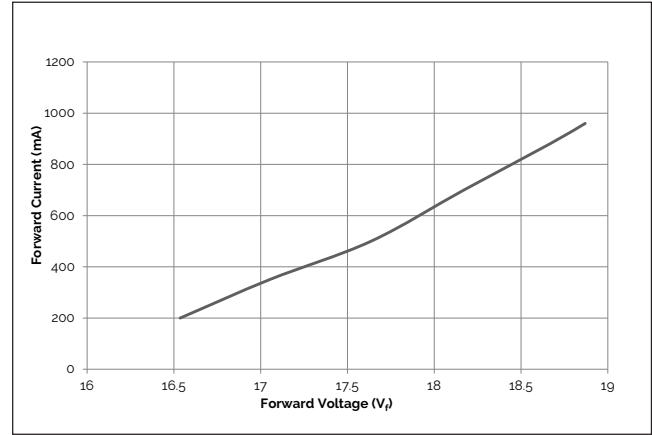

Figure 13: Typical Relative Flux vs. Current V6B HD^{1,2}

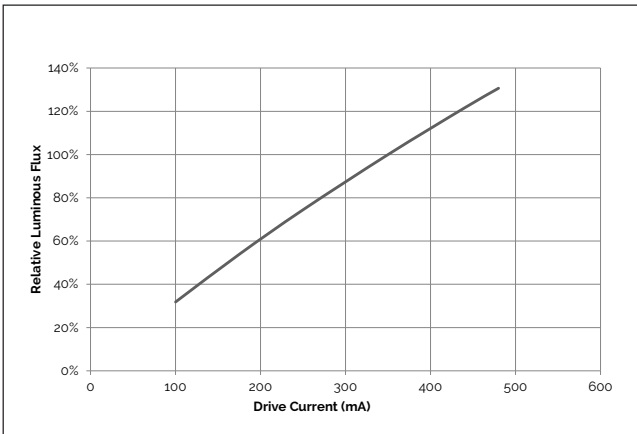
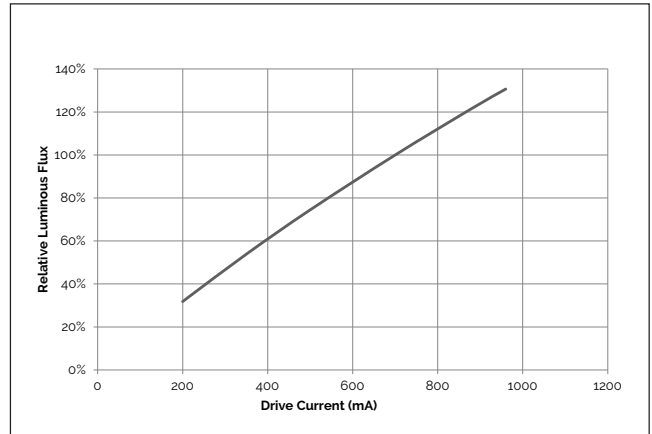

Figure 14: Typical Relative Flux vs. Current V6G HD^{1,2}



Performance Curves

Figure 15: Typical DC Flux vs. Case Temperature

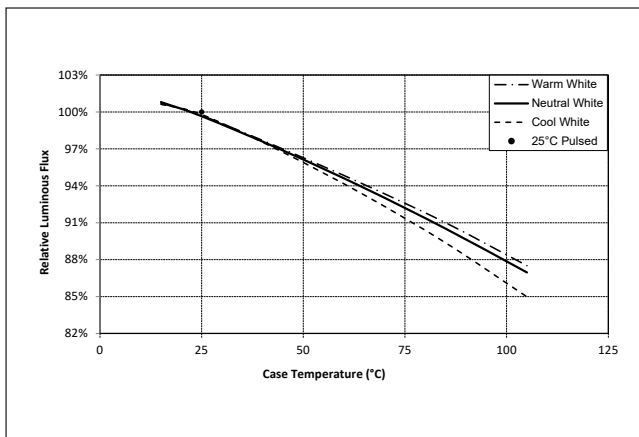

Figure 16: Typical ccx Shift vs. Case Temperature

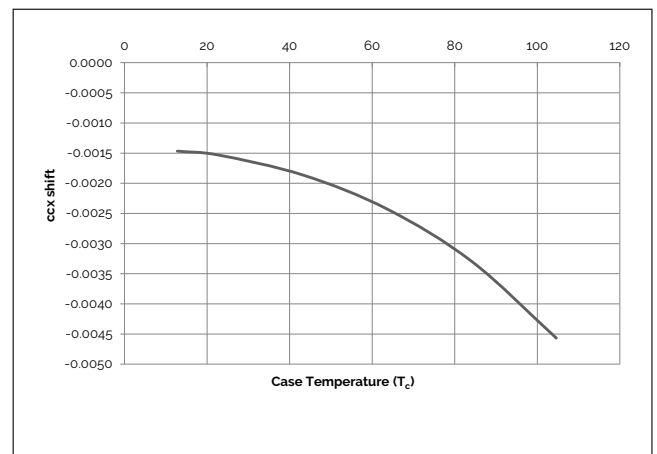
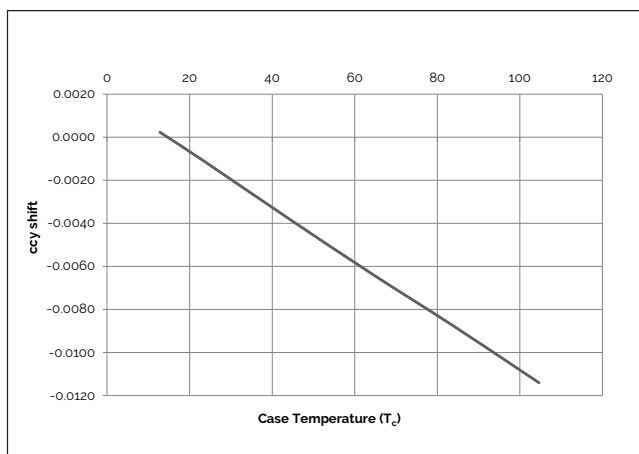

Figure 17: Typical ccy Shift vs. Case Temperature



Notes for Figures 15-17:

1. Bridgelux does not recommend driving high power LEDs at low currents. Doing so may produce unpredictable results. Pulse width modulation (PWM) is recommended for dimming effects.
2. Characteristics shown for warm white based on 3000K Thrive
3. Characteristics shown for neutral white based on 4000K Thrive
4. Characteristics shown for cool white based on 5000K Thrive
5. For other color SKUs, the shift in color will vary. Please contact your Bridgelux Sales Representative for more information.

Typical Radiation Pattern

Figure 18: Typical Spatial Radiation Pattern

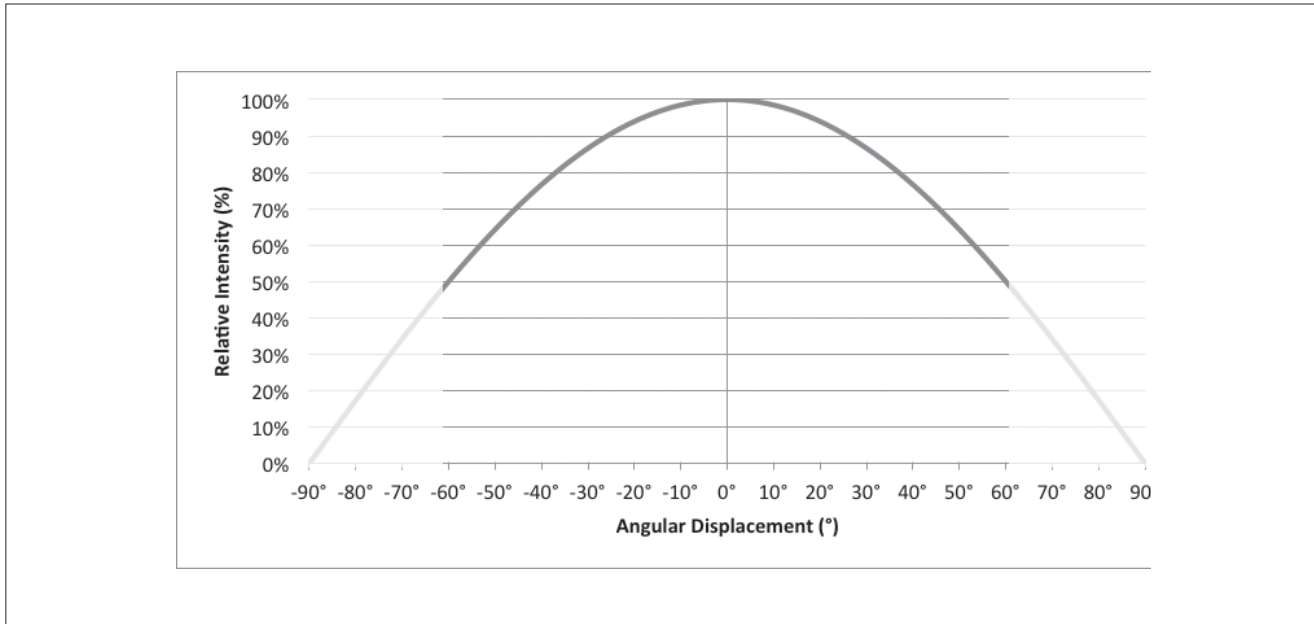

Notes for Figure 18:

1. Typical viewing angle is 120° .
2. The viewing angle is defined as the off axis angle from the centerline where intensity is $\frac{1}{2}$ of the peak value.

Figure 19: Typical Polar Radiation Pattern

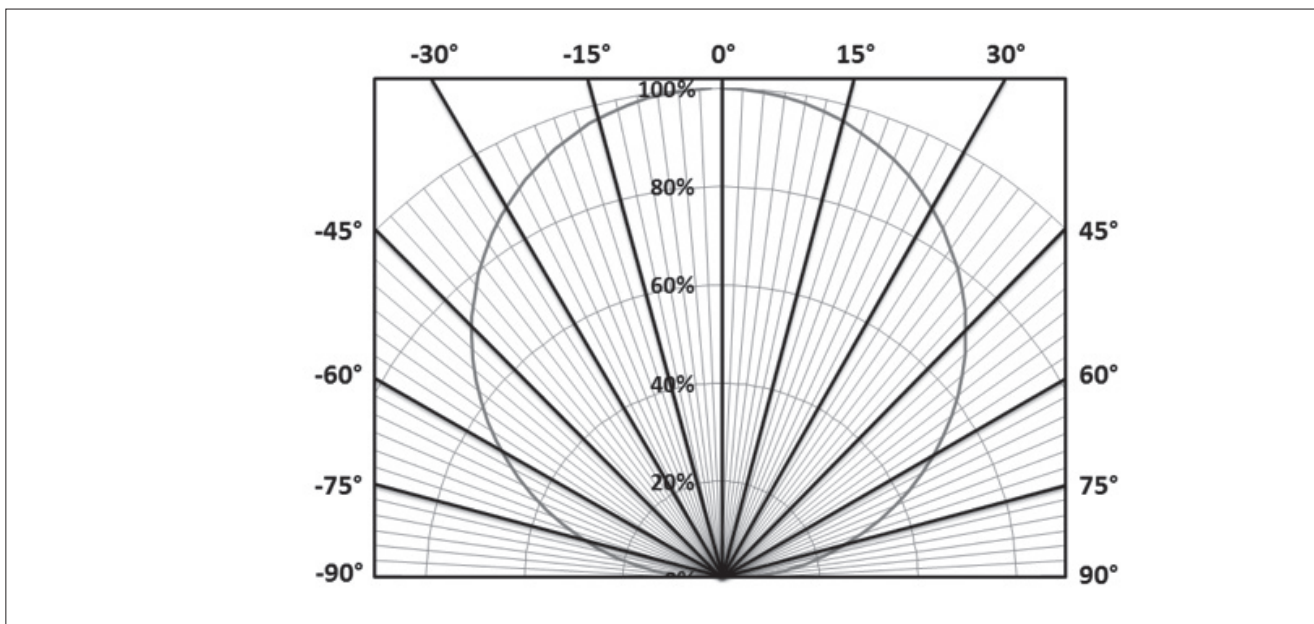

Mechanical Dimensions

Figure 20: V6 HD LED Array

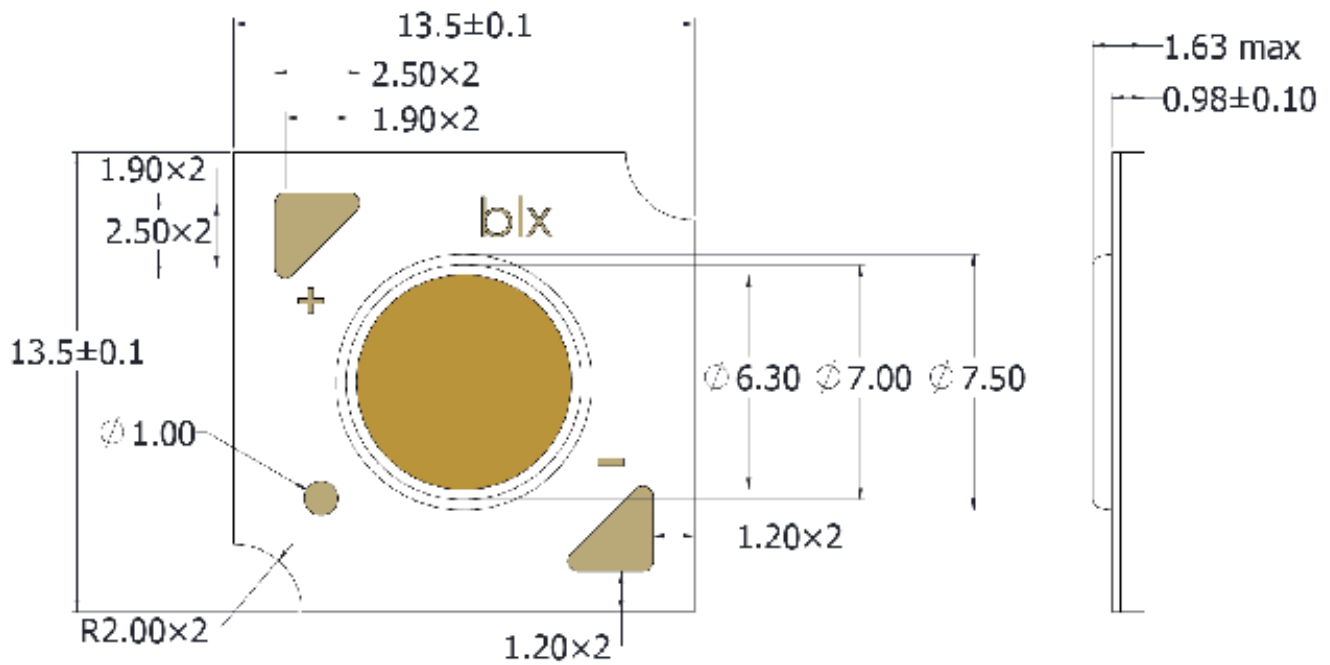

Notes for Figure 20:

1. Drawings are not to scale.
2. Drawing dimensions are in millimeters.
3. Unless otherwise specified, tolerances are ± 0.1 mm.
4. Solder pad labeled "+" denotes positive contact.
5. Refer to Application Notes AN101 for product handling, mounting and heat sink recommendations.
6. The optical center of the LED Array is nominally defined by the mechanical center of the array to a tolerance of ± 0.2 mm.
7. Bridgelux maintains a flatness of 0.10mm across the mounting surface of the array.

Packaging and Labeling

Figure 21: V6 HD Packaging



Notes for Figure 21:

1. Each tube holds 35 V6 HD COB arrays.
2. One tube is sealed in an anti-static bag. Four bags are placed in a shipping box. Depending on quantities ordered, a bigger shipping box, containing four boxes may be used to ship products.
3. Each bag and box is to be labeled as shown above.
4. Dimensions for each tube are 15.4 (W) x 8.3 (H) x 430 (L) mm. Dimensions for the anti-static bag are 75 (W) x 615 (L) x 0.075 (T) mm. Dimensions for the shipping box are 58.7 x 13.3 x 7.9 cm

Packaging and Labeling

Figure 22: Product Labeling

Bridgelux COB arrays have laser markings on the back side of the substrate to help with product identification. In addition to the product identification markings, Bridgelux COB arrays also contain markings for internal Bridgelux manufacturing use only. The image below shows which markings are for customer use and which ones are for Bridgelux internal use only. The Bridgelux internal manufacturing markings are subject to change without notice, however these will not impact the form, function or performance of the COB array.



Design Resources

Application Notes

Bridgelux has developed a comprehensive set of application notes and design resources to assist customers in successfully designing with the V Series HD product family of LED array products. For all available application notes visit www.bridgelux.com.

Optical Source Models

Optical source models and ray set files are available for all Bridgelux products. For a list of available formats, visit www.bridgelux.com.

3D CAD Models

Three dimensional CAD models depicting the product outline of all Bridgelux V Series HD LED arrays are available in both IGS and STEP formats. Please contact your Bridgelux sales representative for assistance.

LM80

LM80 testing has been completed and the LM80 report is now available. Please contact your Bridgelux sales representative for LM-80 report.

Precautions

CAUTION: CHEMICAL EXPOSURE HAZARD

Exposure to some chemicals commonly used in luminaire manufacturing and assembly can cause damage to the LED array. Please consult Bridgelux Application Note AN101 for additional information.

CAUTION: RISK OF BURN

Do not touch the V Series HD LED array during operation. Allow the array to cool for a sufficient period of time before handling. The V Series HD LED array may reach elevated temperatures such that could burn skin when touched.

CAUTION

CONTACT WITH LIGHT EMITTING SURFACE (LES)

Avoid any contact with the LES. Do not touch the LES of the LED array or apply stress to the LES (yellow phosphor resin area). Contact may cause damage to the LED array.

Optics and reflectors must not be mounted in contact with the LES (yellow phosphor resin area).

Disclaimers

MINOR PRODUCT CHANGE POLICY

The rigorous qualification testing on products offered by Bridgelux provides performance assurance. Slight cosmetic changes that do not affect form, fit, or function may occur as Bridgelux continues product optimization.

STANDARD TEST CONDITIONS

Unless otherwise stated, array testing is performed at the nominal drive current.

About Bridgelux: Bridging Light and Life™

At Bridgelux, we help companies, industries and people experience the power and possibility of light. Since 2002, we've designed LED solutions that are high performing, energy efficient, cost effective and easy to integrate. Our focus is on light's impact on human behavior, delivering products that create better environments, experiences and returns—both experiential and financial. And our patented technology drives new platforms for commercial and industrial luminaires.

For more information about the company, please visit

bridgelux.com

twitter.com/Bridgelux

facebook.com/Bridgelux

linkedin.com/company/bridgelux-inc-_2

youtube.com/user/Bridgelux

WeChat ID: BridgeluxInChina



46430 Fremont Boulevard

Fremont, CA 94538 USA

Tel (925) 583-8400

www.bridgelux.com

X-ON Electronics

Largest Supplier of Electrical and Electronic Components

Click to view similar products for [High Power LEDs - White category:](#)

Click to view products by [Bridgelux manufacturer:](#)

Other Similar products are found below :

[LTW-K140SZR40](#) [B42180-08](#) [STW8Q2PA-R5-HA](#) [LTPL-P00DWS57](#) [LTW-K140SZR30](#) [LZP-D0WW00-0000](#) [SZ5-M1-WW-C8-V1/V3-FA](#) [LTW-K140SZR57](#) [LTW-K140SZR27](#) [BXRE-50C2001-C-74](#) [MP-5050-8100-27-80](#) [MP-5050-6100-65-80](#) [MP-5050-6100-40-80](#) [MP-5050-6100-30-80](#) [KW DPLS32.SB-6H6J-E5P7-EG-Z264](#) [L1V1-507003V500000](#) [KW CULPM1.TG-Z6RF7-ebvFfcbB46-65G5](#) [KW DMLS33.SG-Z6M7-EBVFFCBB46-8E8G-700-S](#) [KW DPLS33.KD-HIJG-D30D144-HN-22C2-120-S](#) [KW DDLM31.EH-5J6K-A737-W4A4-140-R18](#) [GW JTLRS1.CM-K1LW-XX57-1-100-Q-R33](#) [KW DDLM31.EH-5J6K-A636-W4A4-140-R18](#) [KW DDLM31.EH-5J6K-A131-W4A4-140-R18](#) [SML-LXL8047MWCTR/3](#) [L2C5-40HG1203E0900](#) [JB3030AWT-P-U27EA0000-N0000001](#) [JK3030AWT-P-U30EA0000-N0000001](#) [JK3030AWT-P-B40EB0000-N0000001](#) [JK3030AWT-P-H30EB0000-N0000001](#) [JK3030AWT-P-H40EB0000-N0000001](#) [JK3030AWT-P-U27EB0000-N0000001](#) [JK3030AWT-P-U30EB0000-N0000001](#) [GW PUSTA1.PM-PAPC-XX53-1-1050-R18](#) [BXRE-30E4000-C-83](#) [BXRE-50C6501-D-84](#) [BXRE-27E1000-B-83](#) [BXRE-30G0800-D-83](#) [BXRE-50C4001-B-84](#) [BXRE-50C6501-C-84](#) [BXRH-40E4000-F-83](#) [BXRH-27G4000-F-83](#) [BXRE-27G30H0-D-82](#) [BXRE-27G4000-B-83](#) [BXRE-40E1000-B-83](#) [BXRE-40E6500-D-83](#) [BXRH-27E1000-B-83](#) [BXRH-27E1000-G-83](#) [BXRH-27E4000-F-83](#) [BXRH-27G1000-B-83](#) [BXRH-30E0600-A-83](#)