



# Bridgetek

BRIDGING TECHNOLOGY



Embedded Video  
Engine (EVE) Modules



Development  
Modules



FT8xx Series  
ICs - EVE



FT9xx Series  
32-bit MCU



CleO - The Smart TFT  
Display for Arduino

## Display Solutions & Microcontrollers

[www.brtchip.com](http://www.brtchip.com)



*"By spinning our Microcontroller units and Human Machine Interface divisions into a new company brand Bridgetek, we will be much better positioned, both strategically and logistically speaking, to explore the multitude of opportunities now opening up within contemporary embedded design."*

*"Rather than being spread across a large scope of activities and thus too diluted to be truly effective, the separate entities of FTDI and Bridgetek will be able to attend to their respective markets and bring real value to customers," states Founder and CEO, Fred Dart.*

# EVE, THE EMBEDDED VIDEO ENGINE

Bridgetek has redefined the cost and quality paradigm for graphic user interface (GUI) development with the introduction of the FT8XX range of display products with Embedded Video Engine (EVE) technology. The EVE family combines display, audio and touch into a single chip, providing an optimized solution with high quality graphics that output to 1/16th pixel resolution for WVGA, VGA, SVGA (FT81x), WQVGA and QVGA (FT80x) TFT display panels. The first device in the series, the FT800, launched in 2013 and took the titles of British Engineering Excellence 'Electronic Product of the Year' and Elektra 'Digital Semiconductor of the year', within the same year, where the product was described as providing 'versatility and innovation' and 'the technological capabilities with efficiencies that differentiate it from its competitors'.

With its revolutionary EVE technology deploying an object-oriented approach, the series is capable of simplifying the implementation of intelligent displays – reducing bill of material costs, power budget, board space, and development time.

The wide range of products includes an extensive choice of development systems including the 'Basic' series of modules which feature an SPI interfaced subsystem, the 'Plus' series of modules providing an Arduino-compatible ecosystems and the 'ME' series of daughter boards for Bridgetek's FT90x 32bit MCU series. In addition to this, an extensive library of technical documentation, application sample software and design tools provide a simple solution for engineers to further shorten design cycles and reduce BOM costs.

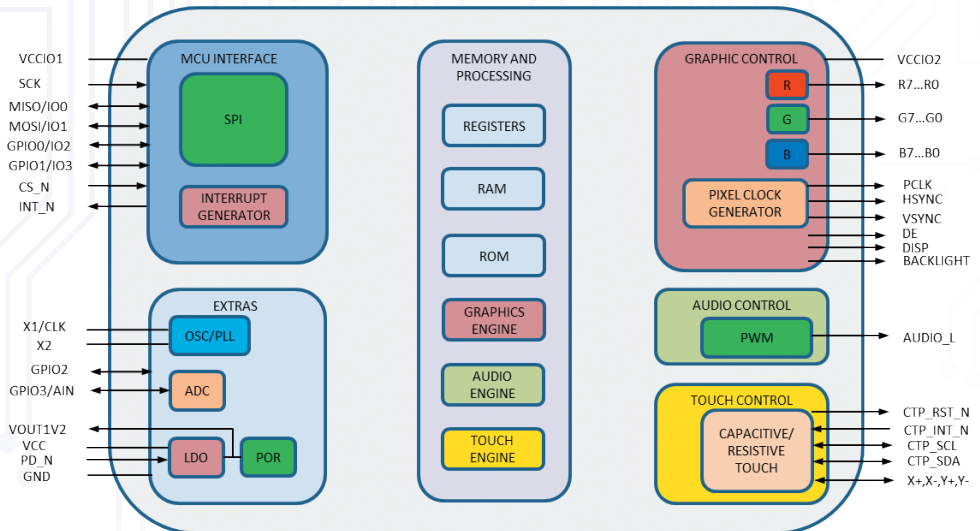

# EVE IC SOLUTIONS

Bridgetek offers a comprehensive range of ICs for EVE solutions:

Device	FT800	FT801	FT810	FT811	FT812	FT813
Target display Resolution	HVGA, WQVGA, QVGA	HVGA, WQVGA, QVGA	HVGA, VGA, WVGA, SVGA	HVGA, VGA, WVGA, SVGA	HVGA, VGA, WVGA, SVGA	HVGA, VGA, WVGA, SVGA
RGB interface	18 bits (RGB666)	18 bits (RGB666)	18 bits (RGB666)	18 bits (RGB666)	24 bits (RGB888)	24 bits (RGB888)
Touch function	Resistive touch	Interface to Capacitive touch controller over I2C	Resistive touch	Interface to Capacitive touch controller over I2C	Resistive touch	Interface to Capacitive touch controller over I2C
Control interface	SPI/I2C	SPI/I2C	SPI/QSPI	SPI/QSPI	SPI/QSPI	SPI/QSPI
Object Memory size	256KB	256KB	1MB	1MB	1MB	1MB
Audio Out	Mono channel	Mono channel	Mono channel	Mono channel	Mono channel	Mono channel
Analogue In	No	No	No	No	Mono channel	Mono channel
Backlight control	Yes	Yes	Yes	Yes	Yes	Yes
Image decoder	BMP, DXTI, software JPG	BMP, DXTI, software JPG	BMP, DXTI, hardware JPG	BMP, DXTI, hardware JPG	BMP, DXTI, hardware JPG	BMP, DXTI, hardware JPG
Supply Power	3.3V	3.3V	3.3V	3.3V	3.3V	3.3V
Host Interface IO voltage	1.8 – 3.3V	1.8 – 3.3V	1.8 – 3.3V	1.8 – 3.3V	1.8 – 3.3V	1.8 – 3.3V
Clock Oscillator	Internal/ External	Internal/ External	Internal/ External	Internal/ External	Internal/ External	Internal/ External
Operating Temp.	-40°C to 85°C	-40°C to 85°C	-40°C to 85°C	-40°C to 85°C	-40°C to 85°C	-40°C to 85°C
GPIOs	3	3	3	3	5	5
Package	QFN48	QFN48	QFN48	QFN48	QFN56	QFN56

# EVE DEVELOPMENT PLATFORMS

The EVE series includes a range of development modules in addition to a number of LCD and Bezel options. The modules are provided in a variety of form factors, and are designed specifically to assist with design and development

## VM800C/VM810C – Credit Card Sized Module

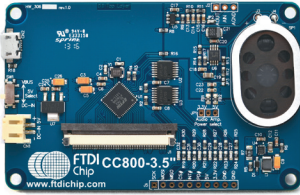

The simple VM800C/VM810C modules are credit card sized and use highly integrated EVE graphical controller ICs. They are offered with or without displays and can support 3.5", 4.3" or 5" TFT LCDs. A 4-wire resistive touch screen can be interfaced to the specified LCD, and the modules come equipped with an audio power amplifier and a microspeaker which enables mono audio output.

The boards can be powered at 3.3V or 5V and they provide an SPI master interface to connect to the system microcontroller.

## VM800B/VM801B – FT800/FT801 Basic Modules with Bezel Enclosure

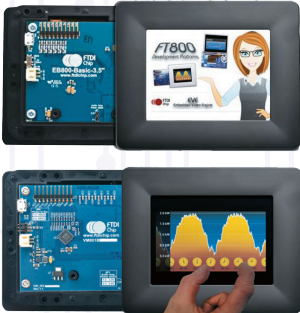

The VM800B and VM801B Basic modules expand on the VM800C product by offering the same functionality, and provide a high quality display system in an elegantly designed, form-fitted bezel. Offered in black or pearl colours, these display sub-systems provide the engineer with a low priced option which can shorten development time whilst enabling a production finished look and are designed to control 3.5", 4.3" or 5" TFT displays.

The VM800B offers these innovative features with a resistive touch display whilst the VM801B comes integrated with a capacitive multi-touch screen LCD panel.

## VM800BU – FT800 Basic USB Modules with Bezel Enclosure



The VM800BU provides a USB controller development module for Bridgetek's FT800, and can be used to develop and demonstrate the functionality of the FT800 with Embedded Video Engine EVE technology. This module interfaces with a system controller via a USB port, accessing the onboard FT232HL bridge chip to connect to the FT800 SPI port.

Designed for use in industrial or commercial environments, the VM800BU series supports a range of sizing options: 3.5", 4.3" and 5", and comes equipped with a hard wearing, precision fit bezel in a choice of black (-BK) or pearl (-PL) colours

## VM800P/VM80IP – FT800/FT801 Plus Modules (Arduino compatible)



The VM800P and VM80IP 'Plus' modules further extend system integration by providing a complete video subsystem with an embedded microcontroller in resistive touch and capacitive multitouch variants. In addition to the features supplied with the basic modules, this system provides an in-built MCU, the ATMEGA328P, which is supported by Arduino libraries.

Further functionality is provided in the form of a Real Time Clock (RTC) with battery back up and an SD card connector plus preloaded 4GB SD Card, allowing for demonstration code to be easily sampled.

Plug in daughter cards are available to expand the IO capability to include GPIO, RS232, RS422, RS485 and Ethernet, promoting improved connectivity and the ability to transmit over longer distances.

Device	VM8xxC	VM800B	VM801B	VM800BU	VM800P	VM80IP
Main EVE Controller	FT800 /FT810	FT800	FT801	FT800	FT800	FT801
Display Included	Optional	Y	Y	Y	Y	Y
Display Size	3.5", 4.3"and 5"	3.5", 4.3"and 5"	4.3"and 5"	3.5", 4.3"and 5"	3.5", 4.3"and 5"	4.3"and 5"
Bezel Enclosure	N	Y	Y	Y	Y	Y
Bezel Color	N/A	Black/Pearl	Black/Pearl	Black/Pearl	Black/Pearl	Black/Pearl
Touch function	Resistive touch	Resistive touch	5 points Capacitive touch	Resistive touch	Resistive touch	5 points Capacitive touch
Audio Speaker	Y	Y	Y	Y	Y	Y
Backlight LCD driver	Y	Y	Y	Y	Y	Y
Embedded MCU	N	N	N	N	Embedded ATMEGA 328P MCU	Embedded ATMEGA 328P MCU
Host Interface	SPI	SPI	SPI/I2C	USB	N/A	N/A
Daughter Board Interface	N	N	N	N	Y	Y
Micro SD	N	N	N	N	Y (4GB)	Y (4GB)
Battery Backed RTC	N/A	N/A	N/A	N/A	Y	Y
Power Source	3.3V or 5V	3.3V or 5V	3.3V or 5V	5V	5V	5V
Module Series	VM800C35A-N, VM800C43A-N, VM800C35A-D, VM800C43A-D, VM800C50A-D VM810C50A-D	VM800B35A-BK, VM800B43A-BK, VM800B50A-BK, VM800B35A-PL, VM800B43A-PL, VM800B50A-PL	VM801B43A-BK, VM801B50A-BK, VM801B43A-PL, VM801B50A-PL	VM800BU35A-BK, VM800BU43A-BK, VM800BU50A-BK, VM800BU35A-PL, VM800BU43A-PL, VM800BU50A-PL	VM800P35A-BK, VM800P43A-BK, VM800P50A-BK, VM800P35A-PL, VM800P43A-PL, VM800P50A-PL	VM801P43A-BK, VM801P50A-BK, VM801P43A-PL, VM801P50A-PL

# ACCESSORIES FOR VM800P/VM801P PLUS RANGE

An extensive range of expansion cards designed to support the VM800P and VM801P modules allow EVE to connect to a wider system and become the focal point of it's control and display interface. With a simple Arduino SPI interface accessed over the VM800P or VM801P Micro-MaTch connectors, access to Serial, Control and even Ethernet systems can be achieved.

## Serial Adaptors:

**VI800A-TTLU** Full Duplex UART bridge, speed up to 5M Baud, 5V tolerant I/O, GPIO (4 input/4 output), Status LED

**VI800A-232U** Full Duplex RS232 bridge, speed up to 1M Baud, GPIO (4 input/4 output), Status LED

**VI800A-N485U** Full Duplex RS485 bridge, speed up to 500Kbps, GPIO (4 input/4 output), Status LED

## Control Adaptor:

**VI800A-RELAY** 4 Changeover Relays and 4 Opto-Isolated Inputs bridge, Status LEDs

## Network Adaptors:

**VI800A-ETH** Ethernet Bridge, 10/100M base-T, RJ45 connector with status LEDs

**VI800A-POE** Power over Ethernet Bridge, 10/100M base-T, RJ45 connector with Status LEDs

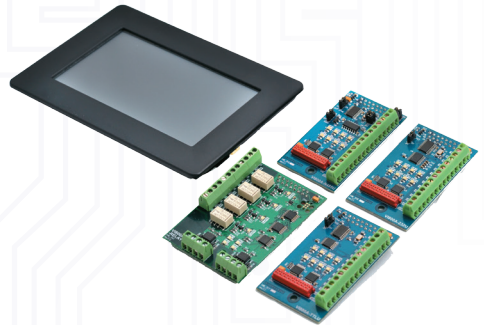

## Other EVE Accessories

**VA800A-PROG** Arduino Boot Loader recovery module that offers an alternative access port to the ATMEGA328P of the VM800P/VM801P

**VA800A-SPI** High Speed Micro USB to SPI Adapter for VM800C/VM800B/VM801B Credit or Basic boards based on FT232H MPSSE design.

**VA-FC-STYLUSI** Resistive Touch Screen Pen Stylus

**VA-FC-1M-BKW** Flat USB to Micro B Cable 1M – Black and White **VA-FC-1M-BLW** Flat USB to Micro B Cable 1M – Blue and White **VA-PSU-UKI** UK Model 5V/1A USB Power Supply

**VA-PSU-USI US** Model 5V/1A USB Power Supply

**VA-PSU-EUI EU** Model 5V/1A USB Power Supply

# ME81x HMI Modules

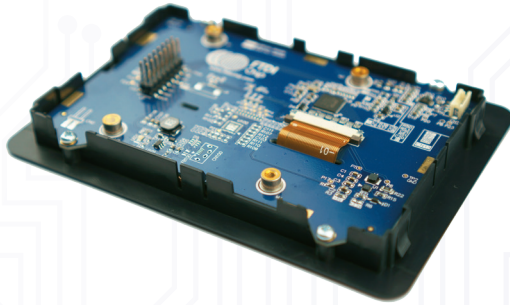

The ME81x modules provide a display, audio and touch HMI companion for any MCU with USB, SPI or QSPI interfacing capabilities. Included in the module assembly are Bridgtek's FT81x graphics controllers with Embedded Video Engine (EVE) technology, driving full colour TFT panels with either resistive or capacitive touch, ranging from 3.5" to 5" in size. The module is fully equipped with a black colour form-fitted bezel, LCD backlight control, audio buzzer and an EVE IO connector to interface with the MM900EVxx modules or custom MCU boards.

Bridgtek provides a set of design examples, demonstrating support for FT90x (our 32-bit SuperBridge MCU offering) + FT81x total solutions. Additionally the EVE Screen Editor and EVE Screen Designer development utilities are now available with support for EVE2 directly from our website. These utilities are provided to assist designers wishing to experiment with creating display lists, utilising a simple "drag and drop" method to control the EVE graphic controller.

	ME810A-HV35R	ME812A-WH50R	ME812AU-WH50R	ME813A-WH50C	ME813AU-WH50C
<b>Controller</b>	FT810Q	FT812Q	FT812Q	FT813Q	FT813Q
<b>Display</b>	3.5"	5"	5"	5"	5"
<b>Display type</b>	Vertical	Horizontal	Horizontal	Horizontal	Horizontal
<b>Resolution</b>	320x480	800x480	800x480	800x480	800x480
<b>Touch</b>	Resistive	Resistive	Resistive	Capacitive	Capacitive
<b>Interface</b>	SPI/QSPI	SPI/QSPI	USB	SPI/QSPI	USB
<b>Audio out</b>	Buzzer	Micro Speaker	Micro Speaker	Micro Speaker	Micro Speaker
<b>Bezel</b>	Yes	Yes	Yes	No	No
<b>Color</b>	Black(-BK)	Black(-BK)	Black(-BK)	Black(-BK)	Black(-BK)



# EVE DEVELOPMENT SUPPORT

Bridgetek provides the ability to work on projects utilising a variety of tools and programming techniques. Samples are provided for a variety of different MCU families including ATMEL (Arduino) Freescale, PIC and ARM.

## HAL – Hardware Abstraction Layer

The HAL takes all the low level HEX values for each function call and wraps them up to a high level function call to enable the user to focus on the display list contents without too much concern for how the SPI traffic is created and dispatched. The HAL supports MPSSE cables and Arduino PCBs and provides an excellent starter platform.

## Arduino Library

This library has been created in a syntax which will be familiar to Arduino users, in order to enable rapid prototyping of FT800/ FT801 applications with Arduino Pro and Uno form factors.

## EVE Emulator Library

This is a PC based tool which allows simulation of display list commands. The simulator provides the user with the ability to rapidly experiment with changes to their display list, without the need for hardware. The user can then become familiar with the EVE display list and create attractive, high impact displays before porting code to the system processor.

## Arduino Library (AN\_318)

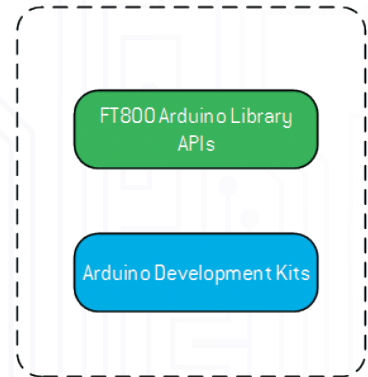
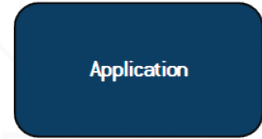

## HAL Structure (AN\_246)

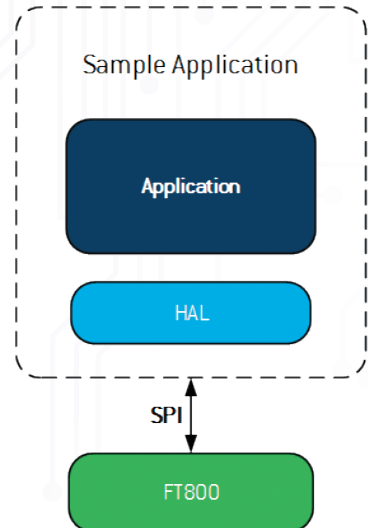

# EVE APPLICATION EXAMPLES

As engineers come to understand EVE's programming language, the recommended starting point for design development is through the use of the Sample Application. These detailed software scripts provide easy-to-use code, where the designer can start to experiment with the EVE language and Basic series development kits.

By loading the sample application into a C compiler (e.g. Visual Studio), connecting/enabling a USB to SPI cable accessory (e.g. VA800A-SPI) and connecting it to the VMBOX basic kits, the user can create a PC to target environment where they can readily interface to the FT80X and render graphics onto the display (i.e. through the use of break-points and executes). When the designer is comfortable with EVE's instruction set, the complete display description is created via text entry, through the use of the Sample Application and Bridgetek reference examples. This operation is most likely to be accomplished in the C compiler of the system host micro-controller.

A range of sample applications are available to demonstrate how to initialize the FT800/ FT801 and develop display lists of primitive objects. These can be used as building blocks to create vibrant and dynamic images. Projects can be realised from a variety of tool and programming techniques, supporting anything from very basic EVE functions to sophisticated, animated and interactive demos.

## Hardware

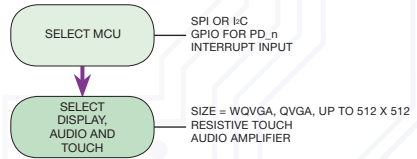

## Software

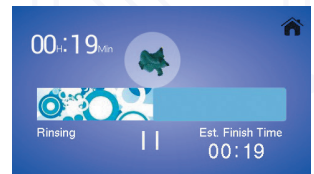
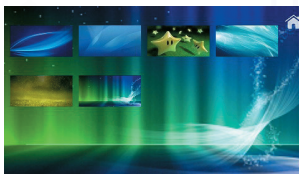
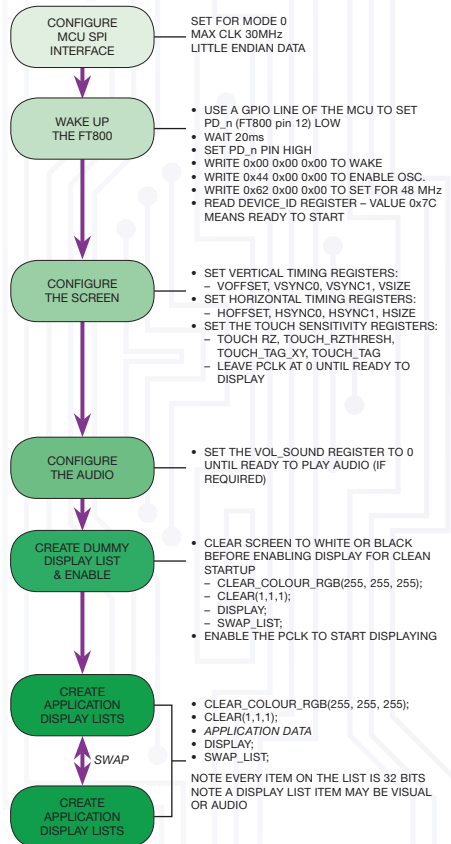

# EVE DEVELOPMENT UTILITIES

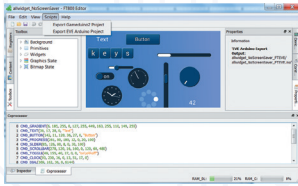

## EVE Screen Editor

The EVE Screen Editor is a WYSIWYG GUI tool which enables engineers to study display commands interactively. It can also be utilised to access a number of various EVE development platforms (such as the EVE Basic and Credit Card Series Development modules) via an MPSSE cable, without the need for any supplementary code to be written.

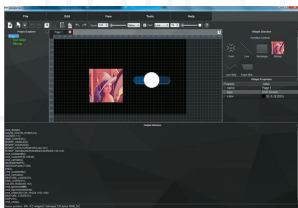

## EVE Screen Designer

The EVE Screen Designer has been created specifically for User Interface (UI) designers. With this tool, designers can construct a stunning UI easily using widgets and images to replace the traditional full range graph UI design without any programming required

Feature	Screen Editor	Screen
Widget concept	N	Y
Edit display list	Y	N
View display list	Y	Y
Zoom in/out widgets and screen	N	Y
Align widgets in screen	N	Y
Multi-Page (screen) design	N	Y
Grid assistance in screen	N	Y
Widgets multi- selection	N	Y
Widgets copy/cut/ paste	N	Y
Screen copy/ paste/ move	N	Y
Undo/Redo	N	Y
Save Screen shot	N	Y
Rotate resize translate bitmap widget	N	Y

Feature	Screen Editor	Screen
Group the widgets	N	Y
Z-order of widgets	N	Y
Lock/unlock widgets	N	Y
Area multi widgets selection	N	Y
Multi-Language for UI	N	Y
Designed for	Programmers	Designers
Emulator Based	Y	Y
Project history	N	Y
Project Autosave	N	Y
Debug /step by step display list	Y	N
Hardware platform sync	Y	N
Pixel trace	Y	N
Register/Memory viewer	Y	N
Export to platform project	Y	N

# Ultimate Bridging Solutions with 8-bit and 32-bit MCUs

Bridging technologies is the Bridgetek company mission, and our range of products and services are designed and manufactured to facilitate this. Our series of microcontrollers (MCUs) have been developed with key functionality to enable enhanced system performance and operational efficiency.

Based upon Bridgetek's FT32, high performance 32-bit RISC core, the FT90X series provides a plethora of connectivity options, making it the ideal choice for advanced technology bridging solutions. By executing instructions from shadow RAM, rather than flash memory, the FT90X can operate at true Zero Wait States (OWS) up to 100MHz and 310 DMIPS (at 100MHz) performance.

Using the industry standard GCC compiler, together with the Eclipse IDE, allows the FT90X to utilise a wide variety of third-party and open source software.

For applications with lower performance requirements, the FT51A, based on an 8-bit core gives 48MIPS processing performance. The FT51A integrates a Low/Full Speed USB hub and provides a downstream port, allowing multiple devices to be cascaded or combined with other USB devices. In addition to standard 8051 functions, the FT51A includes multiple ADC facilitating analog measurement applications along with a fully configurable USB Device Controller, analogous to the FTDI Chip FT12 series.

The toolchain for the FT51A comprises SDCC compiler integrated together with Eclipse IDE, thus providing a tried and tested development solution for a proven CPU architecture.

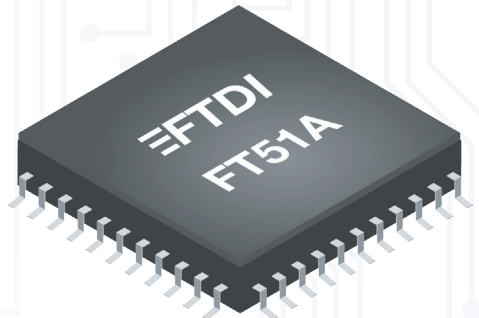
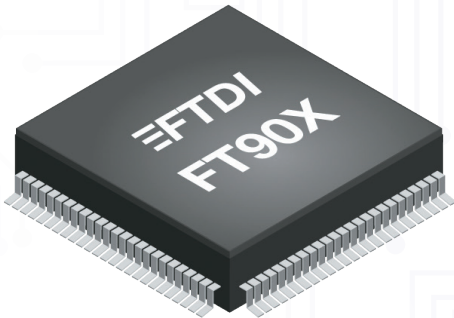

# FT90X Series

The FT90X series has been developed for high speed, interface bridging tasks. With a parallel camera input, 10/100 Base-TX Ethernet interface, CAN bus, and USB2.0 Hi-Speed peripheral and host ports, this device offers excellent interconnect capabilities and fast data rates.

## Enhanced features:

- 32-bit RISC architecture
- 256kB program/shadow memory
- High speed operation – 3.1 DMIPS per MHz
- 64kB data memory
- True Zero Wait State operation up to 100MHz
- USB DFU Bootloader

## Standard features:

- User programmable EFUSE for memory and security configuration
- Integrated Phase-Locked Loop (PLL) supports external crystal and clock source input
- 32.768kHz RTC clock support
- Four user timers with prescale and watchdog function
- 3.3V single supply operation
- Internal voltage regulator +1.2V to the digital core for lower power consumption
- Supports Battery Charging Specification, for USB2.0 Hi-Speed peripheral port
- Integrated power-on-reset circuit
- Pb-free, RoHS packaging, 100QFN, 100LQFP, 76QFN and 80LQFP options

## Digital connectivity:

- Direct camera input via a parallel data interface
- USB2.0 Hi-Speed (480Mbps) device controller with Battery Charge Detection (BCD)
- USB2.0 Hi-Speed (480Mbps) host controller with BCD emulation
- 10/100 BASE-TX Ethernet MAC and PHY; compliant with the IEEE 802.3/802.3u standards
- Two CAN 2.0 controllers for data transfer up to 1M bit/s
- I<sup>2</sup>S master/slave interface supporting up to 24b/192MHz
- Host SD controller compliant with standard specification V3.0, which supports UHS50 and UHS104 cards
- SPI master supports single/dual/quad modes
- Two SPI slaves support single data transfer with 25MHz clock
- UART interface configured as 1 Full UART or 2 basic UARTs (TX/RX/CTS/RTS)
- Two I<sup>2</sup>C bus interfaces can be configured as master or slave, with data transfers up to 3.4Mbps
- Supports eight separate PWM channel outputs with support for PCM 8-bit/16-bit stereo audio output

## Analog connectivity:

- 7 input channel muxed to a single internal ADC
- Two 10 bit DACs

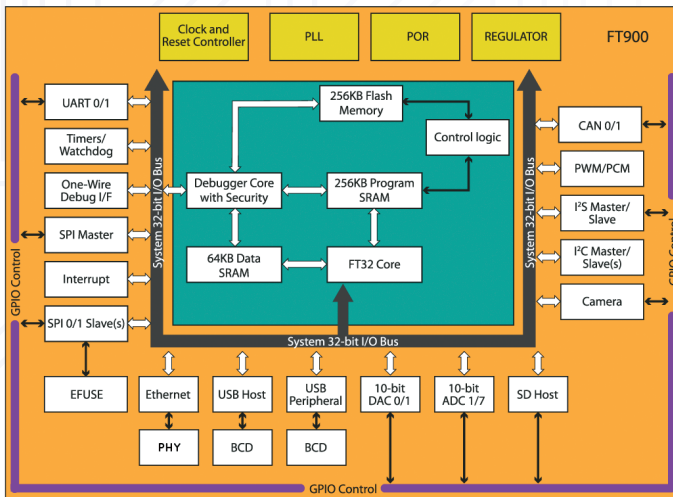

# FT90X Series CPU Performance

The FT90X's FT32 processor core operates at 3.1DMIPs/MHz, and with a Zero Wait State program memory clocking up to 100MHz. The FT90X MCU's unique data streaming domain eliminates the need for complex direct memory access (DMA) interfacing to transfer data internally providing a highly deterministic processing model. The comparison of CPU performance is shown below:

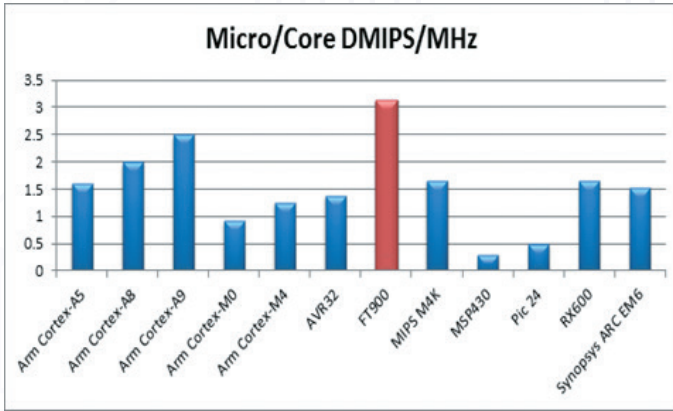

# FT90X Series Device Solutions

Part Number	Package	CAN2.0	Ethernet IO/100M	Camera VGA	SD3.0	I <sup>2</sup> S Master and Slave	Others*
FT900Q	100QFN	Y	Y	Y	Y	Y	Y
FT900L	100LQFP	Y	Y	Y	Y	Y	Y
FT901Q	100QFN	-	Y	Y	Y	Y	Y
FT901L	100LQFP	-	Y	Y	Y	Y	Y
FT902Q	100QFN	Y	-	Y	Y	Y	Y
FT902L	100LQFP	Y	-	Y	Y	Y	Y
FT903Q	100QFN	-	-	Y	Y	Y	Y
FT903L	100LQFP	-	-	Y	Y	Y	Y
FT905Q	76QFN	Y	Y	-	-	-	Y
FT905L	80LQFP	Y	Y	-	-	-	Y
FT906Q	76QFN	-	Y	-	-	-	Y
FT906L	80LQFP	-	Y	-	-	-	Y
FT907Q	76QFN	Y	-	-	-	-	Y
FT907L	80LQFP	Y	-	-	-	-	Y
FT908Q	76QFN	-	-	-	-	-	Y
FT908L	80LQFP	-	-	-	-	-	Y

\*others include all other functions

# FT90X Series Development Modules

## FT90X Development Modules

Based upon Bridgetek's FT32 high performance, 32 bit RISC core, the FT90x series provides a plethora of connectivity options, making it the ideal choice for advanced technology bridging solutions. By executing instructions from shadow RAM, rather than flash memory, the FT90x can operate at true Zero Wait States (OWS) up to 100MHz with 310 DMIPS performance.

## MM900EV Development Modules

The MM900EV development modules provide full hardware feature support for the FT90X processor in a variety of form factors. The modules also provide a connector for accessing external plug-in hardware over an SPI interface. There are three module types available: MM900EV1A, which comes without a camera, MM900EV2A, with an inbuilt front facing CMOS camera, and MM900EV3A, with a back facing camera. The MM900EV-Lite is optimized for HMI and embedded display applications.

### Key features:

- FT90x 100-pin QFN package MCU.
- RJ45 with built in magnetics for IO/100Mbps Ethernet transfer.
- Standard USB-A connector to support USB device connection.
- Micro-B USB for connecting to a USB host or providing a power supply over USB.
- In built audio codec for stereo audio output with 3.5mm headphone jack and mono microphone input.
- Debugger interface for FT90x flash programming and EFUSE configuration.
- +5V alternative power supply DC connector.
- 2x5 pins 1.27mm pitch female Micro-MaTch connector for software download.
- 2x20 pins 2.54mm pitch female header support for external feature expansions.
- 24 pins 0.5mm pitch camera connector and two RGB LEDs (MM900EV2A/3A modules).
- MicroSD card socket supporting SD3.0 specification.
- 2x8 pins 2.54mm pitch dual entry female header and 16 pins 0.5mm pitch FFC/FPC connectors for SPI master to support LCD display modules

## UMFTP2A FT90X series debugger/ programmer module

The UMFTP2A debugger/programmer module provides a USB bridge between the FT90X Eclipse IDE development tools running on a PC and the FT900 I-wire debug pin. This module can be used to program, configure the EFUSE and debug firmware running on the FT900 device.

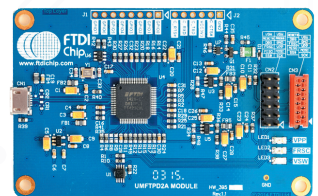
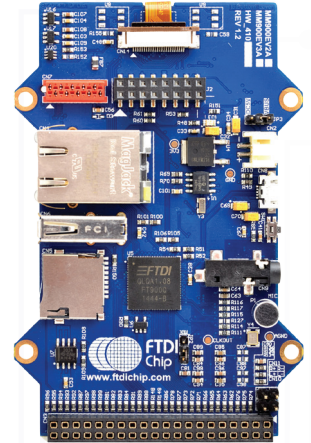

# FT90X Series Development Tools and Software Support

A complete set of tools, from hardware development modules to software code editors, libraries, compilers and debuggers, are available now.

## FT90X Series Firmware Development

Bridgetek provides a development toolchain based on GNU C/C++ and assembly compiler for the FT90X series. It is fully integrated with the open source Eclipse IDE with C/C++ Development Tooling (CDT). The FT90X Eclipse integrated toolset includes FT90X sample applications to enable the ability to start a new project design quickly. An open source real time OS FreeRTOS is ported to the FT90X and comes together with the toolchain.



## Interface Driver Support

The toolchain is supported with a suite of free libraries to control each function block in addition to a collection of USB libraries to enable a range of USB host or device solutions. All drivers will be provided as source code for easy adaptation and modification.

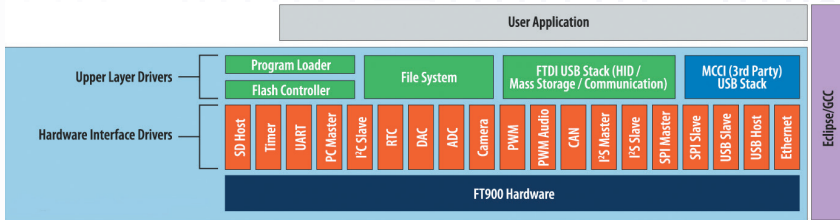

## Firmware Download and Debug

With the plug in developed by Bridgetek, the functionality of Eclipse is extended to support loading of compiled firmware into the target device via a dedicated I-wire debug pin on the ICs. Running and debugging the firmware is also supported via the debugger pin with up to 3 breakpoints supported to assist debug. A dedicated debugger/programmer module is available to support these devices and interface with the Eclipse IDE.

## 3rd Party Tools

Bridgetek have been working closely with 3rd party partners in order to offer additional design aids. A collaboration with MCCI® Corporation, a leading developer of USB drivers and firmware for embedded SoC has resulted in the availability of TrueTask® USB, an embedded USB host stack designed for use with the FT90X MCU product family, and a partnership with MikroE has culminated to provide a comprehensive development environment for the FT90X including compilers, development boards, useful examples for click boards and Visual TFT software support. For more information on MCCI please visit [www.mcci.com](http://www.mcci.com) and visit [www.mikroe.com](http://www.mikroe.com) for details on MikroE.



# FT90X Series Applications

FT90X series is a range of general purpose microcontrollers targeted at high performance systems and as application controllers that can be used in conjunction with EVE display controllers.

## Target Applications include:

- Closed Circuit Monitoring
- Security Network Systems
- Traffic Control
- Audio Players
- Access/Entry Systems
- Industrial Control and Monitoring
- Security Digital Video Recording
- Remote Cameras
- Home Networks
- Back-up Cameras
- IO Interface Bridges ... and many more

## FT90X and EVE Based Video

The FT90X will accept video input from a CMOS camera sensor over the parallel camera interface or from a networked camera over Ethernet. Processing of the image can then be performed within the FT90X to create an FT800 compatible bit-map for output on a QVGA or QCIF display, with a target frame rate of up to 30fps (QCIF).

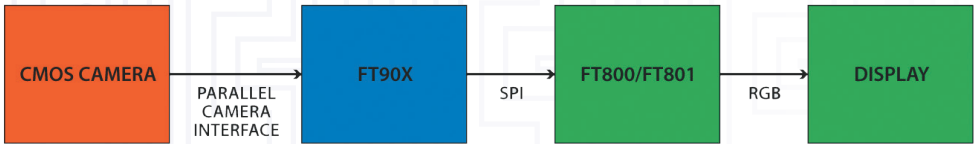

## FT90X Based Audio

By making use of the SD CARD interface and the I<sup>2</sup>S interface to an external codec the FT90X may be used to implement a full feature MP3 player for streaming music and audio file playback.

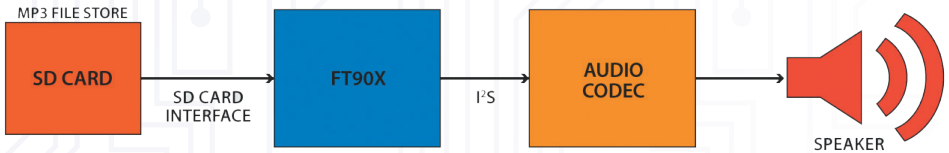

## FT90X Low Cost IP Camera

Easily interface video from a camera sensor via the FT900 to remote location via Ethernet connectivity.



# FT51A Series

The FT51A series provides an 8051-compatible core with best in class performance and unique features including multiple ADCs, USB 2.0 Full Speed Device, and USB hub function targeted at cascading multiple FT51A systems, or to connect an additional USB peripheral like a mouse or keyboard.

## Enhanced Digital features:

- 8051-compatible core running at a maximum frequency of 48MHz
- High speed operation 48MIPs@48MHz
- 16kB program/shadow memory
- 8kB data memory
- True Zero Wait States operation up to 48MHz
- FT12 series compatible USB2.0 Full-Speed/ Low-Speed peripheral controller with Battery Charger Detection (BCD)
- USB downstream port
- Enhanced UART with transfer rates from 300 baud to 3M baud
- Integrated hardware debugger
- PWM Controller
- I<sup>2</sup>C master/slave controller
- SPI master/slave controller
- SPI master/slave controller
- 4 extra timers plus watchdog function
- 8-bit parallel FIFO
- USART/SPI/FIFO, all with DMA options
- Integrated clock generation, no external crystal required
- Enhanced Analog features:
  - 16 Analog IO Cells for ADC function
  - Up to 4 simultaneous ADC
- Standard features:
  - Standard 8051 peripheral set
  - Up to 16 GPIO
  - USB DFU Bootloader
  - Integrated power-on-reset circuit
  - +5V single supply operation
  - Internal 3.3V/1.8V LDO regulators
- Range of compact packaging options available: 48-pin WQFN, 44-pin LQFP, 32-pin WQFN and 28-pin SSOP

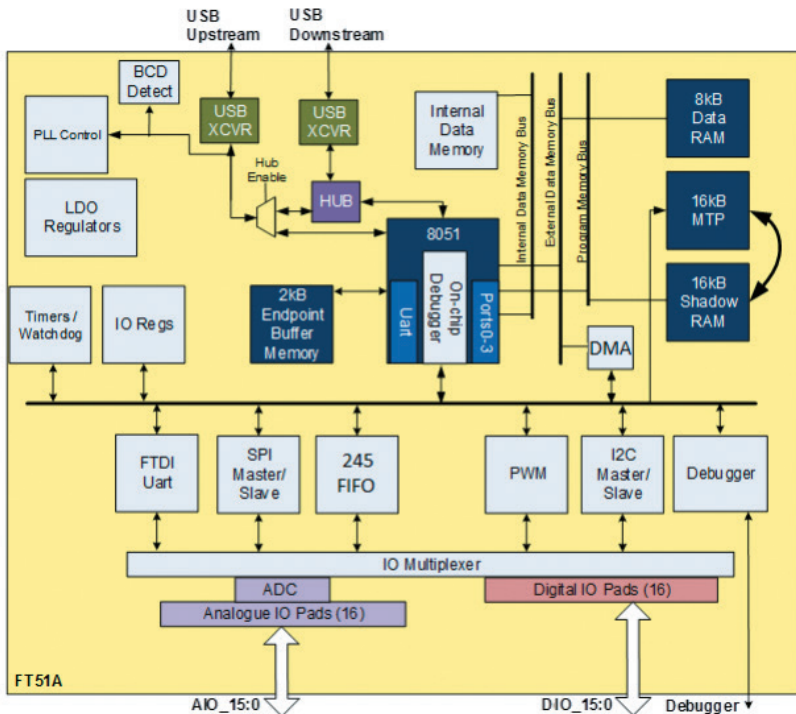

# FT51A Series Development Module

## FT51A EVM FT51A Evaluation Module

The FT51A EVM evaluation module provides full hardware feature support for the FT51A processor and includes several ready to go DAQ circuits allowing almost instant bringup and delivering a simple environment to evaluate/modify and add peripherals to the FT51A at a low cost.

### Key features:

- FT51A at 48MHz
- Built in USB Hub with downstream device support for cascaded devices
- Tri-colour backlight 2x20LCD
- Temperature, force and heart rate detection sensors
- 4 tactile buttons
- 2 controllable LEDs
- Debugger interface for FT51A flash programming
- 2x20 pin IO header allowing easy customisation and addition of extra peripherals

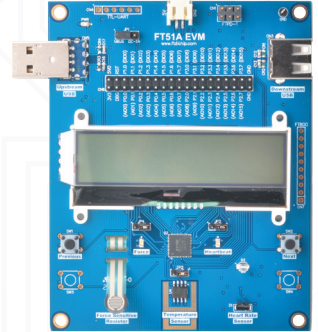

## UMFT51AA 8051 Compatibility Module

The FT51AA module is pin compatible with the DIP40 MCS-51 range of MCUs. The form factor of the module makes it easy to cascade up to four of them together and leverage upon the USB hub feature.

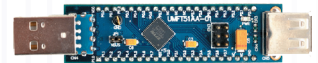

## FTPD-1 FT51A series debugger/programmer module

The FTPD-1 debugger/programmer module provides a USB bridge between the FT51A Eclipse IDE development tools running on a PC and the FT51A 1-wire debug pin. This module can be used to program, configure and debug firmware running on the FT51A device (such as the FT51A EVM evaluation module or the UMFT51AA 8051 compatibility module).

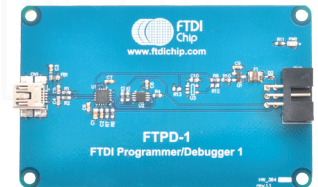

# FT51A Series Development Tools and Software Support

## FT51A Series Firmware Development

The Bridgetek FT51A development tool chain is based on SDCC and is fully integrated in to the open source Eclipse IDE with C/C++ Development Tooling (CDT).

The FT51A Eclipse integrated tool set includes several FT51A sample applications to enable the ability to start a new project design quickly.



## Interface Driver Support

The toolchain is supported with a suite of free libraries to control each function block in addition to a collection of USB libraries to enable a range of USB host or device solutions. Source code is provided for all drivers allowing for easy adaptation and modification.

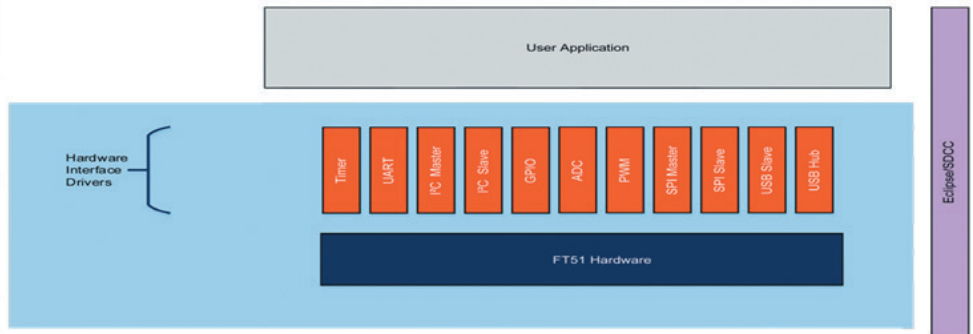

# FT51A Series Applications

The FT51A series offers outstanding performance with an extensive range of interfaces including ADC, SPI, PWM and USB and is ideally suited for control of a distributed network array of sensors/actuators.

A unique USB hub feature of the chip allows multiple devices to be cascaded over USB, back to the main host controller. As a result, the FT51A can be seen as a microcontroller for a single unit, or as a link in a chain of sub-systems that can easily pass data to a USB host system for analysis.

## Target Applications include:

- Cascadable USB DAQ
- Industrial Control
- Multi-room Thermostat
- Window Monitor System
- Security Systems ... and many more
- Fitness Equipment
- Smart Home Control
- Weather Station
- Keyboard with USB mouse port

## FT51A Series Sensor Application

The sensor application example uses the ADC, I<sup>2</sup>C, PWM, GPIO and USB interfaces to create a sensor controller as detailed in the table below.

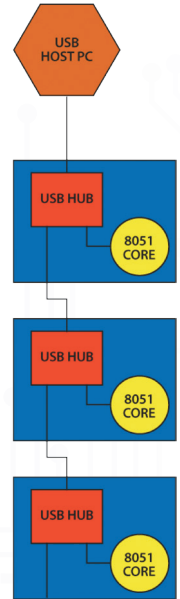
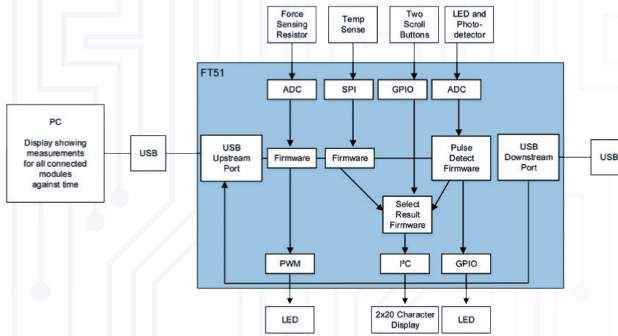

Module Feature	Implementation	FT51A Input	FT51A Output	Display	Logged data / PC display
Pressure sense and display	Potential divider with force sensing resistor.	ADC	PWM, I <sup>2</sup> C	LED brightness intensity Numerical Display of force	Pressure vs time
Heartbeat monitor and display	LED and photo-detector	ADC	GPIO, I <sup>2</sup> C	LED pulses as heart beats Numerical Display of pulse rate	Pulse rate vs time
Body temperature	Temp sensor	SPI	I <sup>2</sup> C	Numerical display of temp	Temp. vs time
Display control feature	Push buttons and 2x20 character display	GPIO	I <sup>2</sup> C	Selected result (pressure, heart rate, temp)	-

Readings are made from each of the sensor inputs and an output is displayed locally on the demonstration PCB as well as being reported back to the PC. Up to 4 boards may be cascaded to increase the amount of data that can be collected and reported back to the PC for storage and analysis. Full source code for this example firmware (targeted to the FT51A EVM module) is available for download.

# CleO – The Smart TFT Display Arduino

CleO is a simple to program, intelligent TFT display solution that allows the construction of human machine interfaces (HMIs) with much higher performance than conventional Arduino display shields are able to deliver. By using it, engineers of all different levels of aptitude (from seasoned professionals right through to keen amateurs) can develop next generation HMIs exhibiting elevated levels of functionality and superior graphical qualities.



## HARDWARE

Adding full colour TFT displays to a design is easy with CleO. Designed as an SPI shield for Arduino based MCUs the board delivers a 3.5" resistive touch display module with on board 8Mbyte eFlash for storing display and audio objects. Extra hi-speed peripherals such as a 5M pixel camera and SD card support is also included as is the option to add an 8ohm/1W speaker.

## Key Features

- Anti-Aliased graphics throughout for much finer image quality with no "jaggies".
- Smooth animations at up to 60 frames/second.
- Portrait and Landscape modes supported
- Inbuilt PWM Audio and speaker amplifier
- File system supports up to 8 simultaneous file operations
- Easy to use Resistive touch
- Fast direct file transfers between micro-SD/eFlash and the Graphics subsystem without using Arduino UNO resources.
- Panel Mount Bezel Included.

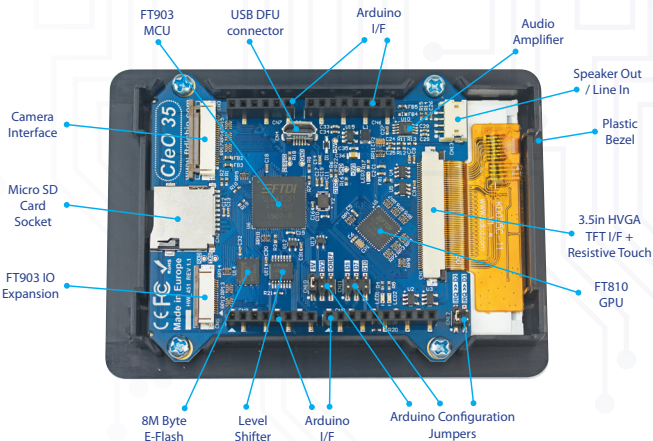

# CleO Development Support

The CleO family of smart TFT display controllers can be easily programmed to give professional looking HMI / GUI's with no prior knowledge of complex graphics programming or mathematics.

With extensive tutorials (20 Chapters covering over 80 topics) + 21 DIY projects included to show you how, CleO35 (the 3.5in display version) allows both hobbyists and professionals alike to add a HVGA ( 320 x 480 pixel ) resistive touch TFT display GUI to their Arduino UNO projects.

CleO is designed to work alongside NerO, our energy efficient enhanced Arduino Compatible board. This accessory delivers >1A current at 5V without overheating, and the long pin version supplied allows CleO to be discretely mounted beneath NerO, leaving the shield headers fully exposed for IO expansion.

To access our full CleO support suite including tutorials, projects and examples and an interactive forum, please visit [www.CleOstuff.com](http://www.CleOstuff.com).

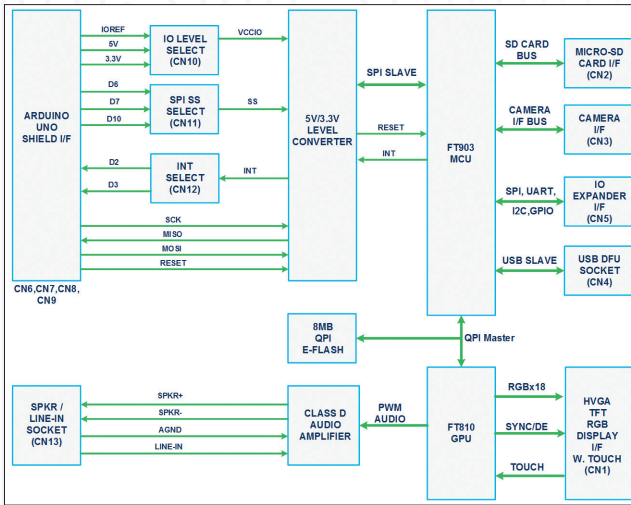

## ACCESSORIES

		
<p>NerO – Energy Efficient Arduino UNO inspired design</p>	<p>CleO Speaker - 8ohm/ 1W peak speaker in plastic case</p>	<p>CleO Camera - 5M pixel camera for capturing video and still images</p>

# About Us

To better serve the broadening range of markets it has developed products for, FTDI Chip has established a new distinct company, Bridgetek.

Bridgetek is a leading global semiconductor company providing high performance microcontroller units (MCUs), display IC products and developing innovative silicon solutions that enhance seamless interaction with latest connectivity technologies.

The key objective from the company is to provide core bridging technology in order to support engineers with highly sophisticated, feature-rich, robust and simple-to-use product platforms. These platforms enable creation of electronic designs with high performance, low peripheral component requirements, low power budgets and minimal board real estate.

Bridgetek resources will be devoted to two particular product areas; the multi-award winning Embedded Video Engine (EVE) graphic controller ICs which enable engineers to implement more sophisticated human machine interface (HMI) systems, plus the unique and equally innovative performance-optimised microcontroller units (MCUs) with their expansive array of different connectivity options and industry-leading processing speeds.



For more information on our products, please visit our website at [www.brtchip.com](http://www.brtchip.com)

## Singapore (HQ)

178 Paya Lebar Road #07-03  
Singapore 409030  
T +65 6547 4827  
F +65 6841 6071



**Taiwan**  
2F No. 516, Sec. 1, NeiHu  
Road Taipei 114, Taiwan  
T +886 (2) 8797 1330  
F +886 (2) 8751 9737

**USA**  
7130 SW Fir Loop Tigard, OR  
97223-8160 USA  
T +1 (503) 547 0988  
F +1 (503) 547 0987

**UK**  
Unit 1, 2 Seaward Place  
Centurion Business Park  
Glasgow, G41 1HH, UK  
T +44 (0) 141 429 2777  
F +44 (0) 141 429 2758

**Vietnam**  
5F Lutaco Tower Building, 173A  
Nguyen Van Troi, Ward II, Phu  
Nhuan District, Ho Chi Minh City  
T +84 (08) 3845 3222  
F +84 (08) 3845 5222



## **X-ON Electronics**

Largest Supplier of Electrical and Electronic Components

*Click to view similar products for [Bridgetek](#) manufacturer:*

Other Similar products are found below :

[BT815Q-T](#) [BT816Q-T](#) [CLEO-CAM1](#) [CLEO-RIO1](#) [CLEO-SPK1](#) [FT51A-EVM](#) [FT51AL-T](#) [FT800Q-R](#) [FT800Q-T](#) [FT801Q-T](#) [FT812Q-T](#)  
[FT900L-T](#) [FT902L-T](#) [FT930Q-T](#) [ME817EV](#) [MM930Lite](#) [MM932LC](#) [MS-C6-8G](#) [NERO-LP1](#) [NERO-NP1](#) [NERO-SP1](#) [UMFT51AA](#)  
[UMFTPD2A](#) [VA800A-PROG](#) [VA-FC-1M-BKW](#) [VA-FC-1M-BLW](#) [VA-FC-STYLUS1](#) [VI800A-N485U](#) [VM800BU35A-PL](#) [VM801B43A-](#)  
[BK](#) [VM801P43A-BK](#)