

Transient Voltage Suppressors (TVS) Data Sheet

Features

- For surface mounted applications in order to optimize board space
- Low profile package
- Built-in strain relief
- Glass passivated junction
- Low inductance
- Excellent clamping capability
- 1500W peak pulse power capability at 10/1000μs waveform, repetition rate (duty cycle): 0.01%
- Fast response time
- Typical I_R less than 1μA above 12V
- High Temperature soldering: 260°C/10 seconds at terminals
- Plastic package has underwriters laboratory flammability 94V-0
- Meets MSL level 1, per J-STD-020
- Safety certification: UL: E244458



Mechanical Data

- Case: JEDEC DO-214AB. Molded plastic over glass passivated junction
- Terminal: Solder plated, solderable per MIL-STD-750, Method 2026
- Polarity: Color band denotes cathode except bi-directional models
- Standard Packaging: 16mm tape (EIA STD RS-481)
- Weight: 0.26g

Applications

- I/O interface
- AC/DC power supply
- Low frequency signal transmission line (RS232, RS485, etc.)

Maximum Ratings and Characteristics

Ratings at 25°C ambient temperature unless otherwise specified.

| Rating | Symbol | Value | Units |
|---|-----------------|--------------|-------|
| Peak pulse power dissipation at 10/1000μs waveform (Note1, Note2, Fig.1) | P_{PPM} | Minimum 1500 | Watts |
| Peak pulse current of at 10/1000μs waveform (Note 1, Fig.3) | I_{PPM} | See Table | Amps |
| Steady state power dissipation at $T_A=50^\circ\text{C}$ (Fig.5) | $P_{M(AV)}$ | 6.5 | Watts |
| Peak forward surge current, 8.3ms single half sine-wave superimposed on rated load, (JEDEC Method) (Note3, Fig.6) | I_{FSM} | 200 | Amps |
| Operating junction and Storage Temperature Range. | T_J, T_{STG} | -55 to +150 | °C |
| Typical thermal resistance junction to lead | $R_{\theta JL}$ | 15 | °C/W |
| Typical thermal resistance junction to ambient | $R_{\theta JA}$ | 75 | °C/W |

Notes: 1. Non-repetitive current pulse, per Fig.3 and derated above $T_A=25^\circ\text{C}$ per Fig.2.

2. Mounted on 8.0mm×8.0mm copper pads to each terminal.

3. 8.3ms single half sine-wave, or equivalent square wave, duty cycle=4 pulses per minutes maximum.

Dimensions (SMC/DO-214AB)

| Symbol | Millimeters | | Inches | |
|--------|-------------|-------|--------|-------|
| | Min. | Max. | Min. | Max. |
| L | 6.60 | 7.11 | 0.260 | 0.280 |
| D | 5.59 | 6.22 | 0.220 | 0.245 |
| D1 | 2.90 | 3.20 | 0.114 | 0.126 |
| T | 7.75 | 8.13 | 0.305 | 0.320 |
| T1 | 0.76 | 1.52 | 0.030 | 0.060 |
| d | - | 0.203 | - | 0.008 |
| H | 2.20 | 2.80 | 0.087 | 0.110 |
| H1 | 2.06 | 2.62 | 0.079 | 0.103 |

Electrical Characteristics (T_A=25°C)

| Part Number | | Device Marking Code | | Reverse Stand-Off Voltage | Breakdown Voltage @I _T | Test Current | Maximum Clamping Voltage @I _{PP} | Peak Pulse Current | Reverse Leakage @V _{RWM} |
|----------------|---------------|---------------------|------|---------------------------|-----------------------------------|---------------------|---|---------------------|-----------------------------------|
| Unidirectional | Bidirectional | UNI | BI | V _{RWM} (V) | V _{BR} (V) | I _T (mA) | V _C (V) | I _{PP} (A) | I _R (μA) |
| 1.5SMC6.8A | 1.5SMC6.8CA | 6V8A | 6V8C | 5.80 | 6.45~7.14 | 10 | 10.5 | 144.8 | 1000 |
| 1.5SMC7.5A | 1.5SMC7.5CA | 7V5A | 7V5C | 6.40 | 7.13~7.88 | 10 | 11.3 | 134.5 | 500 |
| 1.5SMC8.2A | 1.5SMC8.2CA | 8V2A | 8V2C | 7.02 | 7.79~8.61 | 10 | 12.1 | 125.6 | 200 |
| 1.5SMC9.1A | 1.5SMC9.1CA | 9V1A | 9V1C | 7.78 | 8.65~9.55 | 1 | 13.4 | 113.4 | 50 |
| 1.5SMC10A | 1.5SMC10CA | 10A | 10C | 8.55 | 9.50~10.50 | 1 | 14.5 | 104.8 | 10 |
| 1.5SMC11A | 1.5SMC11CA | 11A | 11C | 9.40 | 10.50~11.60 | 1 | 15.6 | 97.4 | 5 |
| 1.5SMC12A | 1.5SMC12CA | 12A | 12C | 10.20 | 11.40~12.60 | 1 | 16.7 | 91.0 | 5 |
| 1.5SMC13A | 1.5SMC13CA | 13A | 13C | 11.10 | 12.40~13.70 | 1 | 18.2 | 83.5 | 1 |
| 1.5SMC15A | 1.5SMC15CA | 15A | 15C | 12.80 | 14.30~15.80 | 1 | 21.2 | 71.7 | 1 |
| 1.5SMC16A | 1.5SMC16CA | 16A | 16C | 13.60 | 15.20~16.80 | 1 | 22.5 | 67.6 | 1 |
| 1.5SMC18A | 1.5SMC18CA | 18A | 18C | 15.30 | 17.10~18.90 | 1 | 25.2 | 60.3 | 1 |
| 1.5SMC20A | 1.5SMC20CA | 20A | 20C | 17.10 | 19.00~21.00 | 1 | 27.7 | 54.9 | 1 |
| 1.5SMC22A | 1.5SMC22CA | 22A | 22C | 18.80 | 20.90~23.10 | 1 | 30.6 | 49.7 | 1 |
| 1.5SMC24A | 1.5SMC24CA | 24A | 24C | 20.50 | 22.80~25.20 | 1 | 33.2 | 45.8 | 1 |
| 1.5SMC27A | 1.5SMC27CA | 27A | 27C | 23.10 | 25.70~28.40 | 1 | 37.5 | 40.5 | 1 |
| 1.5SMC30A | 1.5SMC30CA | 30A | 30C | 25.60 | 28.50~31.50 | 1 | 41.4 | 36.7 | 1 |
| 1.5SMC33A | 1.5SMC33CA | 33A | 33C | 28.20 | 31.40~34.70 | 1 | 45.7 | 33.3 | 1 |
| 1.5SMC36A | 1.5SMC36CA | 36A | 36C | 30.80 | 34.20~37.80 | 1 | 49.9 | 30.5 | 1 |
| 1.5SMC39A | 1.5SMC39CA | 39A | 39C | 33.30 | 37.10~41.00 | 1 | 53.9 | 28.2 | 1 |

| Part Number | | Device Marking Code | | Reverse Stand-Off Voltage | Breakdown Voltage @ I_T | Test Current | Maximum Clamping Voltage @ I_{PP} | Peak Pulse Current | Reverse Leakage @ V_{RWM} |
|----------------|---------------|---------------------|------|---------------------------|---------------------------|--------------|-------------------------------------|--------------------|-----------------------------|
| Unidirectional | Bidirectional | UNI | BI | $V_{RWM}(V)$ | $V_{BR}(V)$ | $I_T(mA)$ | $V_C(V)$ | $I_{PP}(A)$ | $I_R(\mu A)$ |
| 1.5SMC43A | 1.5SMC43CA | 43A | 43C | 36.80 | 40.90~45.20 | 1 | 59.3 | 25.6 | 1 |
| 1.5SMC47A | 1.5SMC47CA | 47A | 47C | 40.20 | 44.70~49.40 | 1 | 64.8 | 23.5 | 1 |
| 1.5SMC51A | 1.5SMC51CA | 51A | 51C | 43.60 | 48.50~53.60 | 1 | 70.1 | 21.7 | 1 |
| 1.5SMC56A | 1.5SMC56CA | 56A | 56C | 47.80 | 53.20~58.80 | 1 | 77.0 | 19.7 | 1 |
| 1.5SMC62A | 1.5SMC62CA | 62A | 62C | 53.00 | 58.90~65.10 | 1 | 85.0 | 17.9 | 1 |
| 1.5SMC68A | 1.5SMC68CA | 68A | 68C | 58.10 | 64.60~71.40 | 1 | 92.0 | 16.5 | 1 |
| 1.5SMC75A | 1.5SMC75CA | 75A | 75C | 64.10 | 71.30~78.80 | 1 | 103.0 | 14.8 | 1 |
| 1.5SMC82A | 1.5SMC82CA | 82A | 82C | 70.10 | 77.90~86.10 | 1 | 113.0 | 13.5 | 1 |
| 1.5SMC91A | 1.5SMC91CA | 91A | 91C | 77.80 | 86.50~95.50 | 1 | 125.0 | 12.2 | 1 |
| 1.5SMC100A | 1.5SMC100CA | 100A | 100C | 85.50 | 95.00~105.00 | 1 | 137.0 | 11.1 | 1 |
| 1.5SMC110A | 1.5SMC110CA | 110A | 110C | 94.00 | 105.00~116.00 | 1 | 152.0 | 10.0 | 1 |
| 1.5SMC120A | 1.5SMC120CA | 120A | 120C | 102.00 | 114.00~126.00 | 1 | 165.0 | 9.2 | 1 |
| 1.5SMC130A | 1.5SMC130CA | 130A | 130C | 111.00 | 124.00~137.00 | 1 | 179.0 | 8.5 | 1 |
| 1.5SMC150A | 1.5SMC150CA | 150A | 150C | 128.00 | 143.00~158.00 | 1 | 207.0 | 7.3 | 1 |
| 1.5SMC160A | 1.5SMC160CA | 160A | 160C | 136.00 | 152.00~168.00 | 1 | 219.0 | 6.9 | 1 |
| 1.5SMC170A | 1.5SMC170CA | 170A | 170C | 145.00 | 162.00~179.00 | 1 | 234.0 | 6.5 | 1 |
| 1.5SMC180A | 1.5SMC180CA | 180A | 180C | 154.00 | 171.00~189.00 | 1 | 246.0 | 6.2 | 1 |
| 1.5SMC200A | 1.5SMC200CA | 200A | 200C | 171.00 | 190.00~210.00 | 1 | 274.0 | 5.5 | 1 |
| 1.5SMC220A | 1.5SMC220CA | 220A | 220C | 185.00 | 209.00~231.00 | 1 | 328.0 | 4.6 | 1 |
| 1.5SMC250A | 1.5SMC250CA | 250A | 250C | 214.00 | 237.00~263.00 | 1 | 344.0 | 4.4 | 1 |
| 1.5SMC300A | 1.5SMC300CA | 300A | 300C | 256.00 | 285.00~315.00 | 1 | 414.0 | 3.7 | 1 |
| 1.5SMC350A | 1.5SMC350CA | 350A | 350C | 300.00 | 332.00~368.00 | 1 | 482.0 | 3.2 | 1 |
| 1.5SMC400A | 1.5SMC400CA | 400A | 400C | 342.00 | 380.00~420.00 | 1 | 548.0 | 2.8 | 1 |
| 1.5SMC440A | 1.5SMC440CA | 440A | 440C | 376.00 | 418.00~462.00 | 1 | 602.0 | 2.5 | 1 |
| 1.5SMC480A | 1.5SMC480CA | 480A | 480C | 408.00 | 456.00~504.00 | 1 | 658.0 | 2.3 | 1 |
| 1.5SMC510A | 1.5SMC510CA | 510A | 510C | 434.00 | 485.00~535.00 | 1 | 698.0 | 2.1 | 1 |
| 1.5SMC530A | 1.5SMC530CA | 530A | 530C | 450.00 | 503.50~556.50 | 1 | 725.0 | 2.1 | 1 |
| 1.5SMC540A | 1.5SMC540CA | 540A | 540C | 459.00 | 513.00~567.00 | 1 | 740.0 | 2.0 | 1 |
| 1.5SMC550A | 1.5SMC550CA | 550A | 550C | 467.00 | 522.50~577.50 | 1 | 760.0 | 2.0 | 1 |

Notes: For bidirectional type having V_{RWM} of 10V and less, the I_R limit is double.

Ratings and Characteristic Curves ($T_A=25^\circ\text{C}$ unless otherwise noted)

Figure 1. Peak Pulse Power Rating Curve

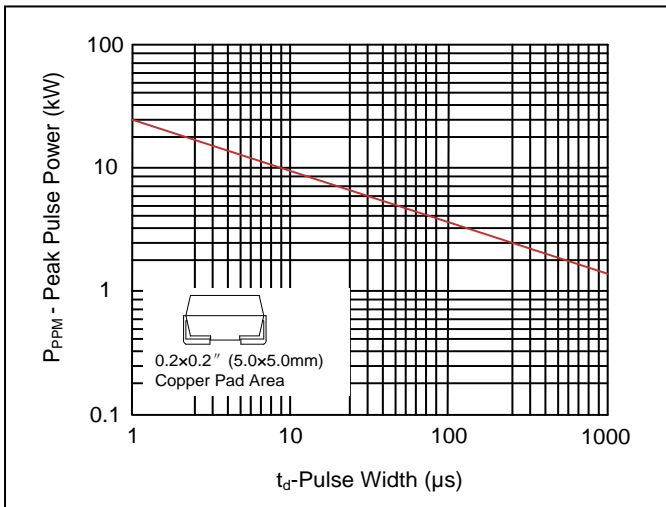

Figure 2. Pulse Derating Curve

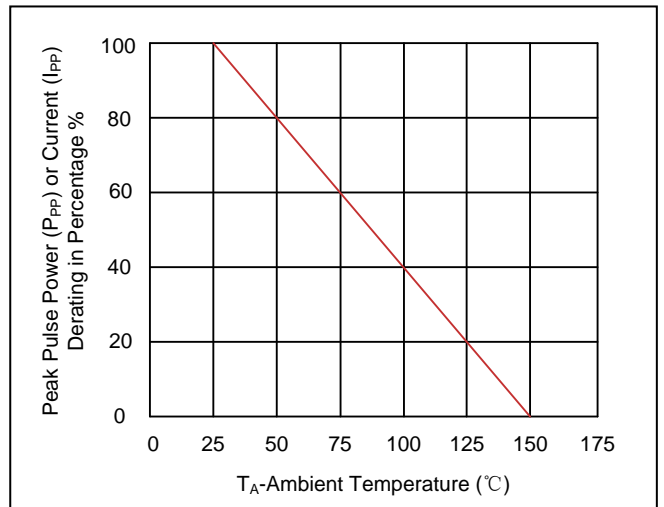

Figure 3. Pulse Waveform

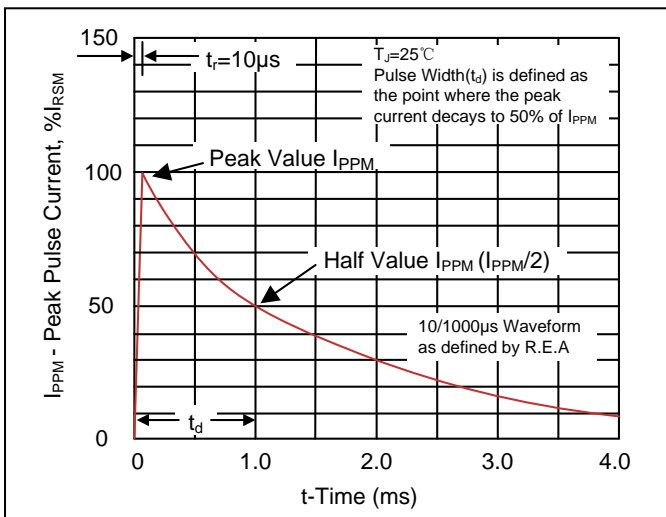

Figure 4. Typical Junction Capacitance

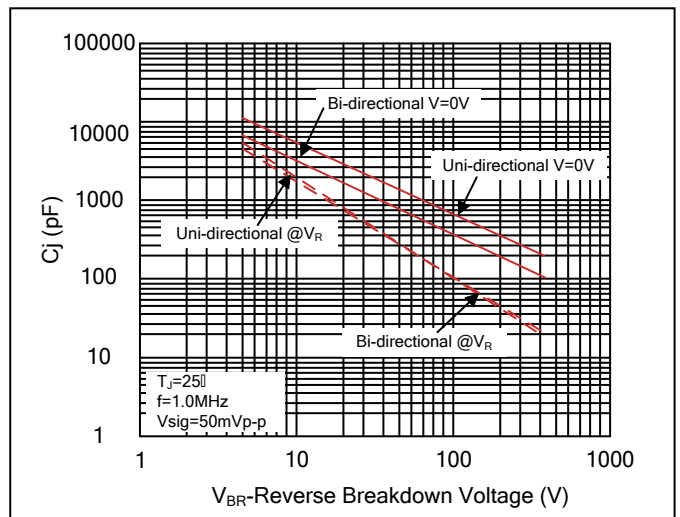

Figure 5. Steady State Power Dissipation Derating Curve

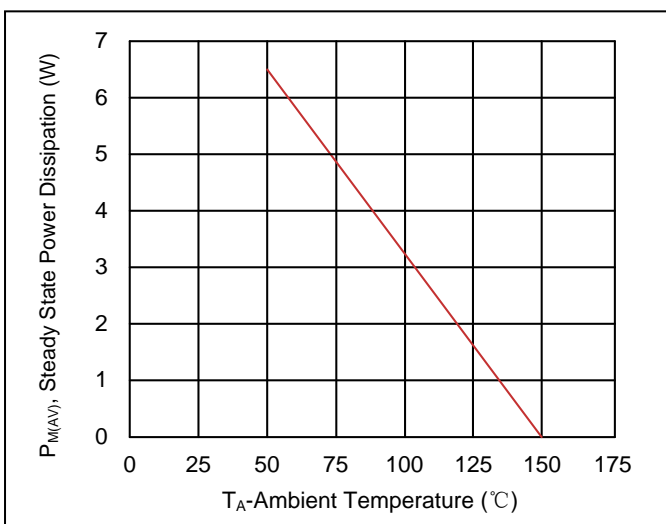
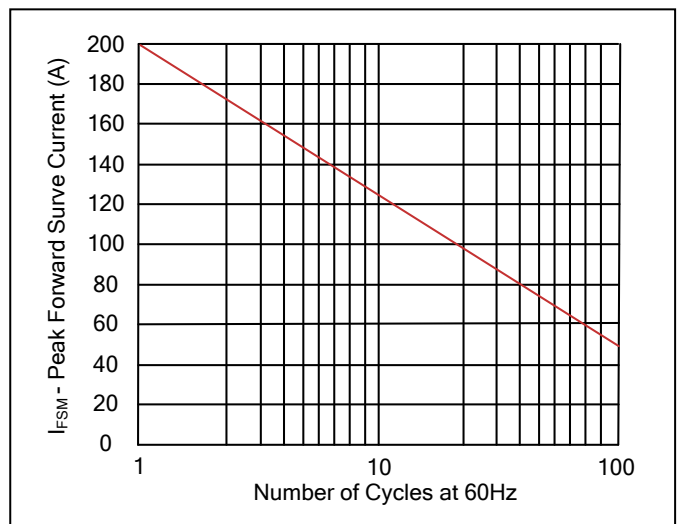
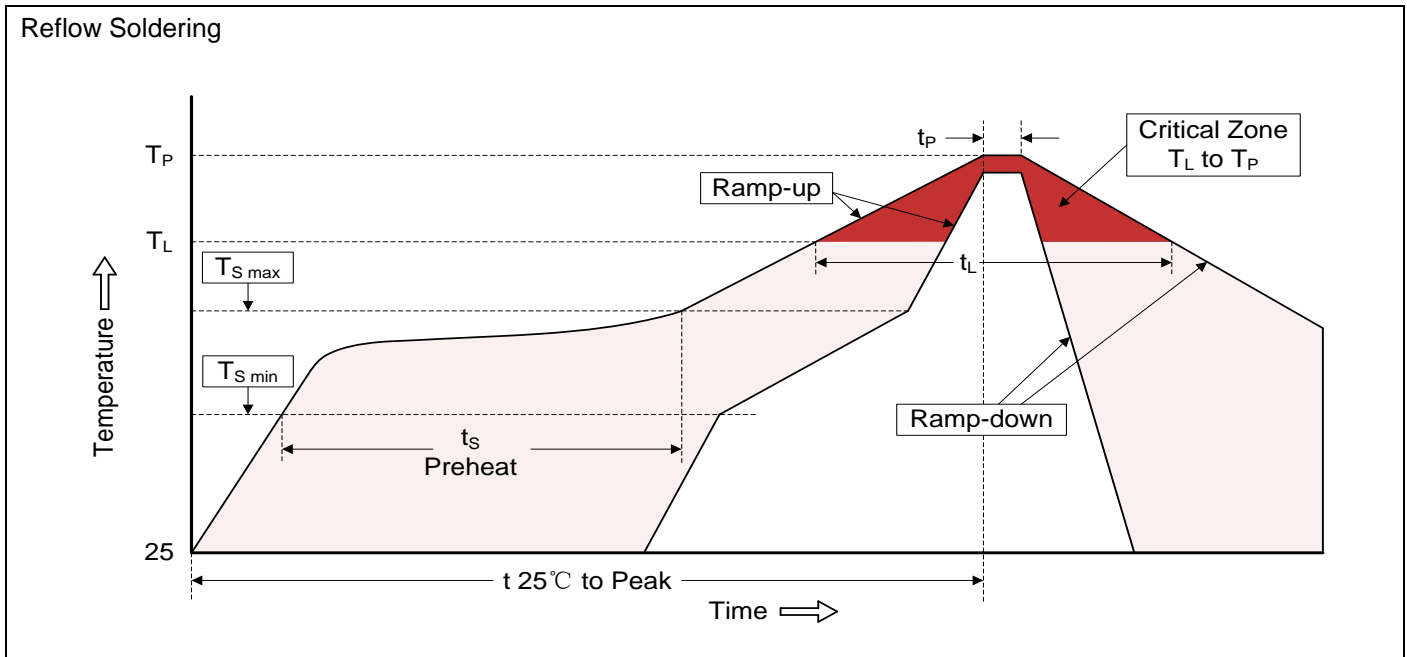

Figure 6. Maximum Non-Repetitive Forward Surge Current Uni-Directional Only



Recommended Soldering Conditions



Recommended Conditions

| Profile Feature | Pb-Free Assembly |
|---|----------------------------------|
| Average ramp-up rate (T_L to T_P) | 3°C/second max. |
| Preheat -Temperature Min ($T_{S\ min}$) -Temperature Max ($T_{S\ max}$) -Time (min to max) (t_s) | 150°C 200°C 60-180 seconds |
| $T_{S\ max}$ to T_L -Ramp-up Rate | 3°C/second max. |
| Time maintained above: -Temperature (T_L) -Time (t_L) | 217°C 60-150 seconds |
| Peak Temperature (T_P) | 260°C |
| Time within 5°C of actual Peak Temperature (t_p) | 20-40 seconds |
| Ramp-down Rate | 6°C/second max. |
| Time 25°C to Peak Temperature | 8 minutes max. |

Marking Code

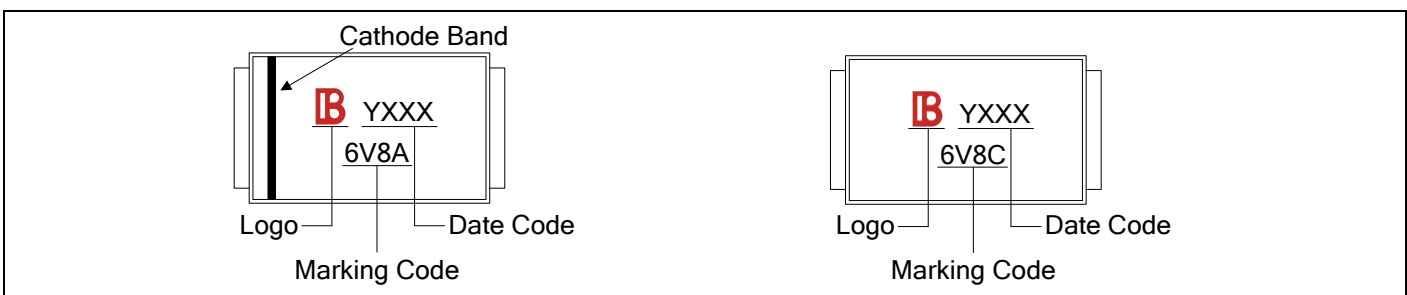

Part Number Code

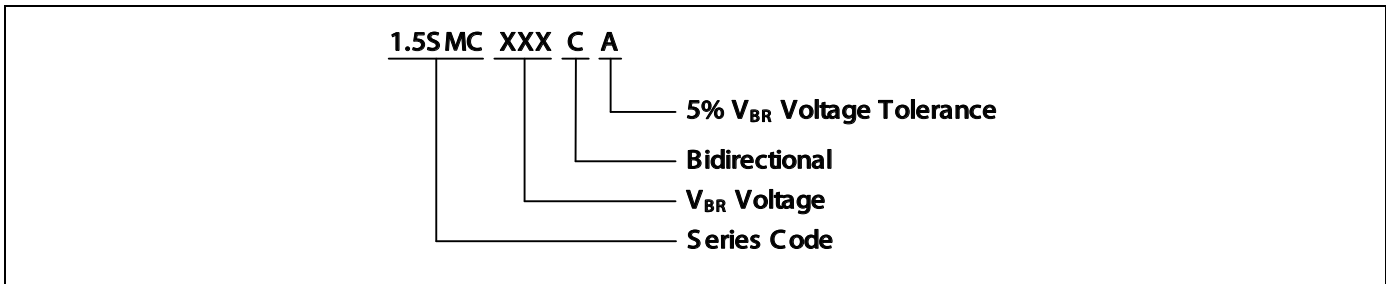

Ordering Code for Different Package

7 inch reel package: Add suffix “/TR7” at the end of the part number, such as 1.5SMC47A/TR7

13 inch reel package: Add suffix “/TR13” at the end of the part number, such as 1.5SMC250CA/TR13

Packaging

| Tape | | Symbol | Dimension (mm) |
|------------------|-----------|-------------------|----------------|
| | | W | 16.00±0.20 |
| | | P0 | 4.00±0.10 |
| | | P1 | 8.00±0.10 |
| | | P2 | 2.00±0.10 |
| | | D0 | Φ1.5±0.10 |
| | | D1 | Φ1.5±0.10 |
| | | E | 1.75±0.10 |
| | | F | 7.50±0.10 |
| | | A0 | 6.27±0.15 |
| | | B0 | 8.30±0.10 |
| | | K0 | 3.15±0.15 |
| | | T | 0.30±0.05 |
| | | D2 | Φ178.0±2.0 |
| | | D3 | Φ50.0Min. |
| D4 | Φ13.0±0.5 | | |
| W1 | 20.0±2.0 | | |
| Quantity: 500PCS | | | |
| 7" Reel | | D5 | Φ330.0±2.0 |
| | | D6 | Φ13.5±0.5 |
| | | H | 2.5±1.0 |
| | | W2 | 20.0±2.0 |
| | | Quantity: 3000PCS | |
| 13" Reel | | | |

X-ON Electronics

Largest Supplier of Electrical and Electronic Components

Click to view similar products for [ESD Suppressors / TVS Diodes](#) category:

Click to view products by [Brightking](#) manufacturer:

Other Similar products are found below :

[NTE4902](#) [P4SMAJ15A](#) [P4SMAJ26A](#) [SMAJ400CA-TP](#) [TGL34-47CA](#) [ESDAULC45-1BF4](#) [SM1605E3/TR13](#) [SMF20A-TP](#) [P4SMAJ12A](#)
[CPDUR24V-HF](#) [CPDQC5V0USP-HF](#) [CPDQC5V0-HF](#) [MPLAD30KP280A](#) [MPLAD30KP45CAE3](#) [MMBZ27VCLQ-7-F](#) [MMAD1108/TR13](#)
[MPLAD30KP24A](#) [MPLAD30KP30CAE3](#) [ACPDQC5V0R-HF](#) [DFLT170A-7](#) [NTE4900](#) [NTE4926](#) [NTE4938](#) [JANTX1N6144A](#)
[JANTX1N6057A](#) [SMF22A-TP](#) [SMF12A-TP](#) [SLVU2.8-TP](#) [SMLJ6.5CA-TP](#) [SMAJ6.5CA-TP](#) [MMAD1108E3/TR13](#) [JANTX1N6160A](#)
[D5V0M1U2LP3-7](#) [SMAJ400A-TP](#) [AOZ8811DT-03](#) [AOZ8831DI-05](#) [AOZ8831DT-03](#) [SMAJ188CA](#) [3SMC33CA BK](#) [CPDQC3V3C-HF](#)
[CPDQC12VE-HF](#) [GRPADATAJANTX1N6041A](#) [MPLAD30KP170CA](#) [82357120100](#) [5.0SMLJ15CA-TP](#) [5KP18A-TP](#) [P6KE8.2A-TP](#)
[MPLAD30KP43CAE3](#) [SMAJ43A-TP](#) [D26V0H1U2LP16-7](#)