

Metal Oxide Varistor (MOV) Data Sheet

Features

- Wide operating voltage (V_{1mA}) range from 18V to 1800V
- Fast responding to transient over-voltage
- Large absorbing transient energy capability
- Low clamping ratio and no follow-on current
- Meets MSL level 1, per J-STD-020
- Operating Temperature : $-40^{\circ}\text{C} \sim +105^{\circ}\text{C}$
- Storage Temperature : $-40^{\circ}\text{C} \sim +125^{\circ}\text{C}$
- Safety certification: UL: E327997
CSA: 246579
VDE: 40027827



Applications

- Transistor, diode, IC, thyristor or triac semiconductor protection
- Surge protection in consumer electronics
- Surge protection in industrial electronics
- Surge protection in electronic home appliances, gas and petroleum appliances
- Relay and electromagnetic valve surge absorption

Part Number Code

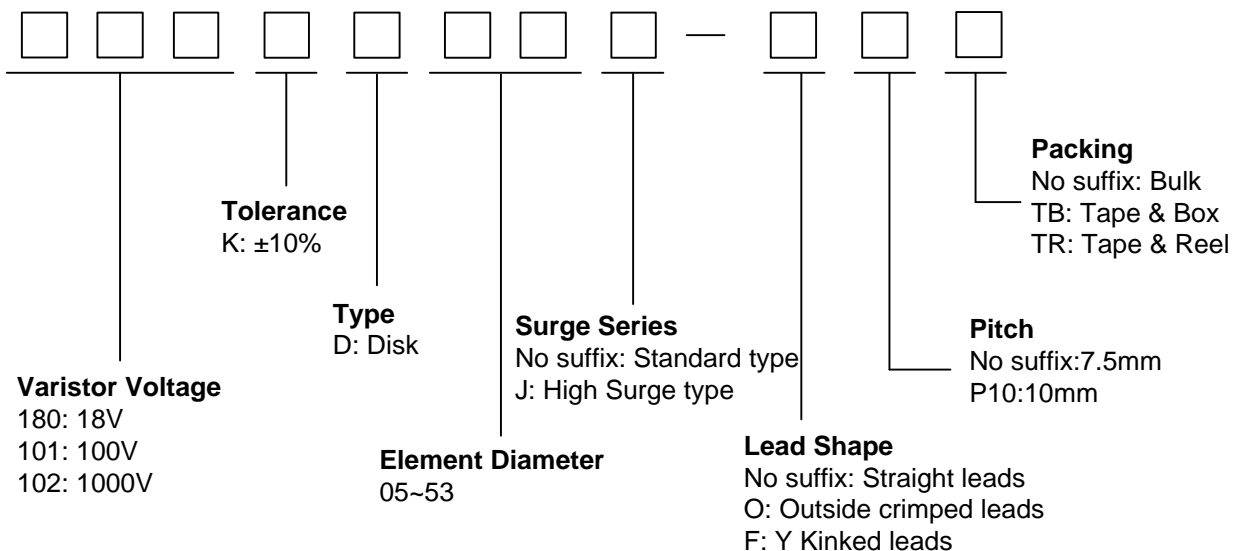

Dimensions

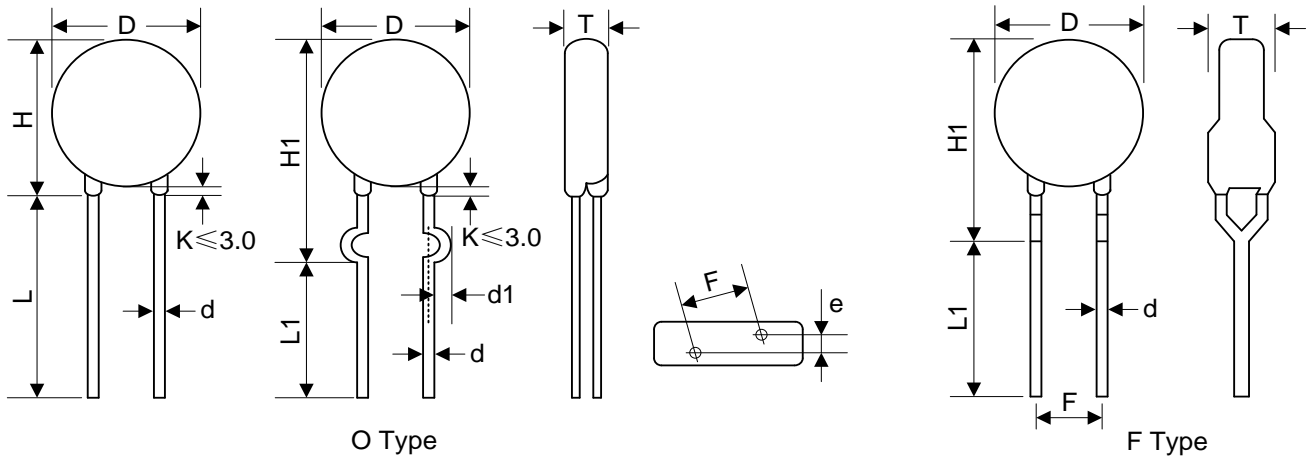

Notes: Varistor voltage ≥ 1200V, structure diagram is F type.

Table 1	
Unit: mm	
Symbol	Dimension
H	14.5~20.0
H1	17.0~21.0
L(min.)	20.0
L1(min.)	15.0
D	14.0~16.5
F(±0.8)	7.5
T	Table 2
e(±0.8)	Table 2
d(±0.05)	0.8
d1(±0.4)	1.4

Table 2					
Unit: mm					
Model	T	e	Model	T	e
180K	2.0~3.9	1.5	361K	2.9~5.2	2.7
220K	2.1~4.0	1.6	391K	3.0~5.4	2.8
270K	2.1~4.1	1.8	431K	3.2~5.6	3.0
330K	2.2~4.3	1.7	471K	3.3~5.8	3.2
390K	2.1~4.1	1.8	511K	3.4~6.1	3.4
470K	2.2~4.3	1.9	561K	3.6~6.4	3.6
560K	2.3~4.6	2.1	621K	3.8~6.8	3.9
680K	2.4~4.8	2.4	681K	4.0~7.1	4.2
820K	2.1~4.1	1.8	751K	4.3~7.2	4.3
101K	2.4~4.2	2.0	781K	4.4~7.3	4.4
121K	2.4~4.4	2.2	821K	4.6~7.5	4.6
151K	2.2~4.1	1.8	911K	4.8~7.5	5.0
181K	2.3~4.2	1.9	102K	5.4~8.0	5.0
201K	2.4~4.3	2.0	112K	5.8~8.5	5.4
221K	2.5~4.4	2.1	122K	5.9~9.0	5.8
241K	2.6~4.5	2.2	142K	6.9~10.5	6.6
271K	2.6~4.6	2.4	162K	7.4~11.0	7.4
301K	2.7~4.6	2.5	182K	7.6~12.0	8.2
331K	2.7~5.0	2.5			

Electrical Characteristics

Part Number		Maximum Allowable Voltage		Varistor Voltage	Maximum Clamping Voltage		Withstanding Surge Current		Maximum Energy (10/1000μs)		Rated Power	Typical Capacitance (Reference)
Standard	High Surge	V _{AC} (V)	V _{DC} (V)	V _{1mA} (V)	I _P (A)	V _C (V)	I (A) Standard	I (A) High Surge	(J) Standard	(J) High Surge	(W)	@1KHz (pf)
180KD14	180KD14J	11	14	18(15~21.6)	10	36	1000	2000	4.0	7.0	0.1	11100
220KD14	220KD14J	14	18	22(19.5~26)	10	43	1000	2000	5.0	8.0	0.1	9100
270KD14	270KD14J	17	22	27(24~31)	10	53	1000	2000	6.0	10.0	0.1	7400
330KD14	330KD14J	20	26	33(29.5~36.5)	10	65	1000	2000	7.5	12.0	0.1	6100
390KD14	390KD14J	25	31	39(35~43)	10	77	1000	2000	8.6	13.0	0.1	5100
470KD14	470KD14J	30	38	47(42~52)	10	93	1000	2000	10.0	17.0	0.1	4300
560KD14	560KD14J	35	45	56(50~62)	10	110	1000	2000	11.0	20.0	0.1	3600
680KD14	680KD14J	40	56	68(61~75)	10	135	1000	2000	14.0	24.0	0.1	2900
820KD14	820KD14J	50	65	82(74~90)	50	135	4500	6000	22.0	27.0	0.6	2400
101KD14	101KD14J	60	85	100(90~110)	50	165	4500	6000	28.0	33.0	0.6	2000
121KD14	121KD14J	75	100	120(108~132)	50	200	4500	6000	32.0	40.0	0.6	1700
151KD14	151KD14J	95	125	150(135~165)	50	250	4500	6000	40.0	53.0	0.6	1300
181KD14	181KD14J	115	150	180(162~198)	50	300	4500	6000	50.0	60.0	0.6	1100
201KD14	201KD14J	130	170	200(180~220)	50	340	4500	6000	57.0	70.0	0.6	1000
221KD14	221KD14J	140	180	220(198~242)	50	360	4500	6000	60.0	78.0	0.6	900
241KD14	241KD14J	150	200	240(216~264)	50	395	4500	6000	63.0	84.0	0.6	830
271KD14	271KD14J	175	225	270(243~297)	50	455	4500	6000	70.0	99.0	0.6	740
301KD14	301KD14J	190	250	300(270~330)	50	500	4500	6000	77.0	108	0.6	670
331KD14	331KD14J	210	275	330(297~363)	50	550	4500	6000	85.0	115	0.6	610
361KD14	361KD14J	230	300	360(324~396)	50	595	4500	6000	93.0	130	0.6	560
391KD14	391KD14J	250	320	390(351~429)	50	650	4500	6000	100	140	0.6	510
431KD14	431KD14J	275	350	430(387~473)	50	710	4500	6000	115	155	0.6	460
471KD14	471KD14J	300	385	470(423~517)	50	775	4500	6000	118	175	0.6	430
511KD14	511KD14J	320	415	510(459~561)	50	845	4500	6000	121	180	0.6	390
561KD14	561KD14J	350	460	560(504~616)	50	925	4500	6000	125	185	0.6	360
621KD14	621KD14J	385	505	620(558~682)	50	1025	4500	6000	128	190	0.6	320
681KD14	681KD14J	420	560	680(612~748)	50	1120	4500	6000	130	200	0.6	290
751KD14	751KD14J	460	615	750(675~825)	50	1240	4500	6000	143	210	0.6	270
781KD14	781KD14J	485	640	780(702~858)	50	1290	4500	6000	148	220	0.6	260
821KD14	821KD14J	510	670	820(738~902)	50	1355	4500	6000	157	235	0.6	240
911KD14	911KD14J	550	745	910(819~1001)	50	1500	4500	6000	175	255	0.6	220
102KD14	102KD14J	625	825	1000(900~1100)	50	1650	4500	6000	190	280	0.6	200
112KD14	112KD14J	680	895	1100(990~1210)	50	1815	4500	6000	213	310	0.6	180
122KD14	122KD14J	750	990	1200(1080~1320)	50	1980	4500	6000	232	324	0.6	160
142KD14	142KD14J	880	1140	1400(1260~1540)	50	2310	4500	6000	238	327	0.6	150

Part Number		Maximum Allowable Voltage		Varistor Voltage	Maximum Clamping Voltage		Withstanding Surge Current		Maximum Energy (10/1000μs)		Rated Power	Typical Capacitance (Reference)
Standard	High Surge	V _{AC} (V)	V _{DC} (V)	V _{1mA} (V)	I _P (A)	V _C (V)	I (A) Standard	I (A) High Surge	(J) Standard	(J) High Surge	(W)	@1KHz (pf)
162KD14	162KD14J	1000	1280	1600(1440~1760)	50	2640	4500	6000	243	331	0.6	140
182KD14	182KD14J	1100	1465	1800(1620~1980)	50	2970	4500	5000	250	335	0.6	130

- Notes: 1. The tolerance of varistor voltage between 18V and 27V is more than 10%;
 2. Varistor voltage ≥ 1200V, structure diagram is F type;
 3. Leakage Current (@83% of V_{1mA}) : IR ≤ 50μA (180K~680K) ; IR ≤ 25μA (820K~182K).

Electrical Ratings

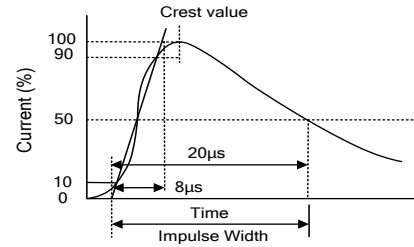
Items	Test Condition/Description	Requirement					
Varistor Voltage	The voltage between the two terminals with the specified measuring current 1mA.DC applied is called V _b .	To meet the Specified value					
Maximum Allowable Voltage	The recommended maximum sine wave voltage (RMS) or the Maximum DC voltage can be applied continuously.						
Maximum Clamping Voltage	The maximum voltage between the two terminals with the specification standard impulse current. Applied waveform: 8/20μs 						
Rated Wattage	The maximum average power that can be applied within the specified ambient temperature.						
Energy	The maximum energy within the varistor voltage change of ±10% when one impulse of 10/1000μs or 2ms is applied.						
Withstanding Surge Current	The maximum current within the varistor voltage change of ±10% with the standard impulse current (8/20μs) applied one time.						
Varistor Voltage Temp. Coefficient	$\left \frac{V_{1mA@105^{\circ}C} - V_{1mA@25^{\circ}C}}{V_{1mA@25^{\circ}C}} \times \frac{1}{80} \times 100\% (\%/^{\circ}C) \right $ $\left \frac{V_{1mA@-40^{\circ}C} - V_{1mA@25^{\circ}C}}{V_{1mA@25^{\circ}C}} \times \frac{1}{65} \times 100\% (\%/^{\circ}C) \right $		≤0.05%/°C				
Surge Life	The change of V _b shall be measured after the impulse listed below which is applied 10,000 times continuously with the interval of ten seconds at room temperature. <table border="1" style="margin-left: auto; margin-right: auto;"> <tr> <td rowspan="2">14Φ series</td> <td>180K to 680K</td> <td>75A (8/20μs)</td> </tr> <tr> <td>820K to 182K</td> <td>150A (8/20μs)</td> </tr> </table>	14Φ series	180K to 680K	75A (8/20μs)	820K to 182K	150A (8/20μs)	$\frac{\Delta V_b}{V_b} \leq \pm 10\%$
14Φ series	180K to 680K		75A (8/20μs)				
	820K to 182K	150A (8/20μs)					

Soldering Recommendation

Lead-free Wave Soldering Recommendation

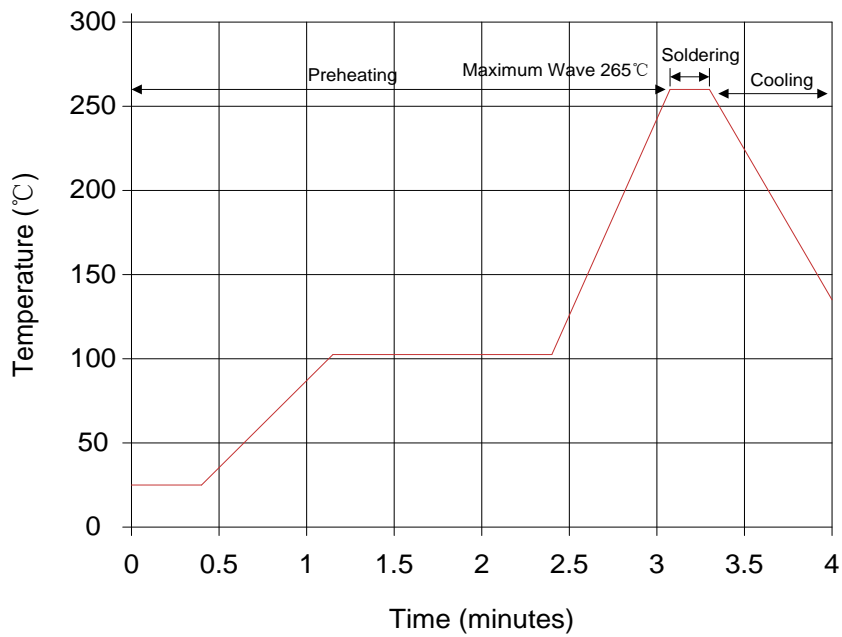

Item	Conditions
Peak Temperature	265°C
Dipping Time	10 seconds (max.)
Soldering	1 time

Recommendation Reworking Conditions with Soldering Iron

Item	Conditions
Temperature of Soldering Iron-tip	360°C (max.)
Soldering Time	3 seconds (max.)
Distance from Varistor	2mm (min.)

Mechanical Characteristics

Items	Test conditions / Methods	Specifications								
Tensile Strength of Terminals	Gradually applying the force specified and keeping the unit fixed for 10±1 sec. <table border="1" style="margin-left: auto; margin-right: auto;"> <thead> <tr> <th>Terminal diameter (mm)</th> <th>Force (kg)</th> </tr> </thead> <tbody> <tr> <td>0.5<d≤0.8</td> <td>1.0</td> </tr> <tr> <td>0.8<d≤1.25</td> <td>2.0</td> </tr> <tr> <td>1.25<d</td> <td>4.0</td> </tr> </tbody> </table>	Terminal diameter (mm)	Force (kg)	0.5<d≤0.8	1.0	0.8<d≤1.25	2.0	1.25<d	4.0	No visible damage ΔV _{1mA} /V _{1mA} ≤5%
Terminal diameter (mm)	Force (kg)									
0.5<d≤0.8	1.0									
0.8<d≤1.25	2.0									
1.25<d	4.0									
Bending Strength of Terminals	Hold specimen and apply the force specified below to each lead. Bend the specimen to 90°, then return to the original position. Repeat the procedure in the opposite direction. <table border="1" style="margin-left: auto; margin-right: auto;"> <thead> <tr> <th>Terminal diameter (mm)</th> <th>Force (kg)</th> </tr> </thead> <tbody> <tr> <td>0.5<d≤0.8</td> <td>0.5</td> </tr> <tr> <td>0.8<d≤1.25</td> <td>1.0</td> </tr> <tr> <td>1.25<d</td> <td>2.0</td> </tr> </tbody> </table>	Terminal diameter (mm)	Force (kg)	0.5<d≤0.8	0.5	0.8<d≤1.25	1.0	1.25<d	2.0	No visible damage ΔV _{1mA} /V _{1mA} ≤5%
Terminal diameter (mm)	Force (kg)									
0.5<d≤0.8	0.5									
0.8<d≤1.25	1.0									
1.25<d	2.0									
Vibration	Frequency range: 10~55 Hz Amplitude: 0.75mm or 98m/s ² Direction: 3 mutually perpendicular directions, 2hrs each.	No visible damage ΔV _{1mA} /V _{1mA} ≤5%								
Solder ability	Solder Temp: 245±5°C Dipping Time: 2±0.5 sec	At least 95% of terminal electrode is covered by new solder								
Resistance to Soldering Heat	Solder Temp: 260±5°C Dipping Time: 10±1 sec	No visible damage ΔV _{1mA} /V _{1mA} ≤10%								

Reliability

Items	Test conditions / Methods	Specifications															
High Temperature Storage	Ambient Temp: 125±2°C Duration: 1000hrs	ΔV _{1mA} /V _{1mA} ≤5%															
Low Temperature Storage	Ambient Temp: -40±2°C Duration: 1000hrs	ΔV _{1mA} /V _{1mA} ≤5%															
Humidity	Ambient Temp: 40±2°C, 90~95% R.H. Duration: 1000hrs	ΔV _{1mA} /V _{1mA} ≤5%															
Temperature Cycle	The conditions shown below shall be repeated 5 cycles <table border="1" style="margin-left: auto; margin-right: auto;"> <thead> <tr> <th>Step</th> <th>Temperature (°C)</th> <th>Period (minutes)</th> </tr> </thead> <tbody> <tr> <td>1</td> <td>-40±3</td> <td>30±3</td> </tr> <tr> <td>2</td> <td>Room temperature</td> <td>15±3</td> </tr> <tr> <td>3</td> <td>125±3</td> <td>30±3</td> </tr> <tr> <td>4</td> <td>Room temperature</td> <td>15±3</td> </tr> </tbody> </table>	Step	Temperature (°C)	Period (minutes)	1	-40±3	30±3	2	Room temperature	15±3	3	125±3	30±3	4	Room temperature	15±3	No visible damage ΔV _{1mA} /V _{1mA} ≤5%
Step	Temperature (°C)	Period (minutes)															
1	-40±3	30±3															
2	Room temperature	15±3															
3	125±3	30±3															
4	Room temperature	15±3															
High Temperature Load	Ambient Temp: 105±2°C Duration: 1000hrs Load: Max. Allowable Voltage In AC eara.	ΔV _{1mA} /V _{1mA} ≤10%															
Damp Heat Load	Ambient Temp: 40±2°C, 90~95% R.H. Duration: 1000hrs Load: Max. Allowable Voltage	No visible damage ΔV _{1mA} /V _{1mA} ≤10%															
Voltage Proof	Metal balls method, 2500Vac 1 min.	No visible damage															

Maximum Surge Current Derating Curve

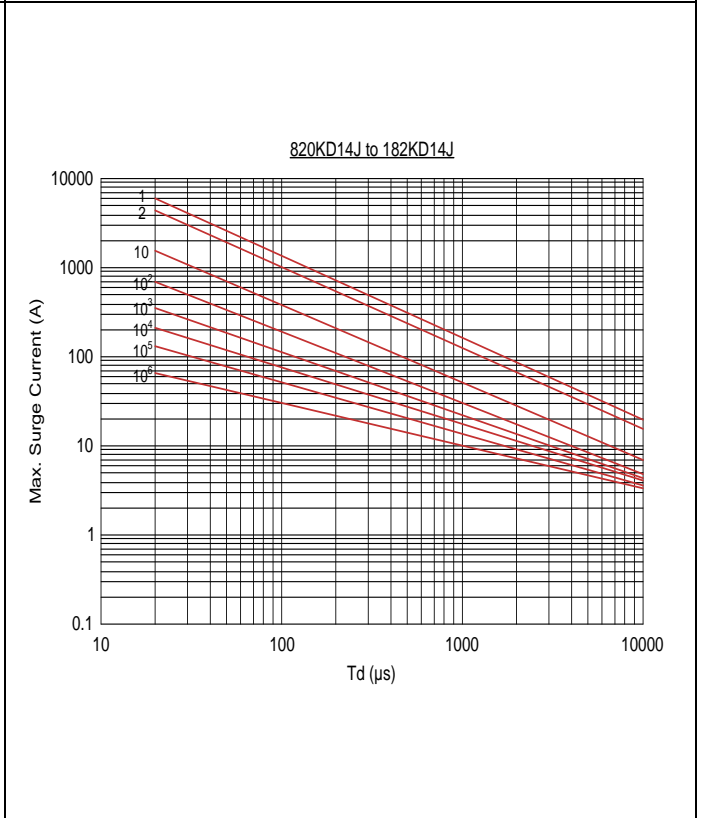
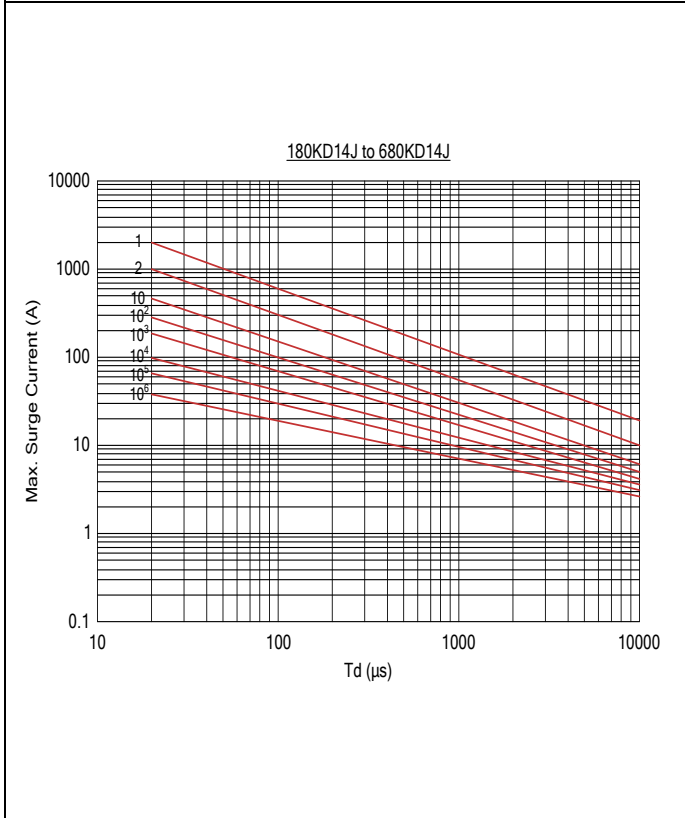
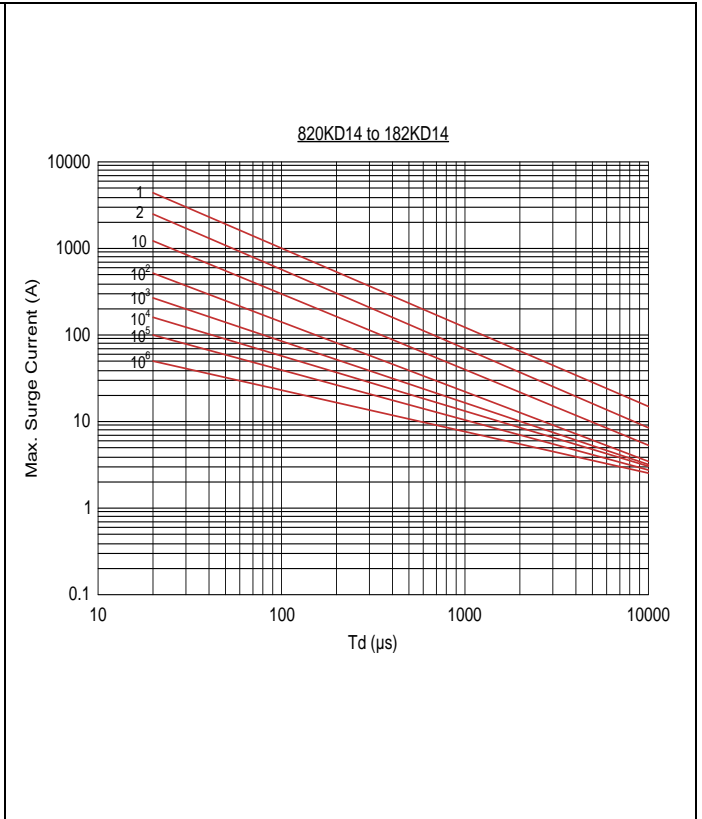
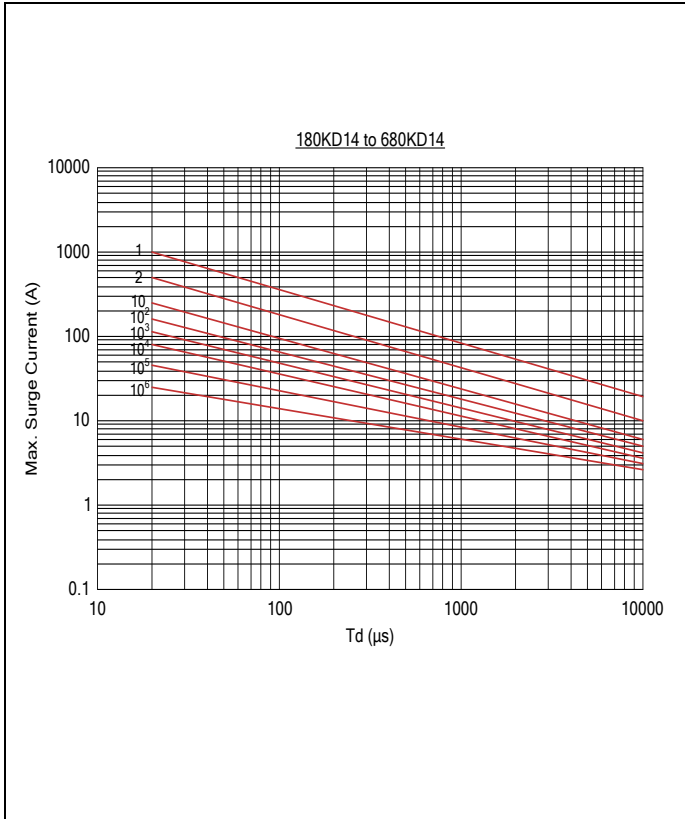

Maximum Leakage Current and Maximum Clamping Voltage Curve

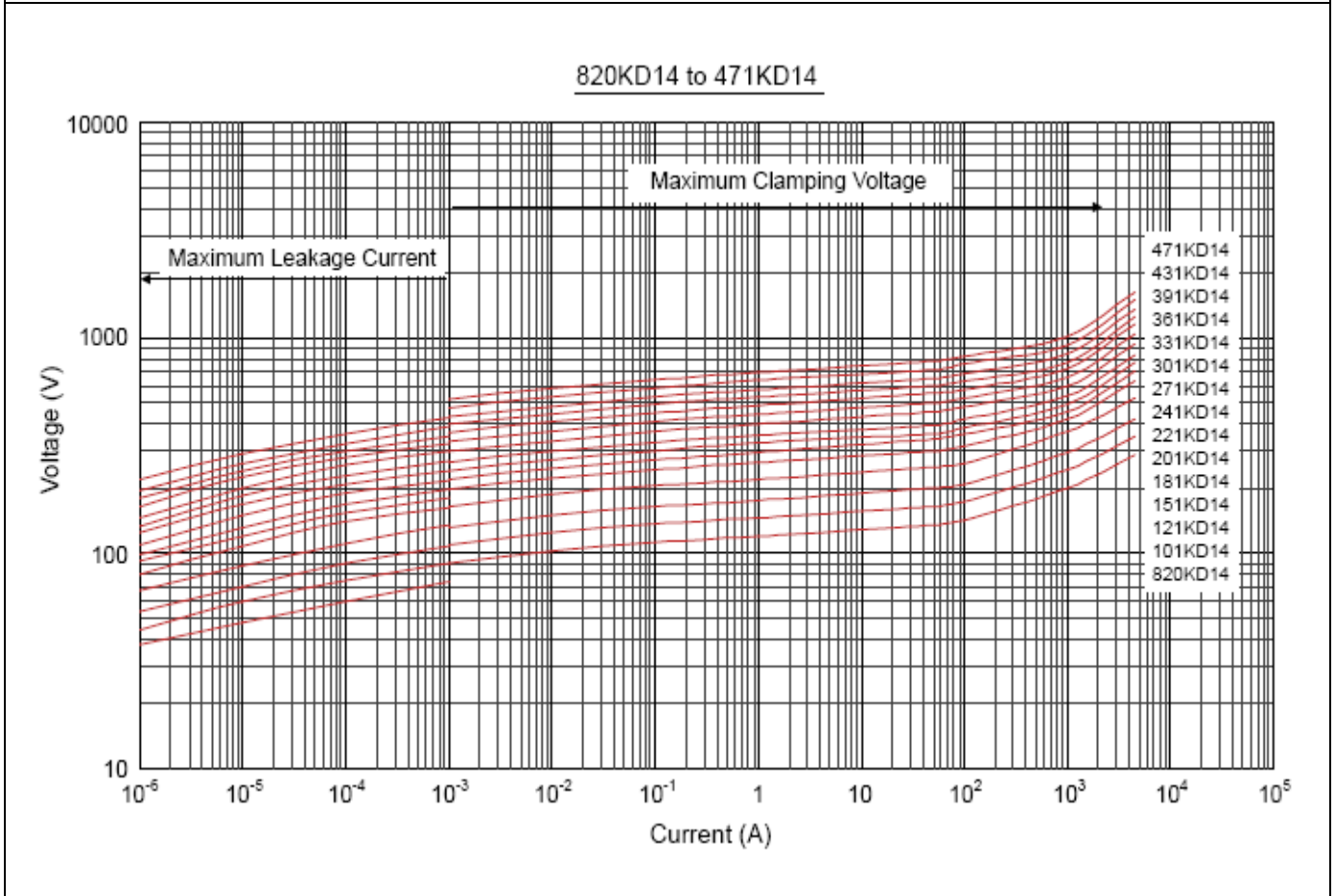
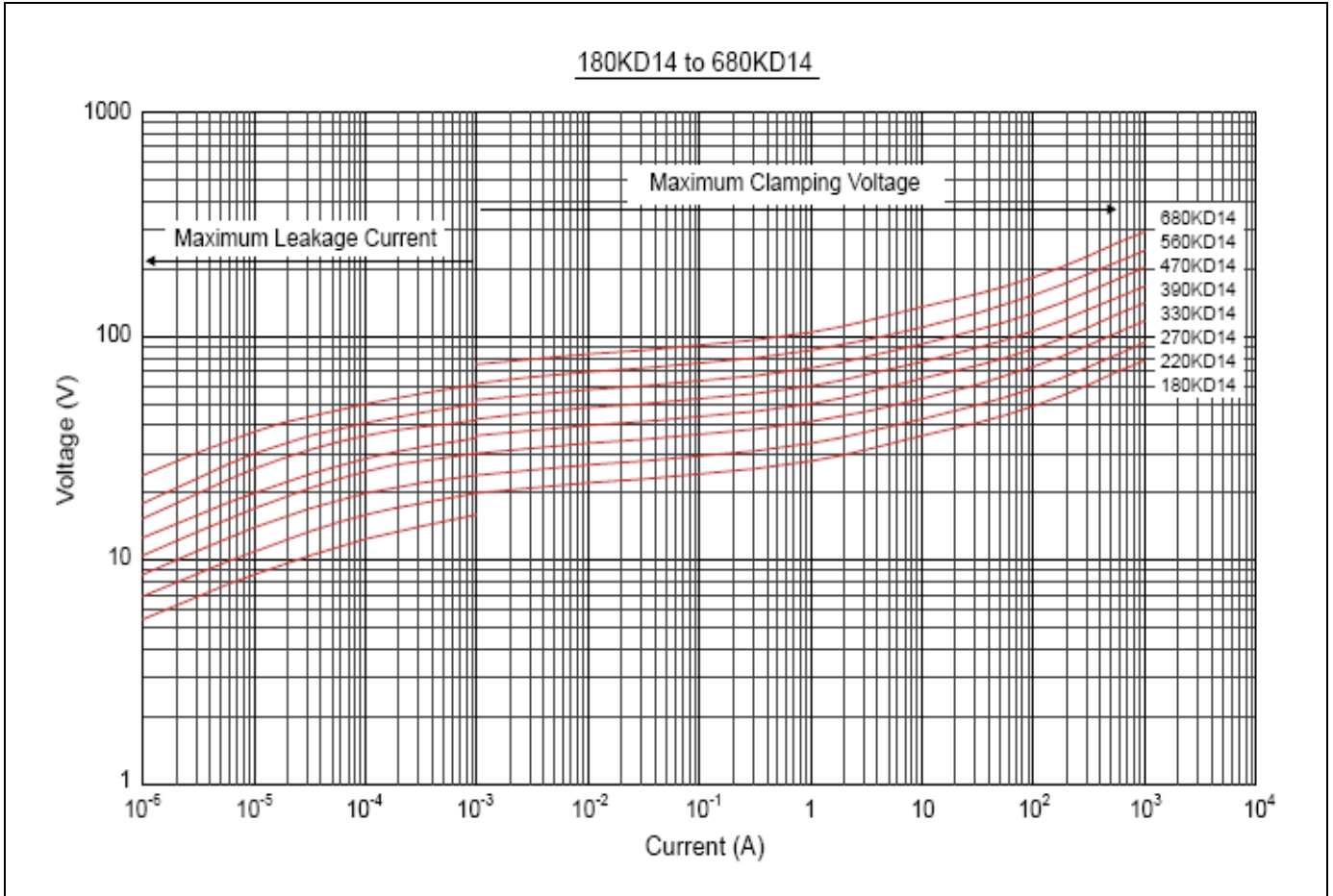

Maximum Leakage Current and Maximum Clamping Voltage Curve

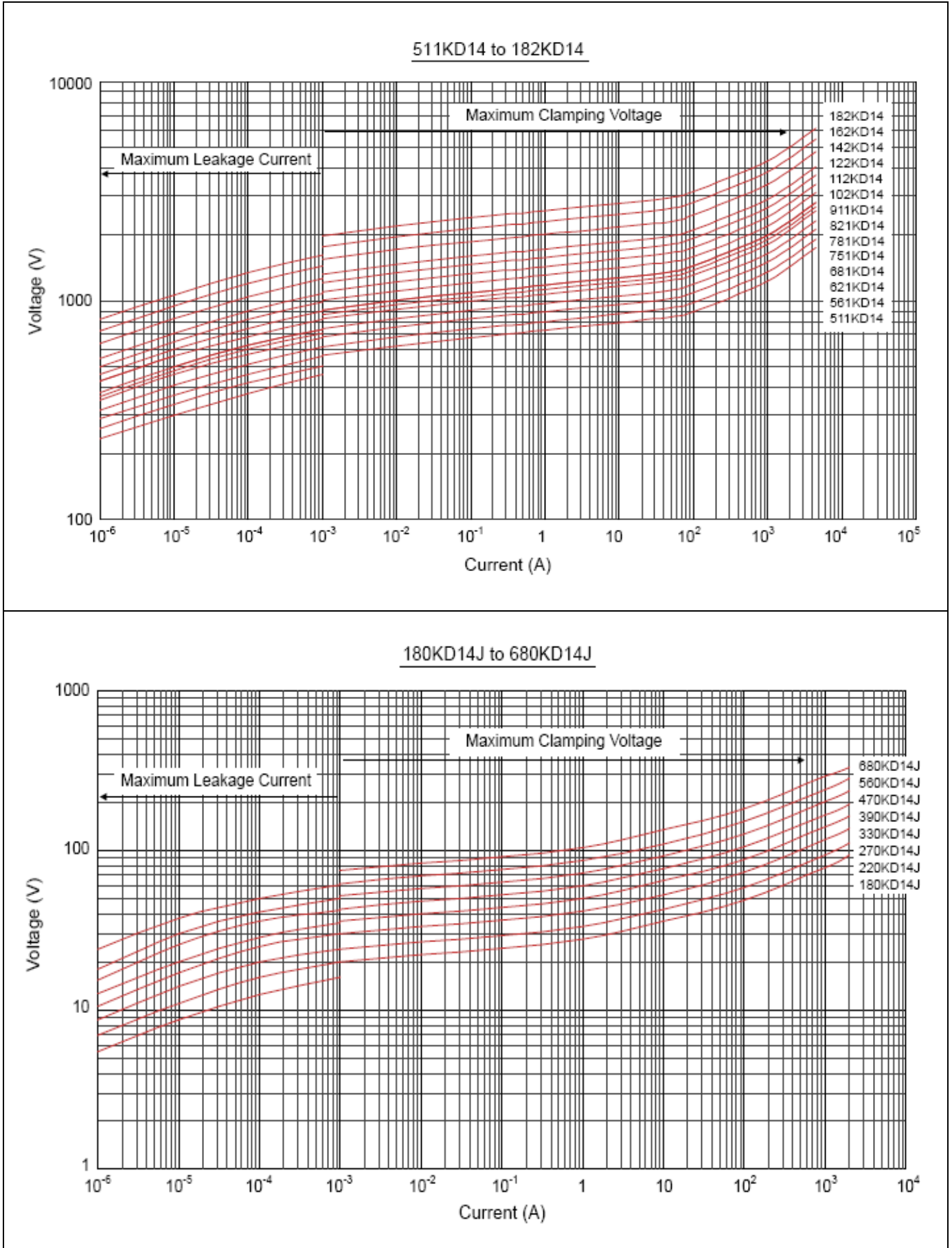

Maximum Leakage Current and Maximum Clamping Voltage Curve

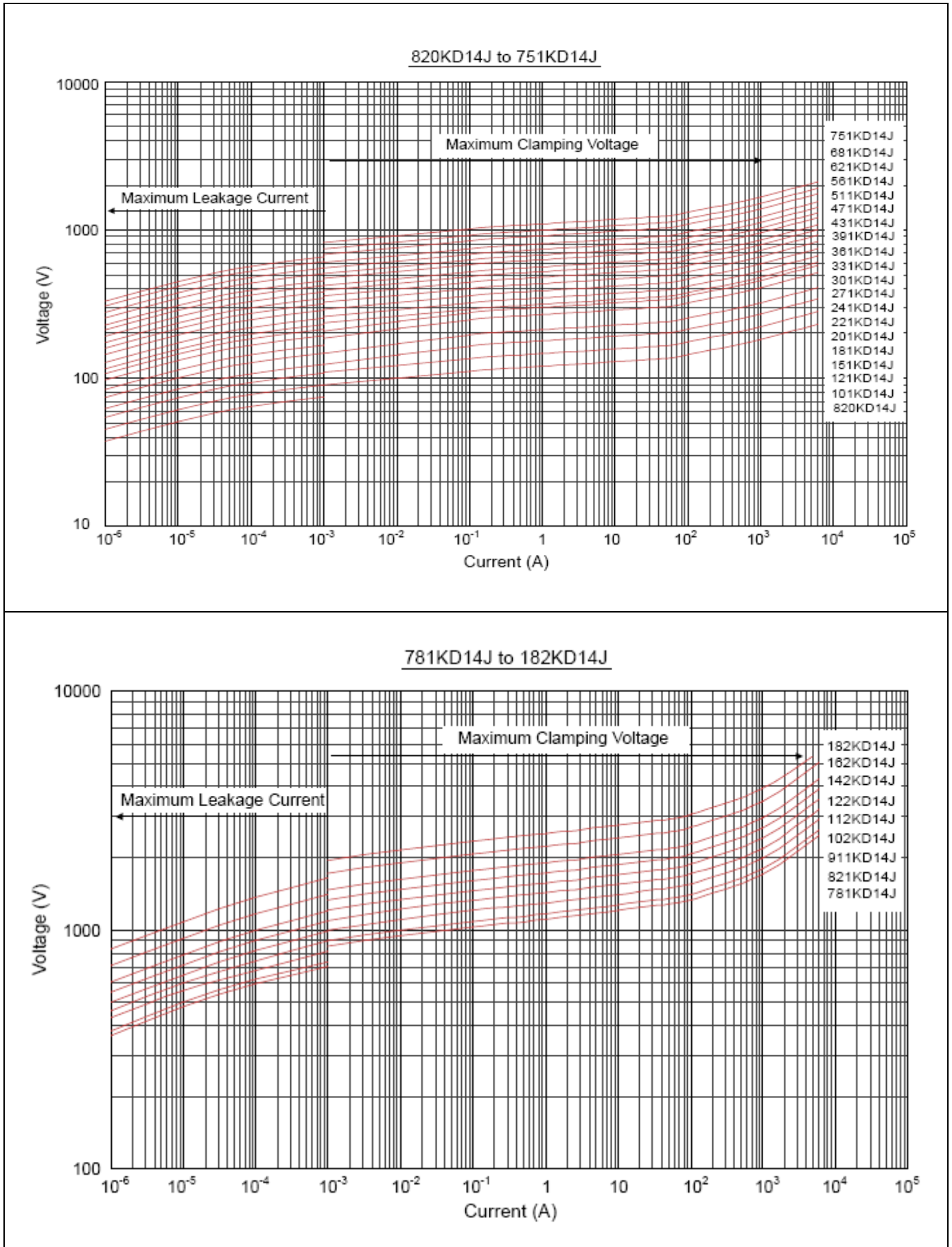

Marking Code

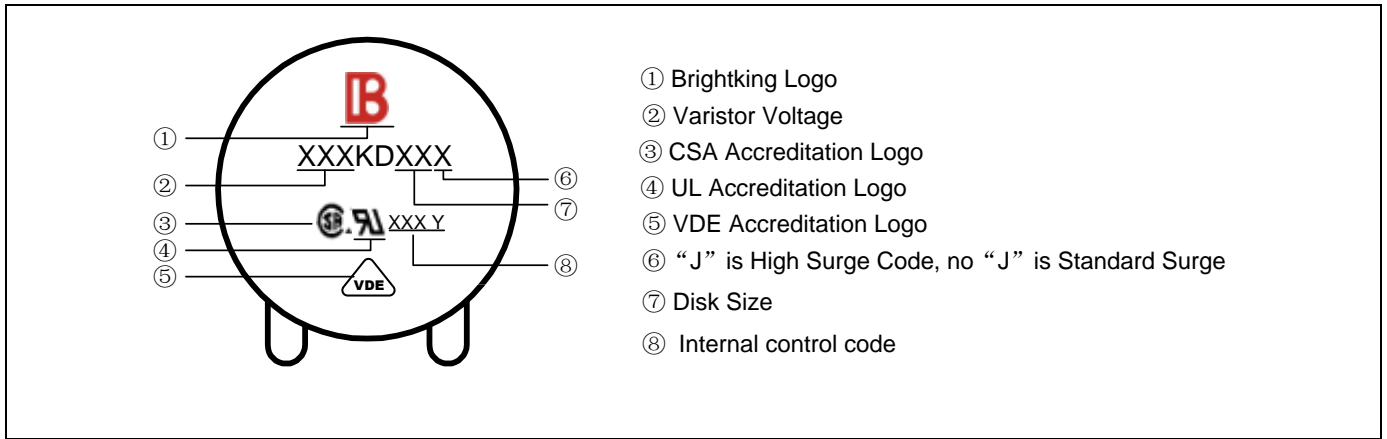

Taping Dimensions

Symbol	Dimensions (mm)
P	25.4±1.0
P0	12.7±1.0
P1	8.95±0.7
P2	12.7±1.3
F	7.5±0.8
h	0±4
W	18.0±1.0
W0	12.0±1.0
W1	9.0±0.5
W2	3.0max
H	20.0±2.0
D0	4.0±0.2
t	0.6±0.3
B	40max

Quantity

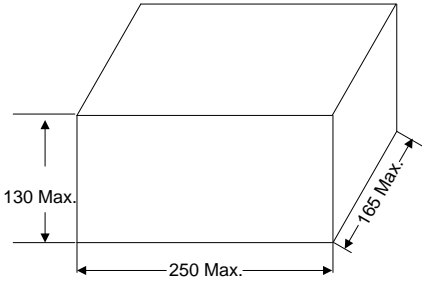
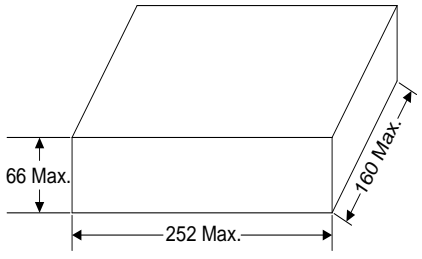
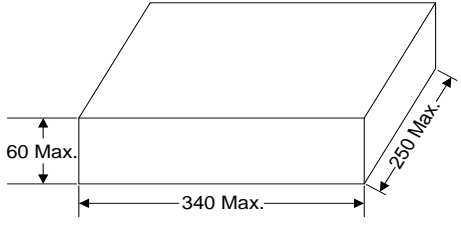
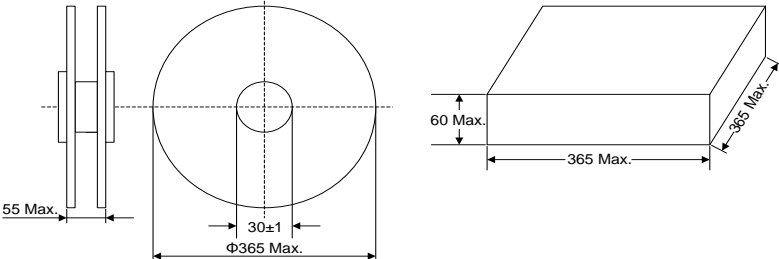
Packaging Dimensions (Unit: mm)	Quantity
<p>In bulk for Terminals Untrimmed Products</p> 	400pcs/bag 4bags/box (180K~331K)
	300pcs/bag 4bags/box (361K~621K)
	250pcs/bag 4bags/box (681K~112K)
	150pcs/bag 4bags/box (122K~182K)
<p>In bulk for Terminals Trimmed Products</p> 	400pcs/bag 4bags/box (180K~331K)
	300pcs/bag 4bags/box (361K~621K)
	250pcs/bag 4bags/box (681K~112K)
	150pcs/bag 4bags/box (122K~182K)
<p>Tape & Box</p> 	750pcs/box (180K~331K)
	500pcs/box (361K~621K)
	400pcs/box (681K~751K)
<p>Tape & Reel</p> 	1000pcs/reel (180K~331K)
	750pcs/reel (361K~621K)
	500pcs/reel (681K~751K)

X-ON Electronics

Largest Supplier of Electrical and Electronic Components

Click to view similar products for [Varistors](#) category:

Click to view products by [Brightking](#) manufacturer:

Other Similar products are found below :

[820443211E](#) [MLV0402E30703T](#) [MLV0603E30403T](#) [B72205S271K111](#) [B72207S350K311](#) [B72207S381K101](#) [B72260B102K1](#)
[B72260B251K1](#) [B72280B0381K001](#) [B72280B0461K001](#) [B72280B271K1](#) [B72650M0151K093](#) [B72660M0271K093](#) [S10K11G5S5](#) [ERZ-](#)
[C07DK221U](#) [TND10V-471KB00AAA0](#) [B72205S301K211](#) [B72207S141K111](#) [B72210S271K111](#) [B72214S350K551](#) [B72220P3351K101](#)
[B72280B0231K001](#) [B72280B112K1](#) [B72280B381K1](#) [B72590D360A60](#) [B72650M0400K072](#) [B72650M0500K072](#) [B72660M0200K072](#)
[B72660M1300K072](#) [B72670M1140K72](#) [MLV0603E30703T](#) [MLV0603E32503T](#) [TVZ18EC271KBS](#) [TVZ20EB911KBS](#) [TVZ25D201KBS](#)
[TVZ25D241KBS](#) [419-2080-101](#) [ERZ-V20R201](#) [MLV0805E31103T](#) [MLV0805E30703T](#) [ERZ-V20R221](#) [B72205S350K211](#)
[B72210P2511K101](#) [B72214S271K501](#) [B72220P3551K101](#) [B72240B681K1](#) [B72650M350K72](#) [TVZ20ECN511KBS](#) [TVZ20EC911KBS](#)
[TVZ20EBN911KBS](#)