

Metal Oxide Varistors (MOV) Data Sheet

Features

- Wide operating voltage (V_{1mA}) range from 18V to 1100V
- Fast responding to transient over-voltage
- Large absorbing transient energy capability
- Low clamping ratio and no follow-on current
- Meets MSL level 1, per J-STD-020
- Operating Temperature : $-40^{\circ}\text{C} \sim +105^{\circ}\text{C}$
- Storage Temperature : $-40^{\circ}\text{C} \sim +125^{\circ}\text{C}$
- Safety certification: UL: E327997
CSA: 246579
VDE: 40027827



Applications

- Transistor, diode, IC, thyristor or triac semiconductor protection
- Surge protection in consumer electronics
- Surge protection in industrial electronics
- Surge protection in electronic home appliances, gas and petroleum appliances
- Relay and electromagnetic valve surge absorption

Part Number Code

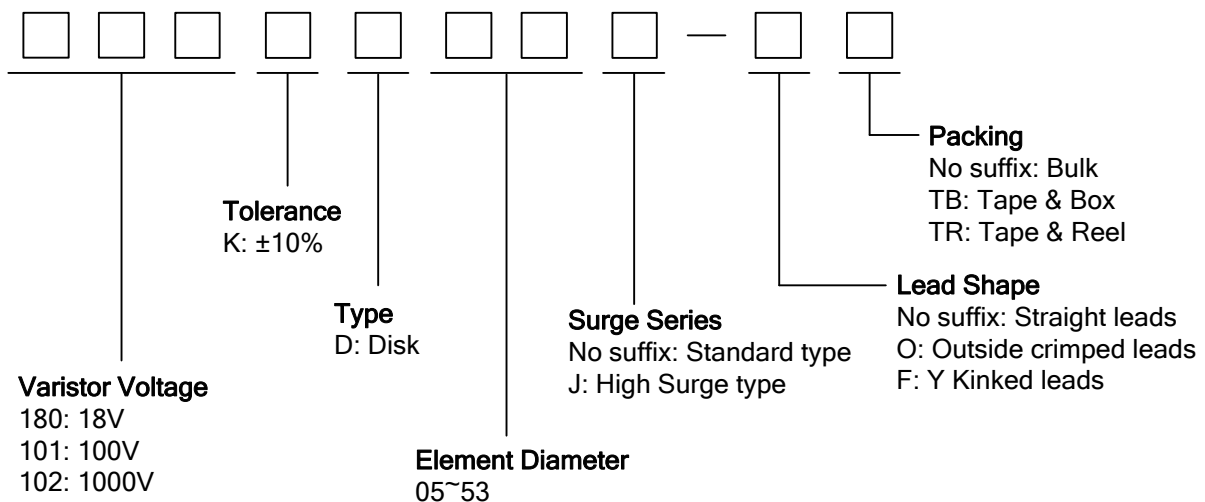

Dimensions

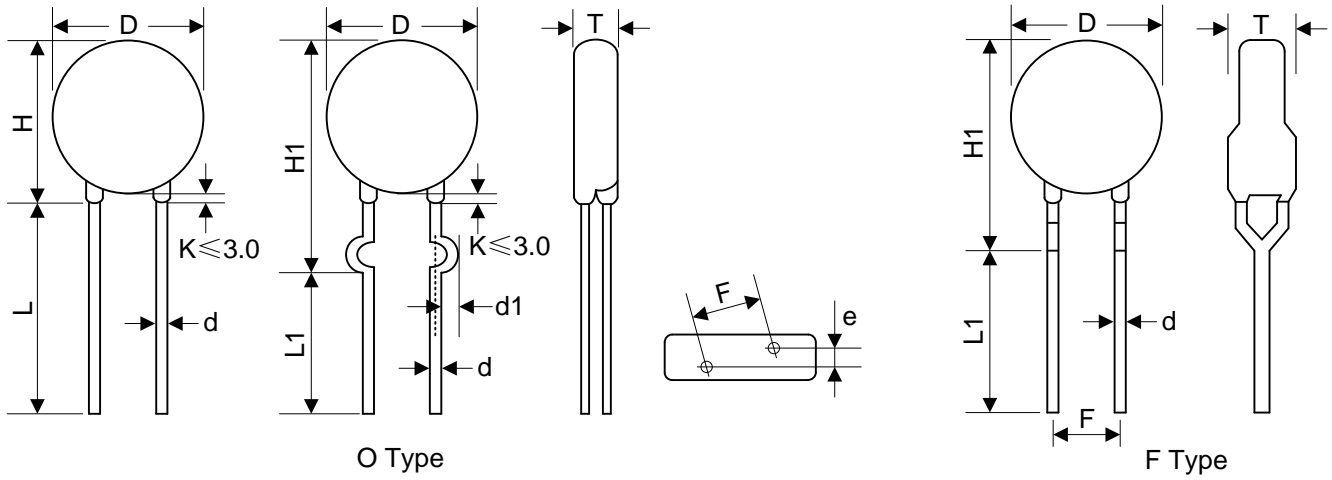

O Type

F Type

Table 1	
Unit: mm	
Symbol	Dimension
H	10.5~16.0
H1	13.0~17.5
L(min.)	20.0
L1(min.)	15.0
D	10.0~12.5
F(±0.8)	7.5
T	Table 2
e(±0.8)	Table 2
d(±0.05)	0.8
d1(±0.4)	1.4

Table 2					
Unit: mm					
Model	T	e	Model	T	e
180K	2.0~4.6	1.5	301K	2.7~5.5	2.5
220K	2.1~4.7	1.6	331K	2.7~5.8	2.5
270K	2.1~4.8	1.8	361K	2.9~6.0	2.7
330K	2.2~5.0	1.7	391K	3.0~6.2	2.8
390K	2.1~5.3	1.8	431K	3.2~6.5	3.0
470K	2.2~5.4	1.9	471K	3.3~6.7	3.2
560K	2.3~5.5	2.1	511K	3.4~6.8	3.4
680K	2.4~5.6	2.4	561K	3.6~7.0	3.6
820K	2.1~4.7	1.8	621K	3.8~7.3	3.9
101K	2.4~4.9	2.0	681K	4.0~7.6	4.2
121K	2.4~5.1	2.2	751K	4.3~8.0	4.3
151K	2.2~5.4	1.8	781K	4.4~8.1	4.4
181K	2.3~4.8	1.9	821K	4.6~8.3	4.6
201K	2.4~5.0	2.0	911K	4.8~8.8	5.0
221K	2.5~5.1	2.1	102K	5.4~9.3	5.0
241K	2.6~5.2	2.2	112K	5.8~9.9	5.4
271K	2.6~5.4	2.4			

Electrical Characteristics

Part Number		Maximum Allowable Voltage		Varistor Voltage	Maximum Clamping Voltage		Withstanding Surge Current		Maximum Energy (10/1000μs)		Rated Power	Typical Capacitance (Reference)
Standard	High Surge	V _{AC} (V)	V _{DC} (V)	V _{1mA} (V)	I _P (A)	V _C (V)	I (A) Standard	I (A) High Surge	(J) Standard	(J) High Surge	(W)	@1KHz (pf)
180KD10	180KD10J	11	14	18(15~21.6)	5	36	500	1000	2.1	3.0	0.05	5600
220KD10	220KD10J	14	18	22(19.5~26)	5	43	500	1000	2.5	5.0	0.05	4500
270KD10	270KD10J	17	22	27(25~31)	5	53	500	1000	3.0	6.0	0.05	3700
330KD10	330KD10J	20	26	33(29.5~36.5)	5	65	500	1000	4.0	7.0	0.05	3000
390KD10	390KD10J	25	31	39(35~43)	5	77	500	1000	4.6	9.0	0.05	2400
470KD10	470KD10J	30	38	47(42~52)	5	93	500	1000	5.5	11.0	0.05	2100
560KD10	560KD10J	35	45	56(50~62)	5	110	500	1000	7.0	13.0	0.05	1800
680KD10	680KD10J	40	56	68(61~75)	5	135	500	1000	8.2	15.0	0.05	1500
820KD10	820KD10J	50	65	82(74~90)	25	135	2500	3500	12.0	17.0	0.4	1200
101KD10	101KD10J	60	85	100(90~110)	25	165	2500	3500	15.0	18.0	0.4	1000
121KD10	121KD10J	75	100	120(108~132)	25	200	2500	3500	18.0	21.0	0.4	830
151KD10	151KD10J	95	125	150(135~165)	25	250	2500	3500	22.0	25.0	0.4	670
181KD10	181KD10J	115	150	180(162~198)	25	300	2500	3500	27.0	30.0	0.4	560
201KD10	201KD10J	130	170	200(180~220)	25	340	2500	3500	30.0	35.0	0.4	500
221KD10	221KD10J	140	180	220(198~242)	25	360	2500	3500	32.0	39.0	0.4	450
241KD10	241KD10J	150	200	240(216~264)	25	395	2500	3500	35.0	42.0	0.4	420
271KD10	271KD10J	175	225	270(243~297)	25	455	2500	3500	37.0	49.0	0.4	370
301KD10	301KD10J	190	250	300(270~330)	25	500	2500	3500	40.0	54.0	0.4	330
331KD10	331KD10J	210	275	330(297~363)	25	550	2500	3500	43.0	58.0	0.4	300
361KD10	361KD10J	230	300	360(324~396)	25	595	2500	3500	47.0	65.0	0.4	280
391KD10	391KD10J	250	320	390(351~429)	25	650	2500	3500	60.0	70.0	0.4	260
431KD10	431KD10J	275	350	430(387~473)	25	710	2500	3500	65.0	80.0	0.4	230
471KD10	471KD10J	300	385	470(423~517)	25	775	2500	3500	67.0	85.0	0.4	210
511KD10	511KD10J	320	415	510(459~561)	25	845	2500	3500	69.0	90.0	0.4	200
561KD10	561KD10J	350	460	560(504~616)	25	925	2500	3500	70.0	92.0	0.4	180
621KD10	621KD10J	385	505	620(558~682)	25	1025	2500	3500	72.0	95.0	0.4	160
681KD10	681KD10J	420	560	680(612~748)	25	1120	2500	3500	75.0	98.0	0.4	150
751KD10	751KD10J	460	615	750(675~825)	25	1240	2500	3500	77.0	100.0	0.4	130
781KD10	781KD10J	485	640	780(702~858)	25	1290	2500	3500	80.0	105.0	0.4	125
821KD10	821KD10J	510	670	820(738~902)	25	1355	2500	3500	85.0	110.0	0.4	120
911KD10	911KD10J	550	745	910(819~1001)	25	1500	2500	3500	93.0	130.0	0.4	110
102KD10	102KD10J	625	825	1000(900~1100)	25	1650	2500	3500	102.0	140.0	0.4	100
112KD10	112KD10J	680	895	1100(990~1210)	25	1815	2500	3500	115.0	155.0	0.4	90

Notes: 1. The tolerance of varistor voltage between 18V and 27V is more than 10%.

2. Leakage Current (@83% of V_{1mA}) : IR≤50μA (180K~680K) IR≤25μA (820K~112K)

Electrical Ratings

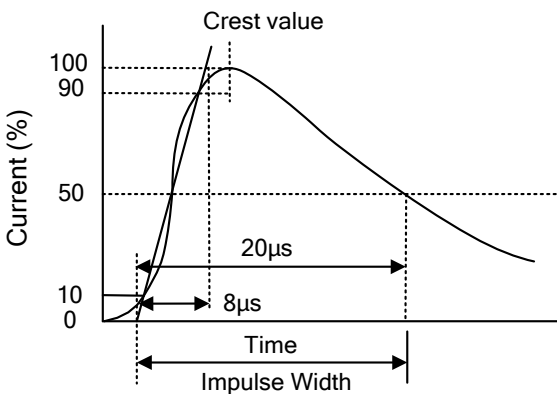
Items	Test Condition/Description	Requirement					
Varistor Voltage	The voltage between the two terminals with the specified measuring current 1mA.DC applied is called Vb.						
Maximum Allowable Voltage	The recommended maximum sine wave voltage (RMS) or the Maximum DC voltage can be applied continuously.						
Maximum Clamping Voltage	<p>The maximum voltage between the two terminals with the specification standard impulse current.</p> <p>Applied waveform: 8/20μs</p> 	To meet the Specified value					
Rated Wattage	The maximum average power that can be applied within the specified ambient temperature.						
Energy	The maximum energy within the varistor voltage change of ±10% when one impulse of 10/1000μs or 2ms is applied.						
Withstanding Surge Current	The maximum current within the varistor voltage change of ±10% with the standard impulse current (8/20μs) applied one time.						
Varistor Voltage Temp. Coefficient	$\left \frac{V_{1mA@105^{\circ}C} - V_{1mA@25^{\circ}C}}{V_{1mA@25^{\circ}C}} \times \frac{1}{80} \times 100\%(\%/^{\circ}C) \right $	≤0.05%/°C					
	$\left \frac{V_{1mA@-40^{\circ}C} - V_{1mA@25^{\circ}C}}{V_{1mA@25^{\circ}C}} \times \frac{1}{65} \times 100\%(\%/^{\circ}C) \right $						
Surge Life	<p>The change of Vb shall be measured after the impulse listed below which is applied 10,000 times continuously with the interval of ten seconds at room temperature.</p> <table border="1" data-bbox="438 1892 1200 2018"> <tbody> <tr> <td rowspan="2">10Φ series</td> <td>180K to 680K</td> <td>50A (8/20μs)</td> </tr> <tr> <td>820K to 112K</td> <td>100A (8/20μs)</td> </tr> </tbody> </table>	10Φ series	180K to 680K	50A (8/20μs)	820K to 112K	100A (8/20μs)	$\frac{\Delta V_b}{V_b} \leq \pm 10\%$
10Φ series	180K to 680K		50A (8/20μs)				
	820K to 112K	100A (8/20μs)					

Soldering Recommendation

Lead-free Wave Soldering Recommendation

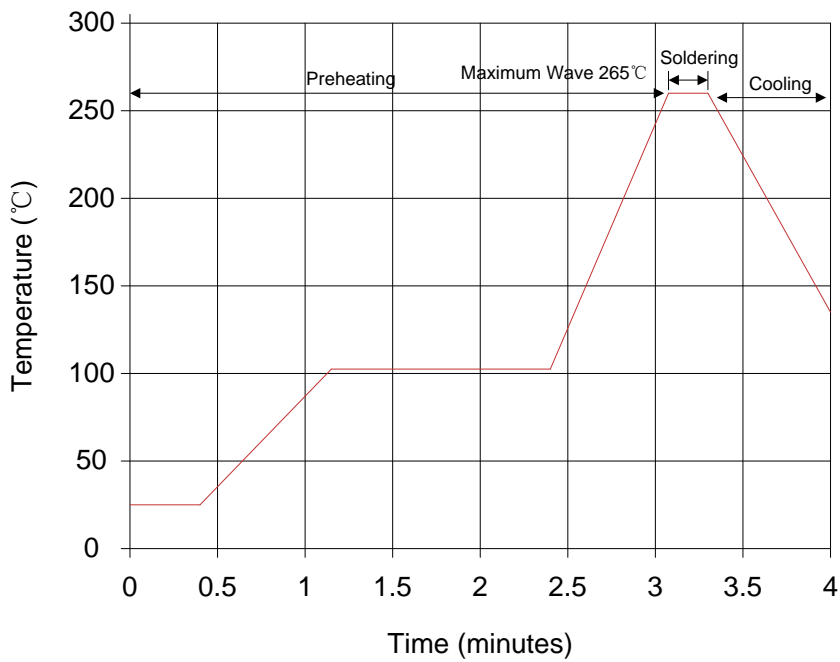

Item	Conditions
Peak Temperature	265°C
Dipping Time	10 seconds (max.)
Soldering	1 time

Recommendation Reworking Conditions with Soldering Iron

Item	Conditions
Temperature of Soldering Iron-tip	360°C (max.)
Soldering Time	3 seconds (max.)
Distance from Varistor	2mm (min.)

Mechanical Characteristics

Items	Test conditions / Methods	Specifications								
Tensile Strength of Terminals	Gradually applying the force specified and keeping the unit fixed for 10±1 sec. <table border="1" style="margin-left: auto; margin-right: auto;"> <thead> <tr> <th>Terminal diameter (mm)</th> <th>Force (kg)</th> </tr> </thead> <tbody> <tr> <td>0.5<d≤0.8</td> <td>1.0</td> </tr> <tr> <td>0.8<d≤1.25</td> <td>2.0</td> </tr> <tr> <td>1.25<d</td> <td>4.0</td> </tr> </tbody> </table>	Terminal diameter (mm)	Force (kg)	0.5<d≤0.8	1.0	0.8<d≤1.25	2.0	1.25<d	4.0	No visible damage ΔV _{1mA} /V _{1mA} ≤5%
Terminal diameter (mm)	Force (kg)									
0.5<d≤0.8	1.0									
0.8<d≤1.25	2.0									
1.25<d	4.0									
Bending Strength of Terminals	Hold specimen and apply the force specified below to each lead. Bend the specimen to 90°, then return to the original position. Repeat the procedure in the opposite direction. <table border="1" style="margin-left: auto; margin-right: auto;"> <thead> <tr> <th>Terminal diameter (mm)</th> <th>Force (kg)</th> </tr> </thead> <tbody> <tr> <td>0.5<d≤0.8</td> <td>0.5</td> </tr> <tr> <td>0.8<d≤1.25</td> <td>1.0</td> </tr> <tr> <td>1.25<d</td> <td>2.0</td> </tr> </tbody> </table>	Terminal diameter (mm)	Force (kg)	0.5<d≤0.8	0.5	0.8<d≤1.25	1.0	1.25<d	2.0	No visible damage ΔV _{1mA} /V _{1mA} ≤5%
Terminal diameter (mm)	Force (kg)									
0.5<d≤0.8	0.5									
0.8<d≤1.25	1.0									
1.25<d	2.0									
Vibration	Frequency range: 10~55 Hz Amplitude: 0.75mm or 98m/s ² Direction: 3 mutually perpendicular directions, 2hrs each.	No visible damage ΔV _{1mA} /V _{1mA} ≤5%								
Solder ability	Solder Temp: 245±5°C Dipping Time: 2±0.5 sec	At least 95% of terminal electrode is covered by new solder								
Resistance to Soldering Heat	Solder Temp: 260±5°C Dipping Time: 10±1 sec	No visible damage ΔV _{1mA} /V _{1mA} ≤10%								

Reliability

Items	Test conditions / Methods	Specifications															
High Temperature Storage	Ambient Temp: 125±2°C Duration: 1000hrs	ΔV _{1mA} /V _{1mA} ≤5%															
Low Temperature Storage	Ambient Temp: -40±2°C Duration: 1000hrs	ΔV _{1mA} /V _{1mA} ≤5%															
Humidity	Ambient Temp: 40±2°C, 90~95% R.H. Duration: 1000hrs	ΔV _{1mA} /V _{1mA} ≤5%															
Temperature Cycle	The conditions shown below shall be repeated 5 cycles <table border="1" style="margin-left: auto; margin-right: auto;"> <thead> <tr> <th>Step</th> <th>Temperature (°C)</th> <th>Period (minutes)</th> </tr> </thead> <tbody> <tr> <td>1</td> <td>-40±3</td> <td>30±3</td> </tr> <tr> <td>2</td> <td>Room temperature</td> <td>15±3</td> </tr> <tr> <td>3</td> <td>125±3</td> <td>30±3</td> </tr> <tr> <td>4</td> <td>Room temperature</td> <td>15±3</td> </tr> </tbody> </table>	Step	Temperature (°C)	Period (minutes)	1	-40±3	30±3	2	Room temperature	15±3	3	125±3	30±3	4	Room temperature	15±3	No visible damage ΔV _{1mA} /V _{1mA} ≤5%
Step	Temperature (°C)	Period (minutes)															
1	-40±3	30±3															
2	Room temperature	15±3															
3	125±3	30±3															
4	Room temperature	15±3															
High Temperature Load	Ambient Temp: 105±2°C Duration: 1000hrs Load: Max. Allowable Voltage In AC eara.	ΔV _{1mA} /V _{1mA} ≤10%															
Damp Heat Load	Ambient Temp: 40±2°C, 90~95% R.H. Duration: 1000hrs Load: Max. Allowable Voltage	No visible damage ΔV _{1mA} /V _{1mA} ≤10%															
Voltage Proof	Metal balls method, 2500Vac 1 min.	No visible damage															

Maximum Surge Current Derating Curve

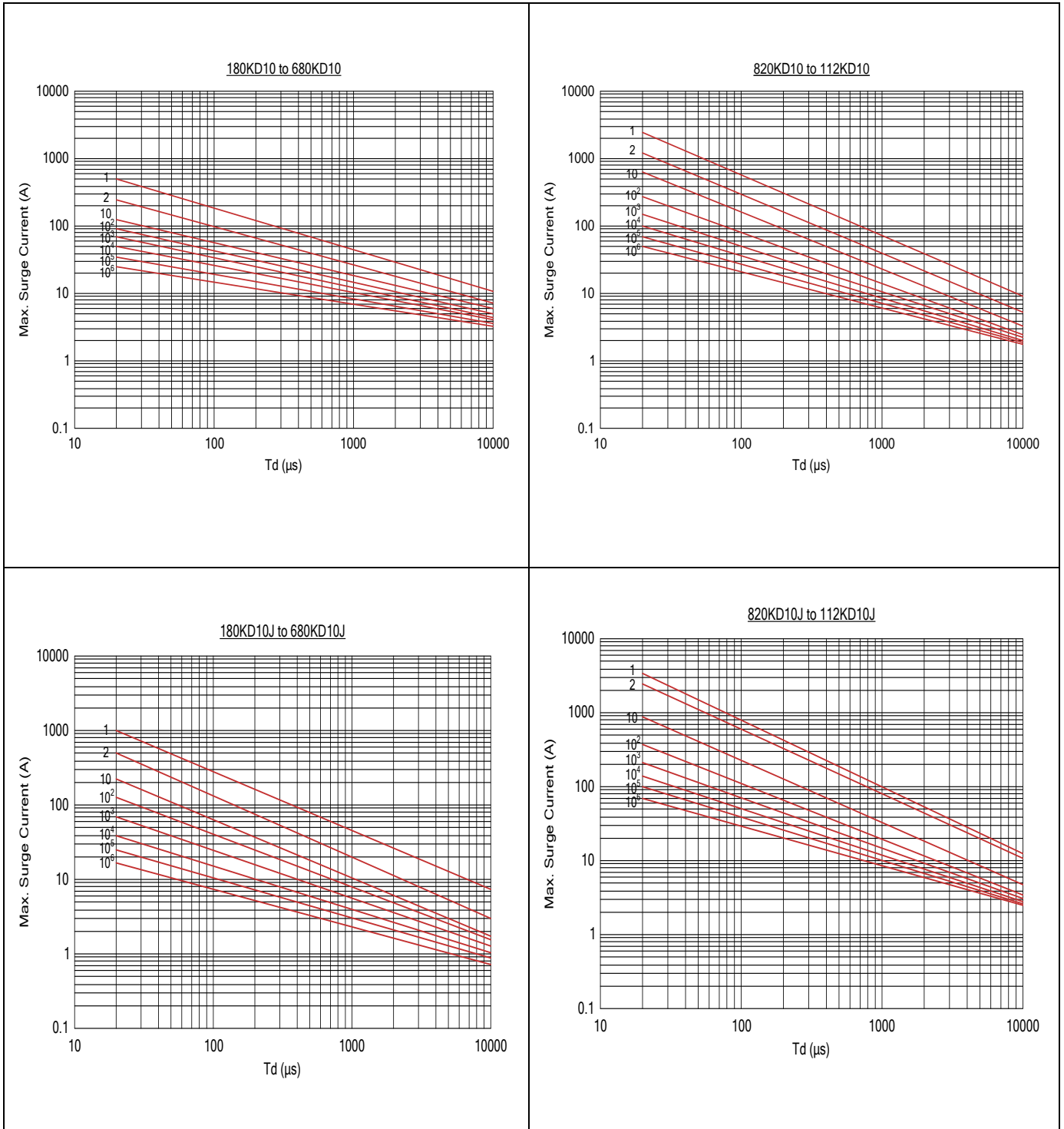

Maximum Leakage Current and Maximum Clamping Voltage Curve

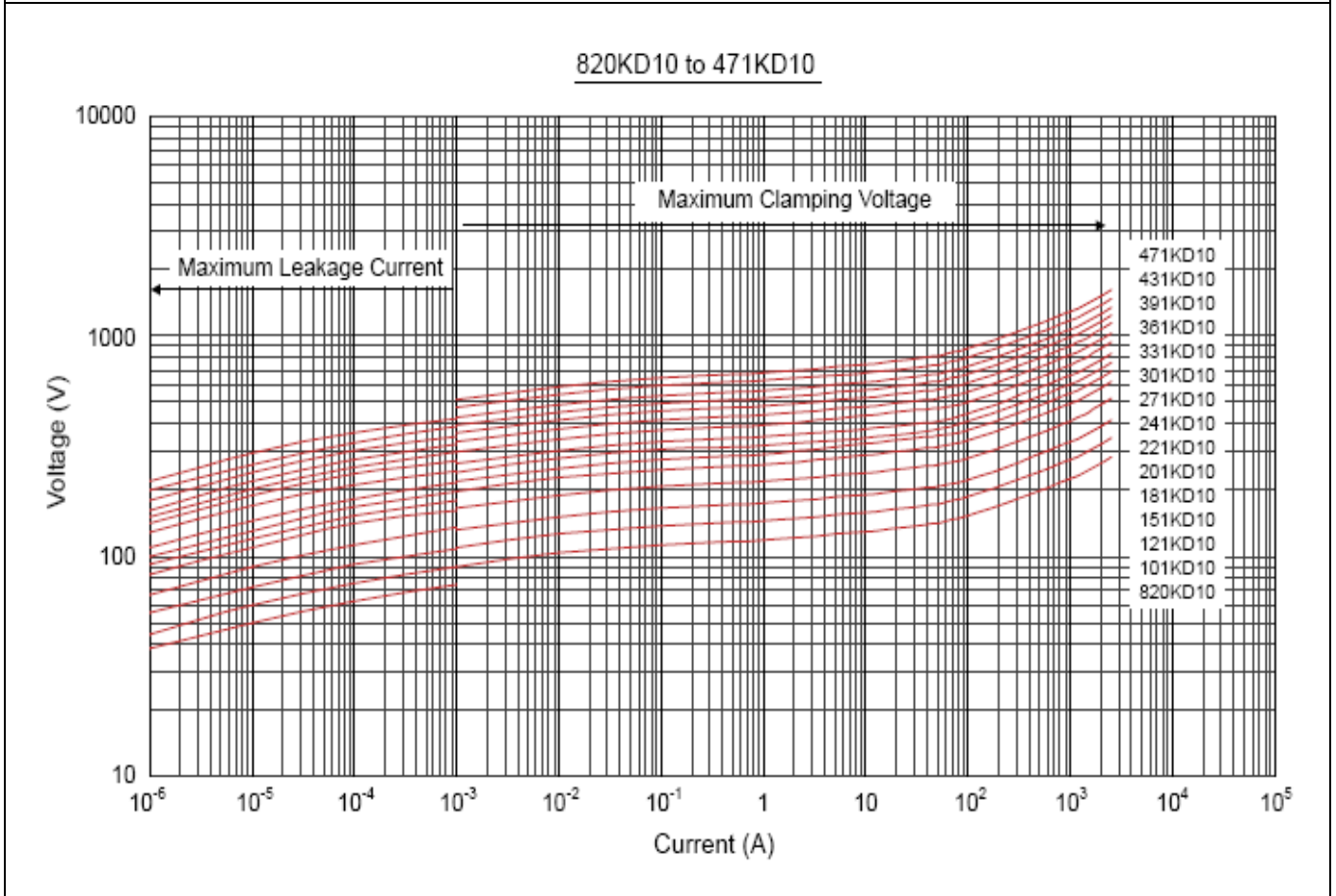
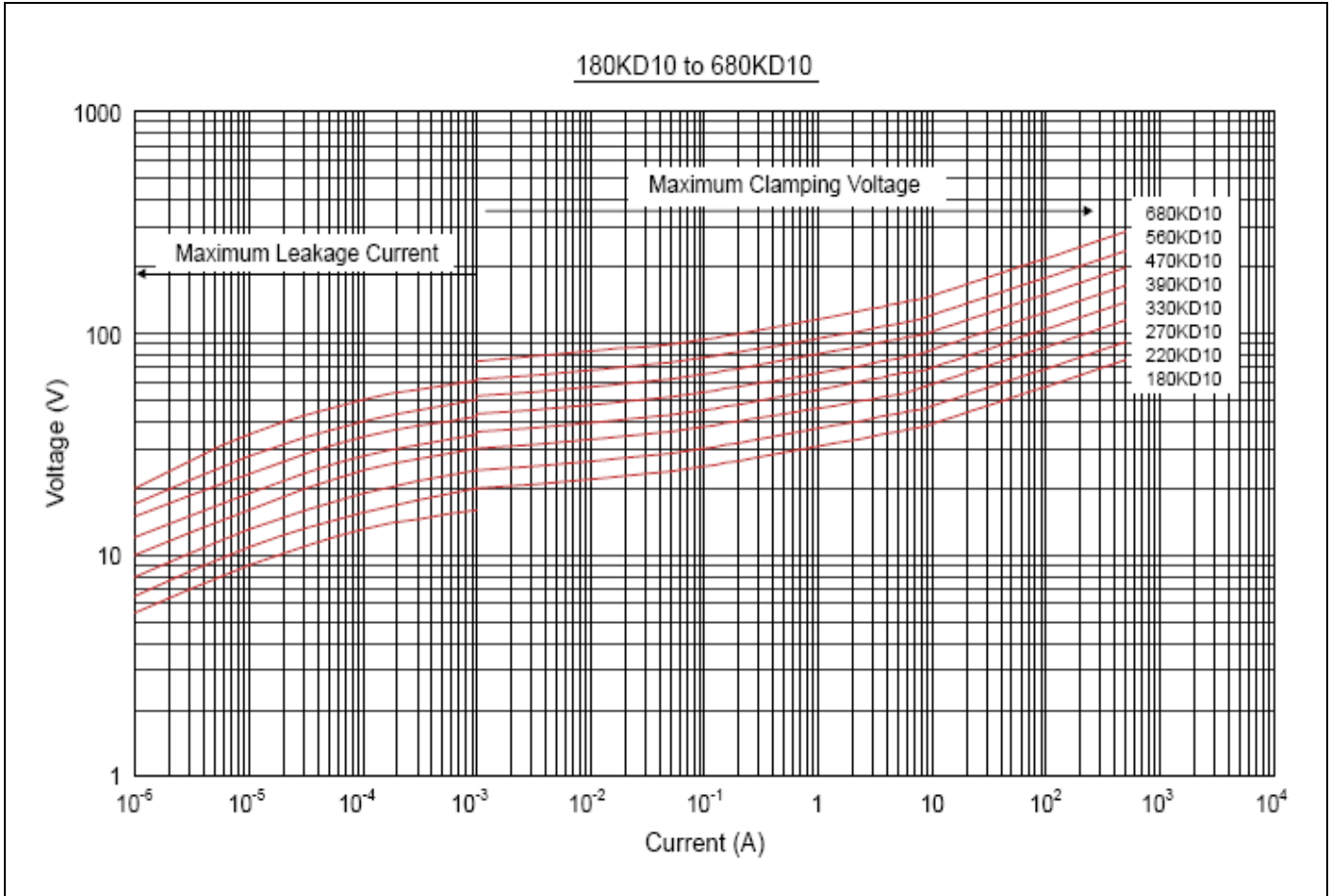

Maximum Leakage Current and Maximum Clamping Voltage Curve

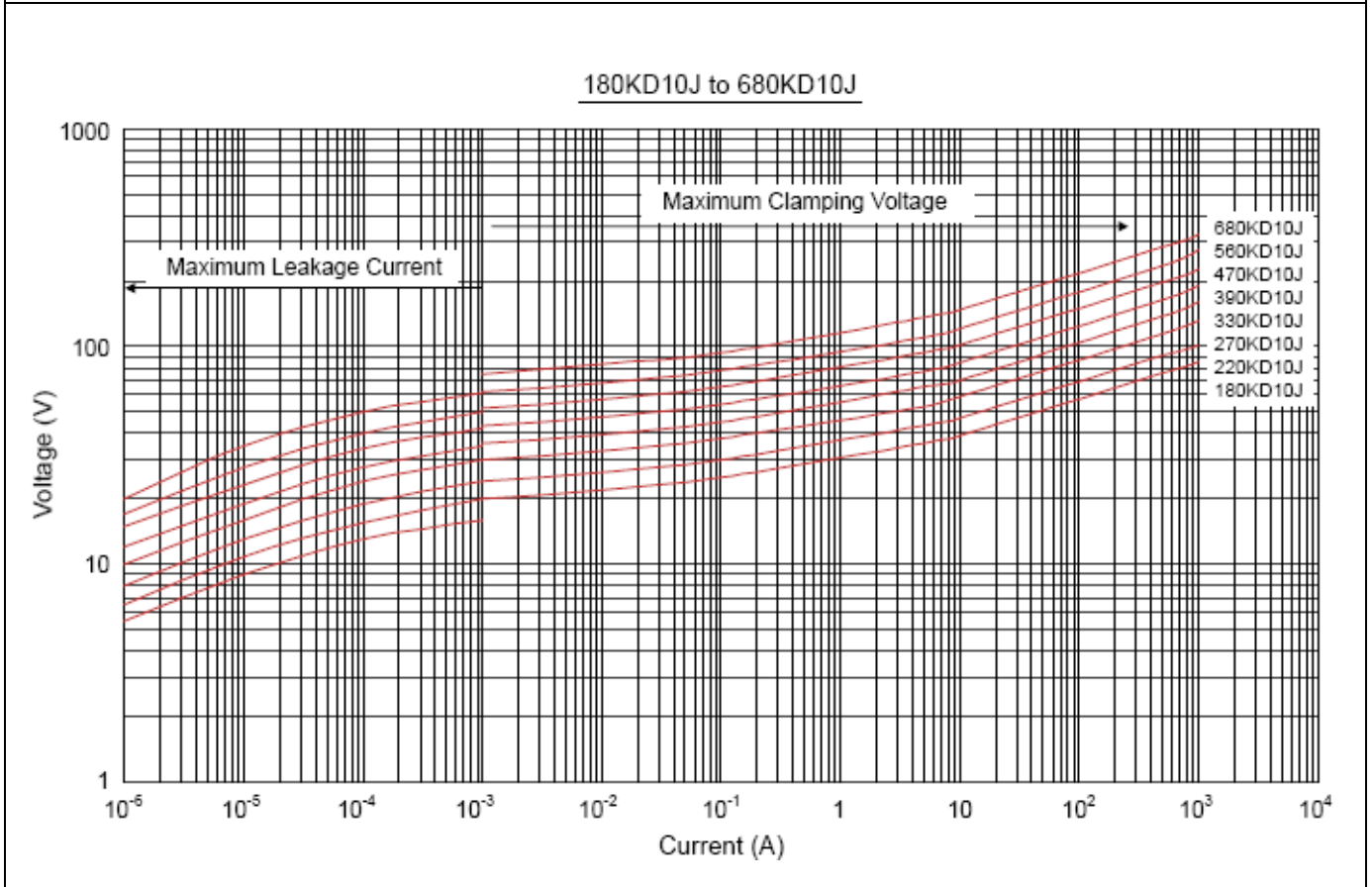
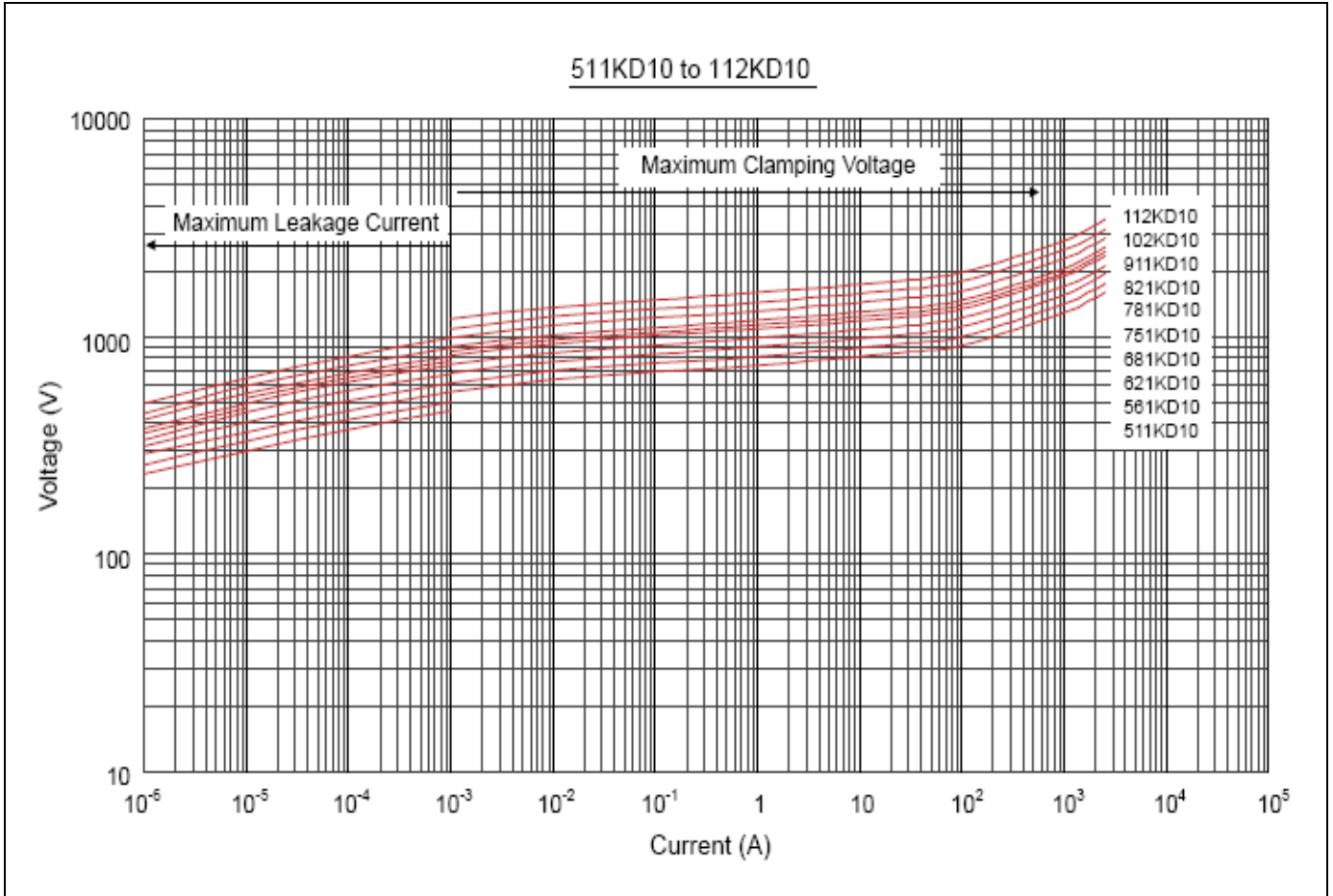

Maximum Leakage Current and Maximum Clamping Voltage Curve

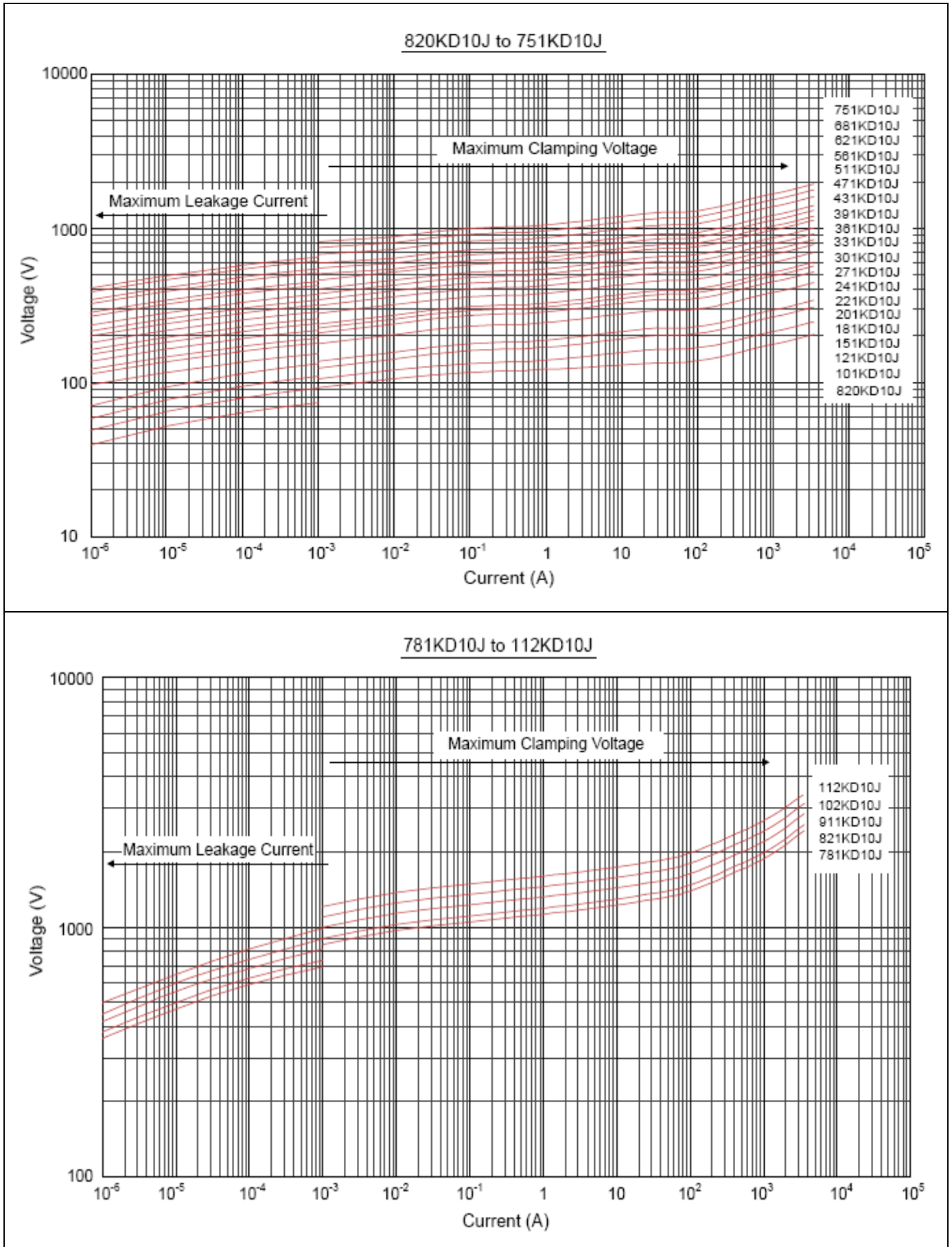

Marking Code

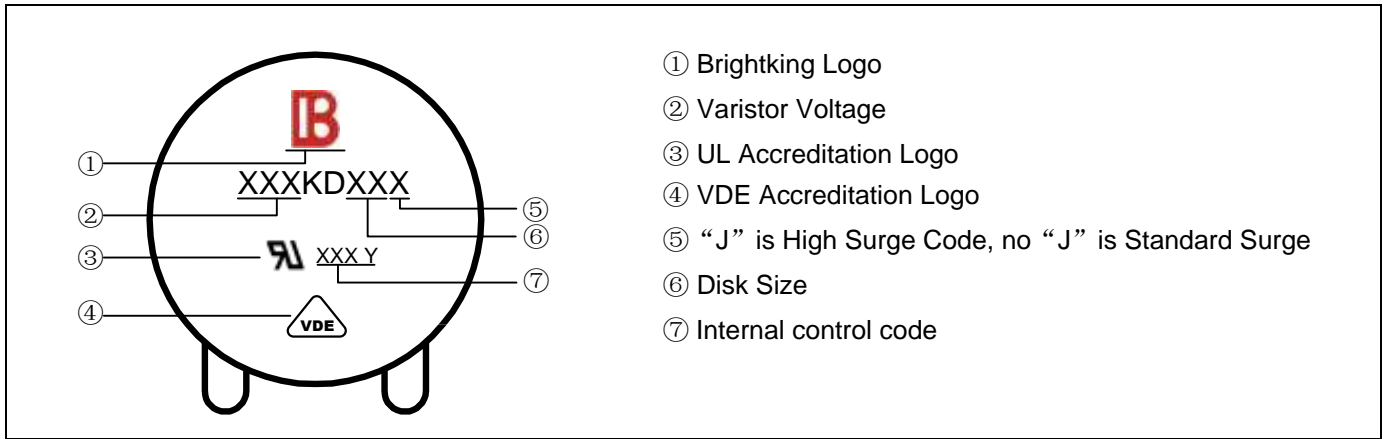

Taping Dimensions

Symbol	Dimension (mm)
P	25.4±1.0
P0	12.7±1.0
P1	8.95±0.7
P2	12.7±1.3
F	7.5±0.8
h	0±2
W	18.0±1.0
W0	12.0±1.0
W1	9.0±0.5
W2	3.0max
H	20.0±2.0
I	1.0max
D0	4.0±0.2
t	0.6±0.3
B	36max

Quantity

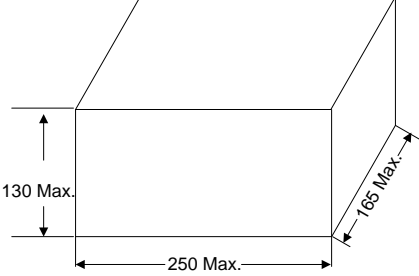
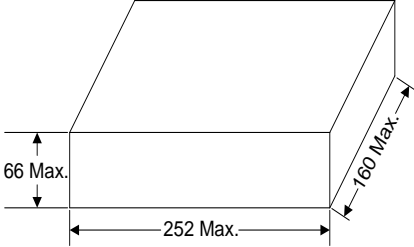
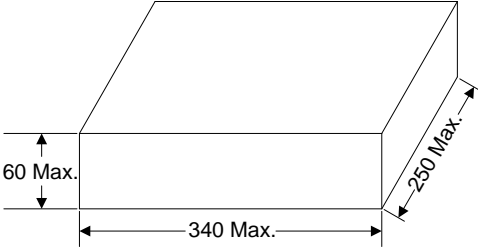
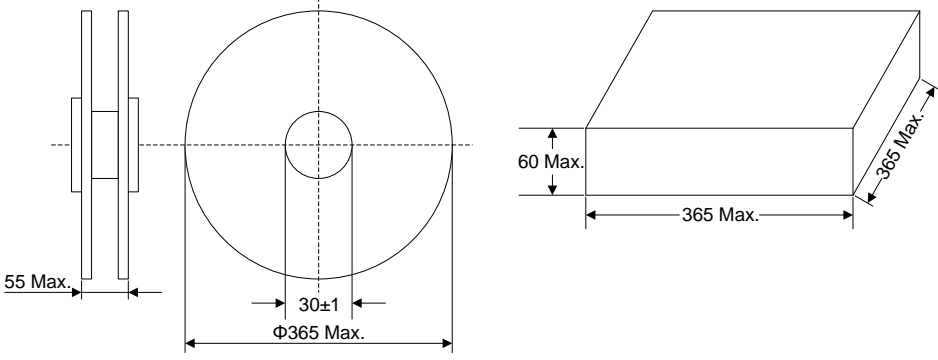
Packaging Dimensions (Unit: mm)	Quantity
<p>In bulk for Terminals Untrimmed Products</p> 	<p>500pcs/bag 4bags/box (180K~621K)</p>
<p>In bulk for Terminals Trimmed Products</p> 	<p>500pcs/bag 4bags/box (180K~621K)</p> <p>400pcs/bag 4bags/box (681K~112K)</p>
<p>Tape & Box</p> 	<p>750pcs/box (180K~391K)</p> <p>500pcs/box (431K~621K)</p> <p>300pcs/box (681K~751K)</p>
<p>Tape & Reel</p> 	<p>1000pcs/reel (180K~391K)</p> <p>750pcs/reel (431K~621K)</p> <p>500pcs/reel (681K~751K)</p>

X-ON Electronics

Largest Supplier of Electrical and Electronic Components

Click to view similar products for [Varistors](#) category:

Click to view products by [Brightking](#) manufacturer:

Other Similar products are found below :

[820443211E](#) [MLV0402E30703T](#) [MLV0603E30403T](#) [B72205S271K111](#) [B72207S350K311](#) [B72207S381K101](#) [B72260B102K1](#)
[B72260B251K1](#) [B72280B0381K001](#) [B72280B0461K001](#) [B72280B271K1](#) [B72650M0151K093](#) [B72660M0271K093](#) [S10K11G5S5](#) [ERZ-](#)
[C07DK221U](#) [TND10V-471KB00AAA0](#) [B72205S301K211](#) [B72207S141K111](#) [B72210S271K111](#) [B72214S350K551](#) [B72220P3351K101](#)
[B72280B0231K001](#) [B72280B112K1](#) [B72280B381K1](#) [B72590D360A60](#) [B72650M0400K072](#) [B72650M0500K072](#) [B72660M0200K072](#)
[B72660M1300K072](#) [B72670M1140K72](#) [MLV0603E30703T](#) [MLV0603E32503T](#) [TVZ18EC271KBS](#) [TVZ20EB911KBS](#) [TVZ25D201KBS](#)
[TVZ25D241KBS](#) [419-2080-101](#) [ERZ-V20R201](#) [MLV0805E31103T](#) [MLV0805E30703T](#) [ERZ-V20R221](#) [B72205S350K211](#)
[B72210P2511K101](#) [B72214S271K501](#) [B72220P3551K101](#) [B72240B681K1](#) [B72650M350K72](#) [TVZ20ECN511KBS](#) [TVZ20EC911KBS](#)
[TVZ20EBN911KBS](#)