

Positive Temperature Coefficient (PTC) Data Sheet

Description

The 30V series provides radial resettable overcurrent protection with holding current from 0.9A to 9.0A. This series is suitable for applications with higher working voltage up to 30V.

Features

- Radial leaded devices.
- Over-current protection
- High voltage surge capabilities
- Flame retardant epoxy polymer insulating material meets UL94 V-0 requirement.
- Available in lead-free version.
- Meets MSL level 1, per J-STD-020
- Operating Temperature: -40°C~+85°C



Applications

- Powered USB for POS and IPC
- USB hubs, ports and peripherals
- General electronics
- Computers & peripherals
- Automotive applications
- Motor protection

Part Number Code and Making

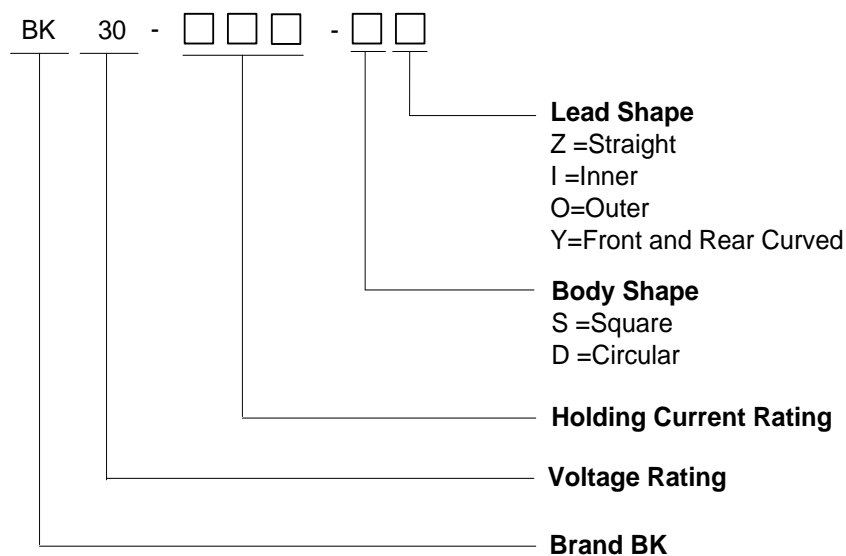

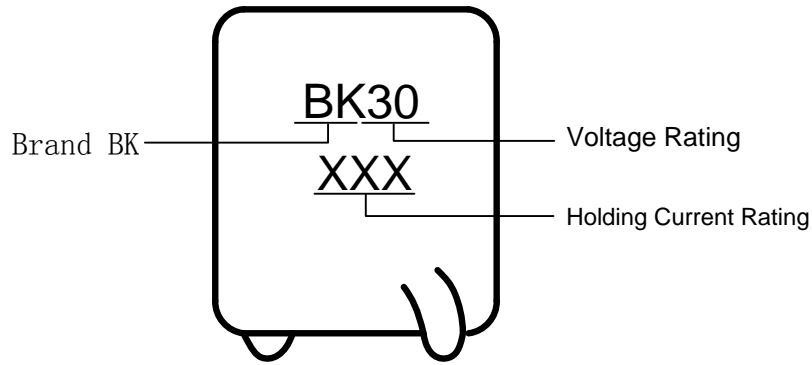

Dimensions (Unit: mm)

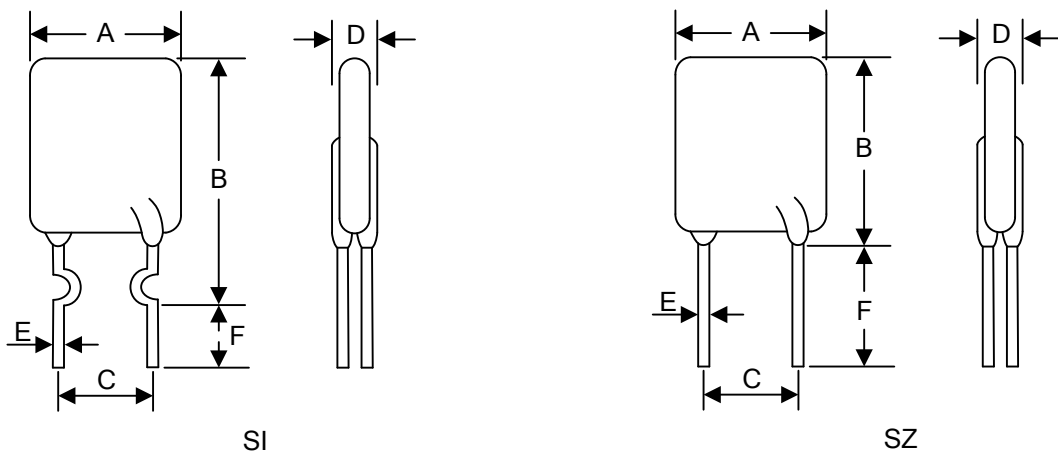

Part Number	A	B	C	D	E	F	Style.
	Max.	Max.	±0.6	Max.	Typ.	Min.	
BK30-090	7.4	14.5/14.2	5.1	3.1	0.5	4.6 / 7.6	SI / SZ
BK30-110	7.4	17.8/14.2	5.1	3.1	0.5	4.6 / 7.6	SI / SZ
BK30-135	9.2	16.8	5.1	3.1	0.5	4.6	SI
BK30-160	9.5	16.5	5.1	3.1	0.5	4.6	SI
BK30-185	9.8	18.6	5.1	3.1	0.5	4.6	SI
BK30-200	11.0	18.6	5.1	3.1	0.5	4.6	SI
BK30-250	13.2	20.5	5.1	3.1	0.5	4.6	SI
BK30-300	13.2	20.5	5.1	3.1	0.8	7.6	SZ
BK30-400	14.0	23.6	5.1	3.1	0.8	7.6	SZ
BK30-500	14.0	23.6	10.5	3.1	0.8	7.6	SZ
BK30-600	17.5	27.5	10.5	3.1	0.8	7.6	SZ
BK30-700	17.5	27.5	10.5	3.1	0.8	7.6	SZ
BK30-800	23.5	31.0	10.5	3.1	0.8	7.6	SZ
BK30-900	24.3	31.5	10.5	3.1	0.8	7.6	SZ

Electrical Characteristics

Part Number	I _H	I _T	V _{max}	I _{max}	P _{d typ.}	Max. Time-to-trip		R _{min}	R _{max}
	(A)	(A)	(V _{DC})	(A)	(W)	(A)	(S)	(Ω)	(Ω)
BK30-090	0.90	1.80	30	40	0.6	4.50	5.90	0.090	0.220
BK30-110	1.10	2.20	30	40	0.7	5.50	6.60	0.070	0.200
BK30-135	1.35	2.70	30	40	0.8	6.75	7.30	0.055	0.160
BK30-160	1.60	3.20	30	40	0.9	8.00	8.00	0.045	0.140
BK30-185	1.85	3.70	30	40	1.0	9.25	8.70	0.035	0.120
BK30-200	2.00	4.00	30	40	1.2	10.00	9.80	0.040	0.100
BK30-250	2.50	5.00	30	40	1.2	12.50	10.30	0.027	0.080
BK30-300	3.00	6.00	30	40	2.0	15.00	10.80	0.022	0.070
BK30-400	4.00	8.00	30	40	2.5	20.00	12.70	0.010	0.060
BK30-500	5.00	10.00	30	40	3.0	24.00	14.50	0.010	0.050
BK30-600	6.00	12.00	30	40	3.5	30.00	16.00	0.005	0.040
BK30-700	7.00	14.00	30	40	3.8	35.00	17.50	0.005	0.030
BK30-800	8.00	16.00	30	40	4.0	40.00	18.80	0.005	0.025
BK30-900	9.00	18.00	30	40	4.2	45.00	20.00	0.005	0.020

- I_H = Hold current: maximum current device will pass without tripping in 25°C still air.
- I_T = Trip current: minimum current at which the device will trip in 25°C still air.
- V_{MAX} = Maximum voltage device can withstand without damage at rated current.
- I_{MAX} = Maximum fault current device can withstand without damage at rated voltage.
- R_{MAX} = Maximum resistance of device in initial (un-soldered) state.
- R_{MIN} = Minimum resistance of device in initial (un-soldered) state.
- P_{d typ.} = Typical power dissipation from device when in the tripped state at 25°C still air.

Polymeric PTC Selecting Guide

- Determine the following operating parameters for the circuits:
 - Normal operating current (I_{hold})
 - Maximum interrupt current (I_{max})
 - Maximum circuit voltage (V_{max})
 - Normal operating temperature surrounding device (min °C/max °C)
- Select the device from factor and dimension suitable for the application
- Compare the maximum rating for V_{max} and I_{max} of the PPTC device with the circuit in application and make sure the circuit's requirement does not exceed the device rating.
- Check that PPTC device's trip time (time-to-trip) will protect the circuit.
- Verify that the circuit operating temperature is within the PPTC device's normal operating temperature range.
- Verify that performance and suitability of the chosen PPTC device in the application.

WARNING

- **Mechanical Stress**
 - PPTC devices will undergo a thermal expansion during fault condition. If PPTC devices are installed or placed in an application where the space between PPTC devices and the surrounding materials (e.g., covering materials, packaging materials, encapsulate materials and the like) is insufficient, it will cause an inhibiting effect upon the thermal expansion. Pressing, twisting, bending and other kinds of mechanical stress will also adversely affect the performance of the PPTC devices, and shall not be used or applied.
- **Chemical Pollutants**
 - Silicone-based oils, oils, solvents, gels, electrolytes, fuels, acids, and the like will adversely affect the properties of PPTC devices, and shall not be used or applied.
- **Electronic and Thermal Effect**
 - PPTC devices are secondary protection devices and are used solely for sporadic, accidental over-current or over-temperature error condition, and shall NOT be used if or when constant or repeated fault conditions (such fault conditions may be caused by, among others, incorrect pin-connection of a connector) or over-extensive trip events may occur.
 - PPTC devices are different from fuses and, when a fault condition occurs, will go into high-resistance state and do not open circuit, in which case the voltage at such PPTC devices may reach a hazardous level.
 - Operation over the maximum rating or other forms of improper use may cause failure, arcing, flame and/or other damage to the PPTC devices.
 - Conductive material contamination, such as metal particle, may induce shortage, flame or arcing.
 - Due to the inductance, the operation circuits may generate a circuit voltage (Ldi/dt) above the rated voltage of PPTC devices, which shall not be used under such circumstances.
- **General**
 - Customers shall evaluate and test the properties of PPTC devices independently to verify and ensure that their individual applications will be met.
 - The performance of PPTC devices will be adversely affected if they are improperly used under electronic, thermal and/or mechanical procedures and/or conditions non-conformant to those recommended by manufacturer.
 - Customers shall be responsible for determining whether it is necessary to have back-up, failsafe and/or fool-proof protection To avoid or minimize damage that may result from extra-ordinary, irregular function or failure of PPTC devices.
 - Any and all responsibilities and liabilities are disclaimed if any item under this notice of warning is not complied with.

Thermal Derating Curve

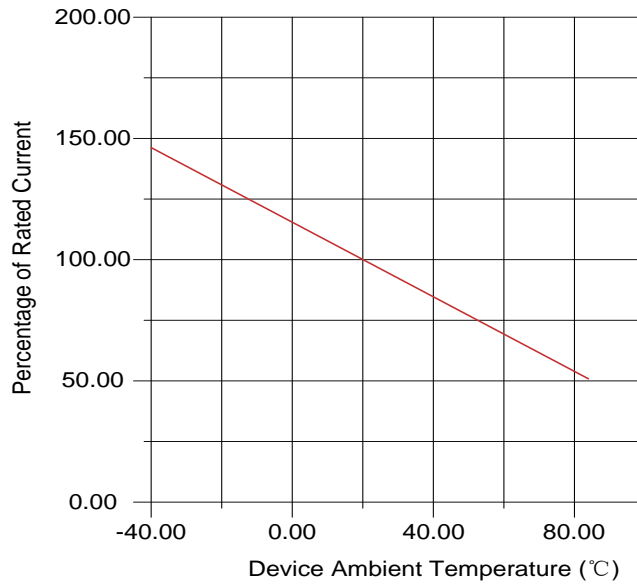

Thermal Derating Chart – I_H (A)

Part Number	Maximum Ambient Operating Temperatures (°C)									
	-40	-20	0	25	30	40	50	60	70	85
BK30-090	1.25	1.17	1.04	0.90	0.82	0.75	0.69	0.61	0.55	0.47
BK30-110	1.50	1.43	1.27	1.10	1.00	0.91	0.85	0.75	0.67	0.57
BK30-135	1.90	1.76	1.55	1.35	1.23	1.12	1.04	0.92	0.82	0.70
BK30-160	2.20	2.08	1.84	1.60	1.46	1.33	1.23	1.09	0.98	0.83
BK30-185	2.62	2.41	2.13	1.85	1.68	1.54	1.42	1.26	1.13	0.96
BK30-200	2.80	2.60	2.30	2.00	1.82	1.66	1.54	1.36	1.22	1.04
BK30-250	3.50	3.25	2.88	2.50	2.28	2.08	1.93	1.70	1.53	1.30
BK30-300	4.20	3.90	3.45	3.00	2.73	2.49	2.31	2.04	1.83	1.56
BK30-400	5.60	5.20	4.60	4.00	3.64	3.32	3.08	2.72	2.44	2.08
BK30-500	7.10	6.50	5.75	5.00	4.55	4.15	3.85	3.40	3.05	2.60
BK30-600	8.50	7.80	6.90	6.00	5.46	4.98	4.62	4.08	3.66	3.12
BK30-700	9.90	9.10	8.05	7.00	6.37	5.81	5.39	4.76	4.27	3.64
BK30-800	11.30	10.40	9.20	8.00	7.28	6.64	6.16	5.44	4.88	4.16
BK30-900	12.70	11.70	10.35	9.00	8.19	7.47	6.93	6.12	5.49	4.68

Test Procedures and Requirement

Items	Test Conditions	Accept/Reject Criteria
Resistance	In still air @25°C	$R_{min} \leq R \leq R_{max}$
Time to Trip	Specified current, V_{max} , 25°C	$T \leq \max. \text{ Time to trip } (T_{trip})$
Hold Current	30 min, at I_H	No trip
Trip Cycle Life	V_{max} , I_{max} , 100 cycles	No arcing or burning
Trip Endurance	V_{max} , 24hours	No arcing or burning

Typical Time-to-Trip Charts @25°C

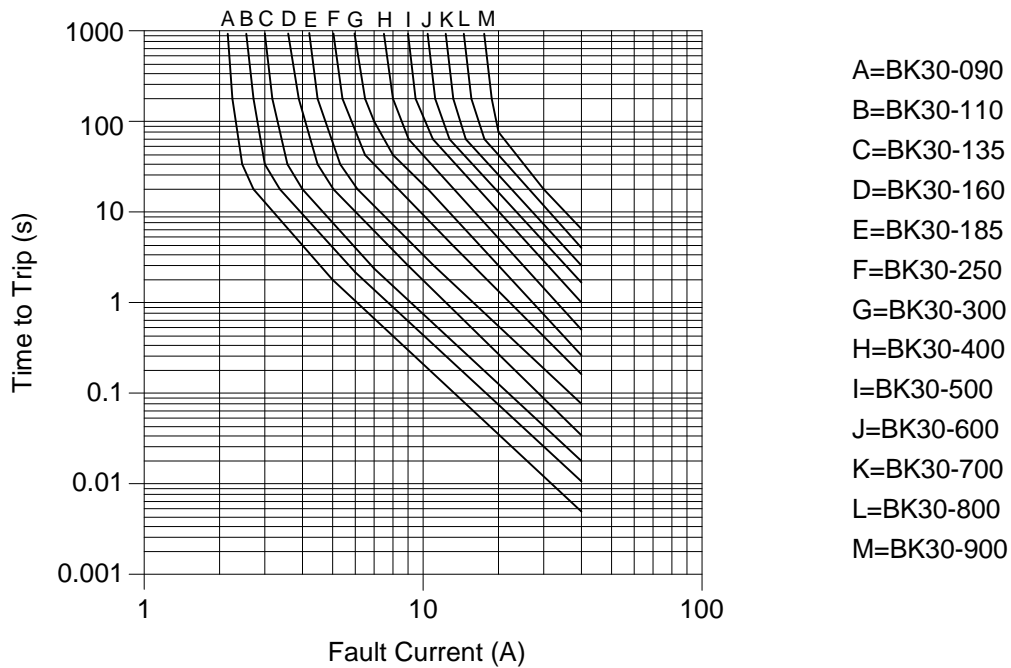

Storage Recommendations

- Storage Temperature: -10°C ~ +40°C
- Relative Humidity: ≤80%RH
- Keep away from corrosive atmosphere and sunlight.
- Period of Storage: 1 year.

Wave Soldering Recommendation Parameters

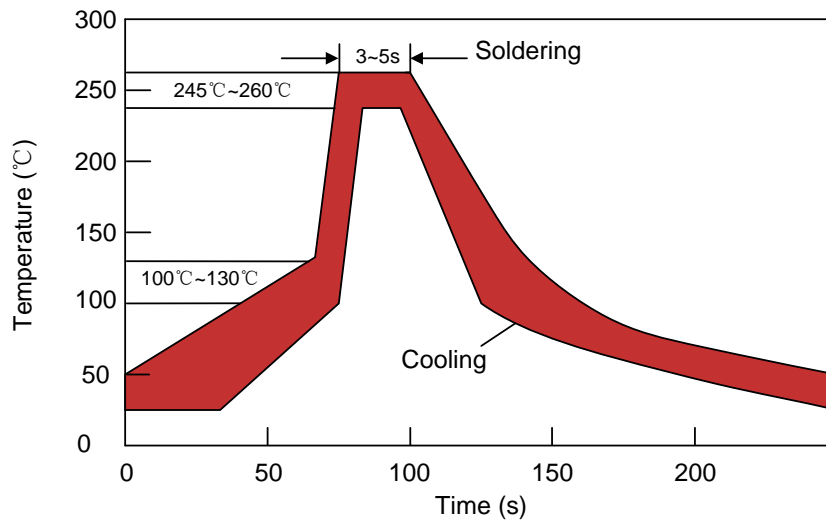

Items	Conditions
Pre-Heating Zone	Refer to the condition recommended by the flux manufacturer. Maximum ramping rate should not exceed 4°C/sec.
Soldering Zone	Maximum solder temperature should not exceed 260°C
Cooling Zone	Forced cooling

Manual Soldering Recommendation Parameters

Items	Conditions
Soldering condition	The highest power of the manual soldering iron should be 30W or less, soldering temperature should not be higher than 280°C.
Soldering time	The soldering time should be kept within 3 seconds, otherwise it might cause insulation layer cracking, and increased part resistance.
Soldering position	The distance on the leads between the soldering point and bottom of the PPTC body should be equal or greater than 4mm.
Other	The soldering iron should not contact the PPTC body except the leads. If the soldering conditions are kept to lower temperature, less time and larger distance, the outcome of the soldering will be better.

Mechanical Characteristics

Items	Specifications	Test Conditions/Methods
Tensile strength	No visible damage	1.0Kgf, 10 seconds
Bending strength	No visible damage	0.5Kgf, 90° , 3 times
Vibration	No visible damage	Freq: 10-55Hz, Amp: 0.75mm, 1min

Reliability Test

Items	Specifications	Test Conditions/Methods
Solder ability	No visible damage, Solder OK, Solder area $\geq 95\%$	$245\pm 5^{\circ}\text{C}$, $2\pm 1\text{s}$, dipping depth=0.5inch max from the body
Resistance to soldering heat	No visible damage, Electrical OK, $ \Delta R/R0 \leq 50\%$	$260\pm 5^{\circ}\text{C}$, $10+2/-0\text{s}$
Damp heat, steady state	No visible damage, Electrical OK, $ \Delta R/R0 \leq 20\%$	$40\pm 2^{\circ}\text{C}$, 90~95 % RH, total 48Hrs, after 4Hrs test electrical parameter
Temperature cycling	No visible damage, Electrical OK, $ \Delta R/R0 \leq 20\%$	$T_a = -10+0/-1^{\circ}\text{C}$ 30min, $T_a = 70+1/-0^{\circ}\text{C}$ 30min, 5cycles, after 1hr test electrical parameter

Packaging

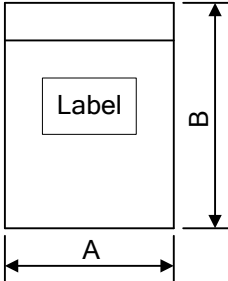
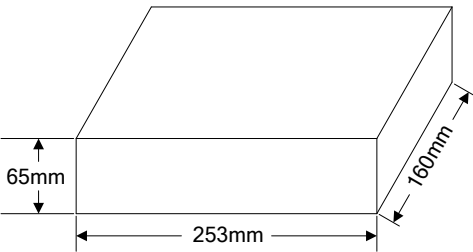
Bag	Part Number	Dimension AxB (mm)	Quantity
	BK30-090	120x150	1000pcs/bag 4000pcs/box
	BK30-110		
	BK30-135		
	BK30-160	150x200	
	BK30-185		
	BK30-200		
	BK30-250	150x200	500pcs/bag 2000pcs/box
	BK30-300	120x150	
	BK30-400	150x200	
	BK30-500		
	BK30-600	150x200	200pcs/bag 800pcs/box
	BK30-700		
	BK30-800		
	BK30-900		

X-ON Electronics

Largest Supplier of Electrical and Electronic Components

Click to view similar products for [Resettable Fuses - PPTC](#) category:

Click to view products by [Brightking](#) manufacturer:

Other Similar products are found below :

[0001.1010.G](#) [D38999/20WG39JN](#) [F02B250V1-4AS](#) [9728214S-2\(621\)](#) [RF0627-000](#) [RF2534-000](#) [ASMD185-2](#) [EN2997S61212AN](#)
[EN2997SE61203AN](#) [BK-ABC-V-5-R](#) [LR4-550RAF](#) [SMD125-2](#) [F60C500V20AS](#) [RF0078-000](#) [RF1548-000](#) [RF1973-000](#) [RF2171-000](#)
[RF2531-000](#) [RF2533-000](#) [RF2550-000](#) [TR600-150Q-B-0.5-0.130](#) [BK-AGX-20](#) [5E4795/04-1502](#) [EN2997S61212MN](#) [EN2997SE61203MN](#)
[EN2997SE61212AN](#) [EN2997SE61212MN](#) [BK1/S505-1.25-R](#) [TR-3216FF20-R](#) [TRF250-080T-B-1.0-0.125](#) [JT06RT1832BN014](#) [S-3-2-10](#)
[SMD100-2](#) [FRN-R-5-6-10](#) [FRS-R-3-2-10](#) [LP-CC-2-1-2](#) [LPS-RK-3-2-10SP](#) [BK-AGC-1-8-R](#) [BK-AGC-2-10-R](#) [BK-AGC-7-1-2](#) [BK-GDC-](#)
[500MA](#) [BK-MDL-1-6-10-R](#) [BK-SFE-4](#) [BK-ABC-1-R](#) [BK-C518-250-R](#) [BK-GDB-2A](#) [BK-MDL-1-8-R](#) [BK-MDL-6](#) [BK-AGC-5-R](#) [BK-ATC-](#)