

## 5082-761x/-762x/-765x/-766x Series, HDSP-360x/-460x/-E15x Series

### 7.6 mm (0.3 inch)/10.9 mm (0.43 inch) Seven-Segment Displays

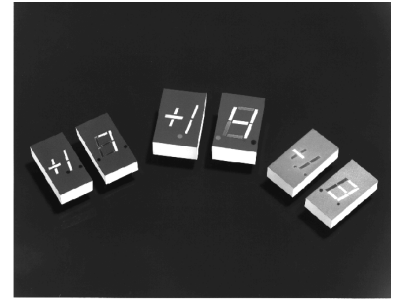

### Description

The 7.6 mm (0.3 inch) and 10.9 mm (0.43 inch) LED seven-segment displays are designed for viewing distances up to 3 meters (10 feet) and 5 meters (16 feet). These devices use an industry standard size package and pinouts. All devices are available as either common anode or common cathode.

### Features

- Industry standard size
- Industry standard pinout
  - 7.62 mm (0.300 inch) DIP leads on 2.54 mm (0.100 inch) centers
- Choice of colors
  - AlGaAs Red, High Efficiency Red, Yellow, Green
- Excellent appearance
  - Evenly lighted segments
  - $\pm 50^\circ$  viewing angle
  - Optimum contrast given by gray top surface for AlGaAs Red and Green devices
  - Red top surface for HER devices
  - Yellow top surface for yellow devices
- Design flexibility
  - Common anode or common cathode
  - Single digits
  - Left or right hand decimal point  $\pm 1$ . overflow character
- Categorized for luminous intensity
  - Yellow and Green categorized for color
  - Use of like categories yields a uniform display
- High light output
- High peak current
- Excellent for long digit string multiplexing
- Intensity and color selection available
  - Refer to the *Intensity and Color Selected Displays Data Sheet*
- Sunlight viewable AlGaAs

## Devices

AlGaAs <sup>a</sup> Red HDSP-	HER <sup>a</sup> 5082-	Yellow 5082-	Green HDSP-	Description	Package Drawing
	7610	7620	3600	7.6 mm Common Anode Left Hand Decimal	A
	7611	7621	3601	7.6 mm Common Anode Right Hand Decimal	B
	7613	7623	3603	7.6 mm Common Cathode Right Hand Decimal	C
	7650		4600	10.9 mm Common Anode Left Hand Decimal	E
E151	7651	7661	4601	10.9 mm Common Anode Right Hand Decimal	F
E153	7653	7663	4603	10.9 mm Common Cathode Right Hand Decimal	G
	7656	7666	4606	10.9 mm Universal ± 1. Overflow Right Hand Decimal <sup>b</sup>	H

- a. These displays are recommended for high ambient light operation. Refer to the HDSP-335X HER data sheet for low current operation.  
 b. Universal pinout brings the anode and cathode of each segment's LED out to separate pins. See internal diagram H.

## Part Number

5082 - X XX X - X X X X  
 HDSP - X XX X - X X X X

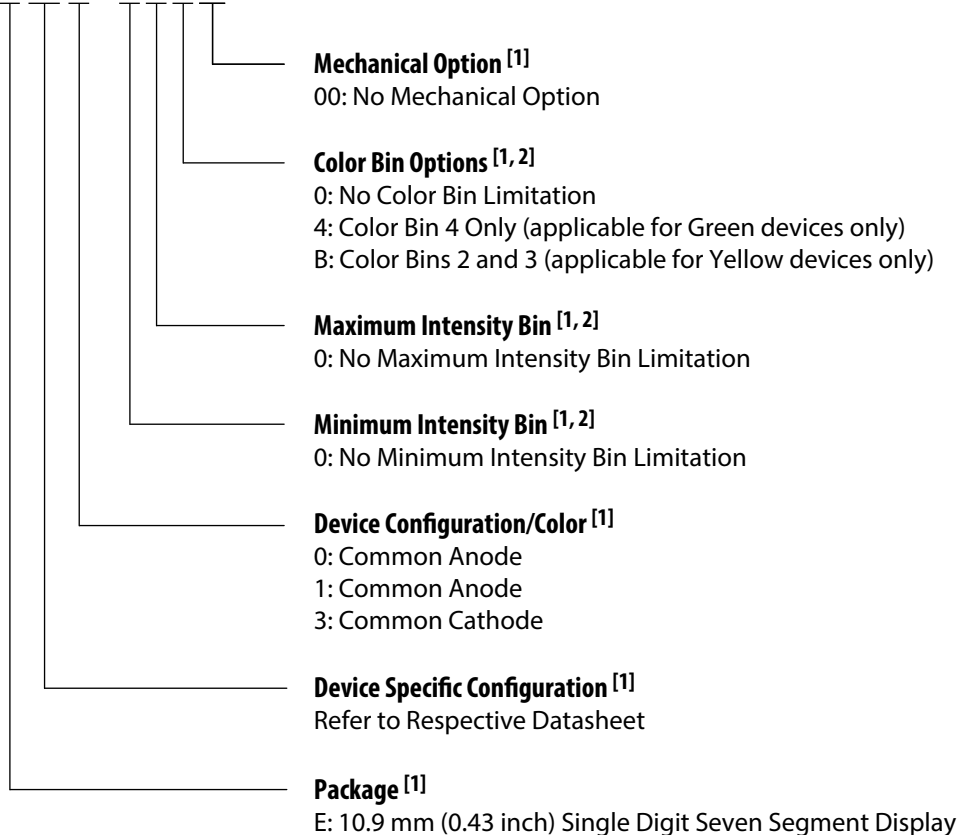

### NOTE:

- For codes not listed in the figure above, please refer to the respective datasheet or contact your nearest Broadcom representative for details.
- Bin options refer to shippable bins for a part number. Color and Intensity Bins are typically restricted to one bin per tube (exceptions may apply). Refer to respective data sheet for specific bin limit information.

These displays are ideal for most displays are ideal for portable applications. Pin for pin equiva-applications. The high light lent displays are also available in ambient displays are ideal for a low current or high light high light ambients or long string ambient design. The low current lengths. For additional information, refer to the Low Current Seven Segment Displays, or High Light Ambient Seven Segment Displays data sheets.

## Package Dimensions

### Package Dimensions

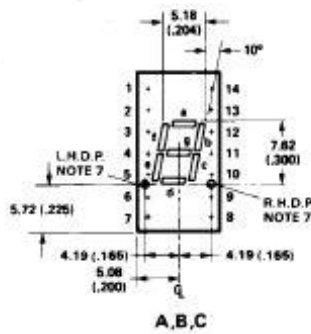

A, B, C

PIN	FUNCTION		
	A	B	C
1	CATHODE-a	CATHODE-a	NO PIN
2	CATHODE-f	CATHODE-f	CATHODE <sup>(1)</sup>
3	ANODE <sup>(2)</sup>	ANODE <sup>(2)</sup>	ANODE-f
4	NO PIN	NO PIN	ANODE-g
5	NO PIN	NO PIN	ANODE-e
6	CATHODE-dp	NO CONN. <sup>(3)</sup>	ANODE-d
7	CATHODE-e	CATHODE-e	NO PIN
8	CATHODE-d	CATHODE-d	NO PIN
9	NO CONN. <sup>(3)</sup>	CATHODE-dp	CATHODE <sup>(1)</sup>
10	CATHODE-c	CATHODE-c	ANODE-dp
11	CATHODE-g	CATHODE-g	ANODE-c
12	NO PIN	NO PIN	ANODE-b
13	CATHODE-b	CATHODE-b	ANODE-a
14	ANODE <sup>(2)</sup>	ANODE <sup>(2)</sup>	NO PIN

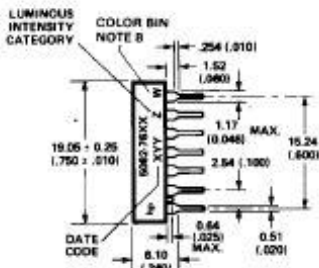

A, B SIDE

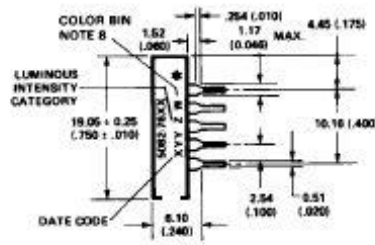

C SIDE

\*The Side View of package indicates Country of Origin.

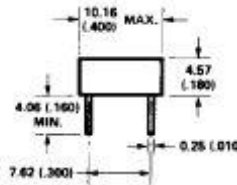

A, B, C END

- NOTES:
1. DIMENSIONS IN MILLIMETRES AND (INCHES).
  2. ALL UNTOLERANCED DIMENSIONS ARE FOR REFERENCE ONLY.
  3. REDUNDANT ANODES.
  4. UNUSED DP POSITION.
  5. SEE INTERNAL CIRCUIT DIAGRAM.
  6. REDUNDANT CATHODE.
  7. SEE PART NUMBER TABLE FOR L.H.D.P. AND R.H.D.P. DESIGNATION.
  8. FOR YELLOW AND GREEN DEVICES ONLY.

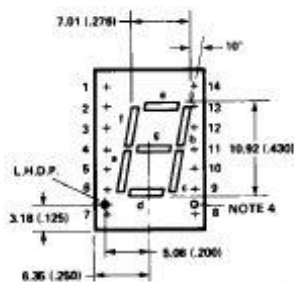

E

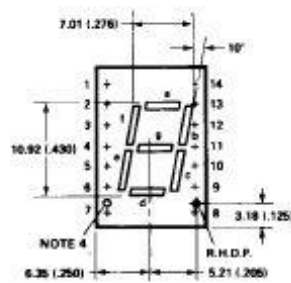

F, G FRONT VIEW

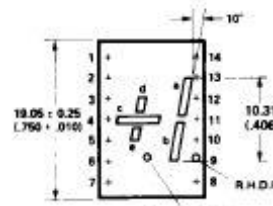

H

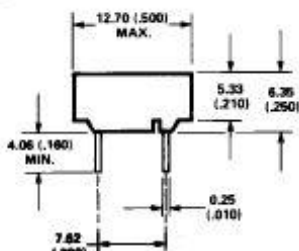

END VIEW

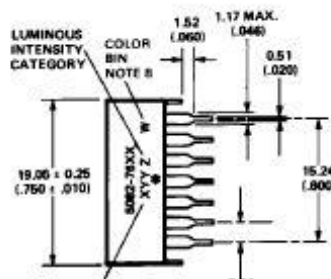

SIDE VIEW

\*The Side View of package indicates Country of Origin.

PIN	FUNCTION			
	E	F	G	H
1	CATHODE-a	CATHODE-a	ANODE-a	CATHODE-d
2	CATHODE-f	CATHODE-f	ANODE-f	ANODE-d
3	ANODE <sup>(2)</sup>	ANODE <sup>(2)</sup>	CATHODE <sup>(1)</sup>	NO PIN
4	NO PIN	NO PIN	NO PIN	CATHODE-c
5	NO PIN	NO PIN	NO PIN	CATHODE-e
6	CATHODE-dp	NO CONN. <sup>(3)</sup>	NO CONN. <sup>(3)</sup>	ANODE-e
7	CATHODE-e	CATHODE-e	ANODE-e	ANODE-c
8	CATHODE-d	CATHODE-d	ANODE-d	ANODE-dp
9	NO CONN. <sup>(3)</sup>	CATHODE-dp	ANODE-dp	CATHODE-dp
10	CATHODE-c	CATHODE-c	ANODE-c	CATHODE-b
11	CATHODE-g	CATHODE-g	ANODE-g	CATHODE-a
12	NO PIN	NO PIN	NO PIN	NO PIN
13	CATHODE-b	CATHODE-b	ANODE-b	ANODE-a
14	ANODE <sup>(2)</sup>	ANODE <sup>(2)</sup>	CATHODE <sup>(1)</sup>	ANODE-b

## Internal Circuit Diagram

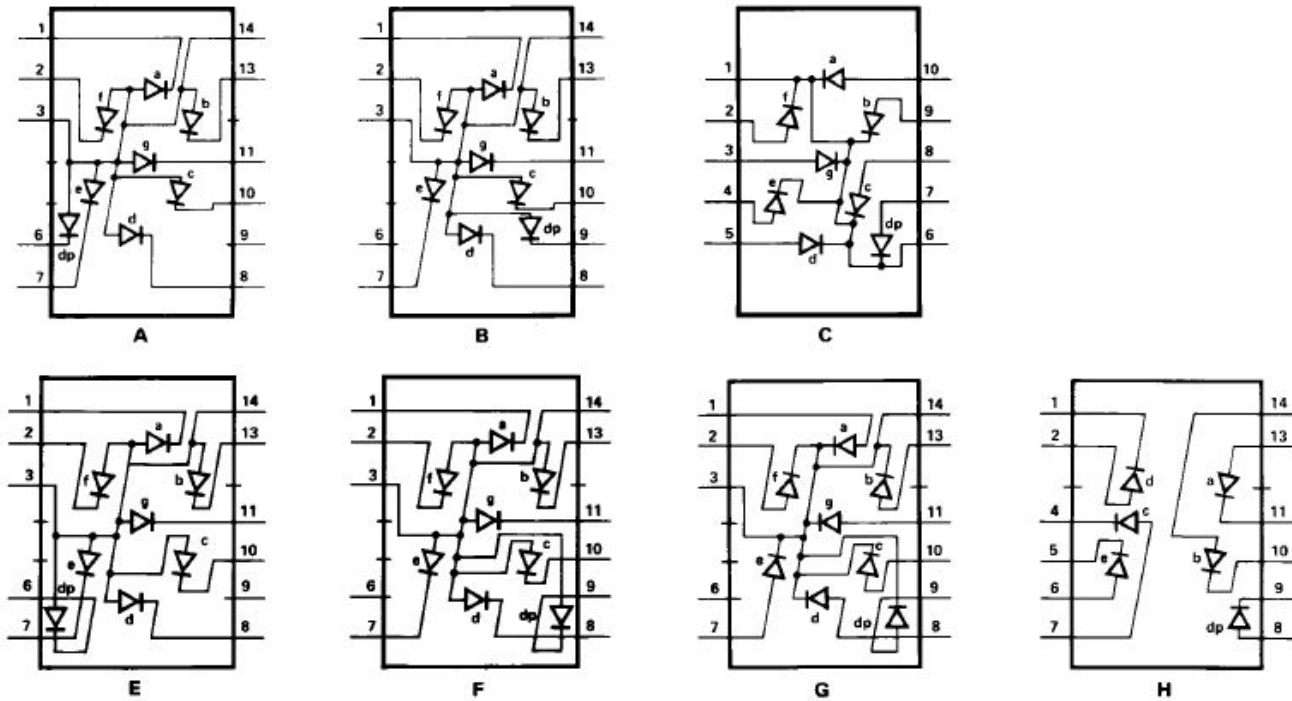

## Absolute Maximum Ratings

Description	AlGaAs Red HDSP-E150 Series	HER 5082- 7610/7650 Series	Yellow 5082- 7620/7660 Series	Green HDSP- 3600/4600 Series	Units
Average Power per Segment or DP	96	105	80	105	mW
Peak Forward Current per Segment or DP	160 <sup>a</sup>	90 <sup>b</sup>	60 <sup>c</sup>	90 <sup>d</sup>	mA
DC Forward Current per Segment or DP	40 <sup>e</sup>	30 <sup>f</sup>	20 <sup>g</sup>	30 <sup>h</sup>	mA
Operating Temperature Range	-20 to +100 <sup>i</sup>	-40 to +100			°C
Storage Temperature Range		-55 to +100			°C
Reverse Voltage <sup>j</sup> per Segment or DP		3.0V			V
Wave Soldering Temperature for 3s (1.59 mm [0.063 in.] below Body)		250			°C

- a. See Figure 1 to establish pulsed conditions.
- b. See Figure 6 to establish pulsed conditions.
- c. See Figure 7 to establish pulsed conditions.
- d. See Figure 8 to establish pulsed conditions.
- e. Derate above 46°C at 0.54 mA/°C.
- f. Derate above 53°C at 0.45 mA/°C.
- g. Derate above 81°C at 0.52 mA/°C.
- h. Derate above 39°C at 0.37 mA/°C.
- i. For operation below -20°C, contact your local Broadcom components sales office or an authorized distributor.
- j. Reverse voltage is for LED testing purposes and is not recommended to be used as application condition.

## Electrical/Optical Characteristics at $T_A = 25^\circ\text{C}$

### AlGaAs Red

Device Series	Parameter	Symbol	Min.	Typ.	Max.	Units	Test Conditions
HDSP-E15x	Luminous Intensity/Segment <sup>a, b, c</sup> (Digit Average)	$I_V$	8.5	15.0	—	mcd	$I_F = 20\text{ mA}$
	Forward Voltage/Segment or DP	$V_F$	—	1.8	—	V	$I_F = 20\text{ mA}$
			—	2.0	3.0	V	$I_F = 100\text{ mA}$
	Peak Wavelength	$\lambda_{\text{PEAK}}$	—	645	—	nm	
	Dominant Wavelength <sup>d</sup>	$\lambda_d$	—	637	—	nm	
	Reverse Voltage/Segment or DP <sup>e</sup>	$V_R$	3.0	15	—	V	$I_R = 100\text{ }\mu\text{A}$
	Temperature Coefficient of $V_F$ /Segment or DP	$\Delta V_F/^\circ\text{C}$	—	-2	—	mV/°C	
Thermal Resistance LED Junction-to-Pin	$R\theta_{\text{J-PIN}}$	—	340	—	°C/W/Seg		

- Device case temperature is  $25^\circ\text{C}$  prior to the intensity measurement.
- The digits are categorized for luminous intensity. The intensity category is designated by a letter on the side of the package.
- For low current operation, the AlGaAs HDSP-E10X series displays are recommended. They are tested at 1 mA dc/segment and are pin for pin compatible with the HDSP-E15X series.
- The dominant wavelength,  $\lambda_d$ , is derived from the CIE chromaticity diagram and is that single wavelength which defines the color of the device.
- Typical specification for reference only. Do not exceed absolute maximum ratings.

### High Efficiency Red

Device Series	Parameter	Symbol	Min.	Typ.	Max.	Units	Test Conditions
5082-761x	Luminous Intensity/Segment <sup>a, b, c</sup> (Digit Average)	$I_V$	340	800	—	$\mu\text{cd}$	$I_F = 5\text{ mA}$
5082-765x			340	1115	—	$\mu\text{cd}$	$I_F = 5\text{ mA}$
All	Forward Voltage/Segment or DP	$V_F$	—	2.1	2.5	V	$I_F = 20\text{ mA}$
	Peak Wavelength	$\lambda_{\text{PEAK}}$	—	635	—	nm	
	Dominant Wavelength <sup>d</sup>	$\lambda_d$	—	626	—	nm	
	Reverse Voltage/Segment or DP <sup>e</sup>	$V_R$	3.0	30	—	V	$I_R = 100\text{ }\mu\text{A}$
	Temperature Coefficient of $V_F$ /Segment or DP	$\Delta V_F/^\circ\text{C}$	—	-2	—	mV/°C	
Thermal Resistance LED Junction-to-Pin	$R\theta_{\text{J-PIN}}$	—	280	—	°C/W/Seg		

- Device case temperature is  $25^\circ\text{C}$  prior to the intensity measurement.
- The digits are categorized for luminous intensity. The intensity category is designated by a letter on the side of the package.
- For low current operation, the HER HDSP-335X series displays are recommended. They are tested at 2 mA dc/segment and are pin for pin compatible with the 5082-7650 series.
- The dominant wavelength,  $\lambda_d$ , is derived from the CIE chromaticity diagram and is that single wavelength which defines the color of the device.
- Typical specification for reference only. Do not exceed absolute maximum ratings.

## Yellow

Device Series	Parameter	Symbol	Min.	Typ.	Max.	Units	Test Conditions
5082-762x	Luminous Intensity/Segment <sup>a, b</sup> (Digit Average)	$I_V$	205	620	—	$\mu\text{cd}$	$I_F = 5 \text{ mA}$
5082-766x			290	835	—	$\mu\text{cd}$	$I_F = 5 \text{ mA}$
All	Forward Voltage/Segment or DP	$V_F$	—	2.2	2.5	V	$I_F = 20 \text{ mA}$
	Peak Wavelength	$\lambda_{\text{PEAK}}$	—	583	—	nm	
	Dominant Wavelength <sup>c, d</sup>	$\lambda_d$	581.5	586	592.5	nm	
	Reverse Voltage/Segment or DP <sup>e</sup>	$V_R$	3.0	40	—	V	$I_R = 100 \mu\text{A}$
	Temperature Coefficient of $V_F$ /Segment or DP	$\Delta V_F / ^\circ\text{C}$	—	-2	—	mV/ $^\circ\text{C}$	
	Thermal Resistance LED Junction-to-Pin	$R_{\theta_{\text{J-PIN}}}$	—	280	—	$^\circ\text{C/W/Seg}$	

- Device case temperature is 25°C prior to the intensity measurement.
- The digits are categorized for luminous intensity. The intensity category is designated by a letter on the side of the package.
- The dominant wavelength,  $\lambda_d$ , is derived from the CIE chromaticity diagram and is that single wavelength which defines the color of the device.
- The Yellow (5082-7620/7660) and Green (HDSP-3600/4600) displays are categorized for dominant wavelength. The category is designated by a number adjacent to the luminous intensity category letter.
- Typical specification for reference only. Do not exceed absolute maximum ratings.

## High Performance Green

Device Series	Parameter	Symbol	Min.	Typ.	Max.	Units	Test Conditions
HDSP-360x	Luminous Intensity/Segment <sup>a, b</sup> (Digit Average)	$I_V$	860	2700	—	$\mu\text{cd}$	$I_F = 10 \text{ mA}$
HDSP-460x			1030	4000	—	$\mu\text{cd}$	$I_F = 10 \text{ mA}$
All	Forward Voltage/Segment or DP	$V_F$	—	2.1	2.5	V	$I_F = 10 \text{ mA}$
	Peak Wavelength	$\lambda_{\text{PEAK}}$	—	566	—	nm	
	Dominant Wavelength <sup>c, d</sup>	$\lambda_d$	—	571	577	nm	
	Reverse Voltage/Segment or DP <sup>e</sup>	$V_R$	3.0	50	—	V	$I_R = 100 \mu\text{A}$
	Temperature Coefficient of $V_F$ /Segment or DP	$\Delta V_F / ^\circ\text{C}$	—	-2	—	mV/ $^\circ\text{C}$	
	Thermal Resistance LED Junction-to-Pin	$R_{\theta_{\text{J-PIN}}}$	—	280	—	$^\circ\text{C/W/Seg}$	

- Device case temperature is 25°C prior to the intensity measurement.
- The digits are categorized for luminous intensity. The intensity category is designated by a letter on the side of the package.
- The dominant wavelength,  $\lambda_d$ , is derived from the CIE chromaticity diagram and is that single wavelength which defines the color of the device.
- The Yellow (5082-7620/7660) and Green (HDSP-3600/4600) displays are categorized for dominant wavelength. The category is designated by a number adjacent to the luminous intensity category letter.
- Typical specification for reference only. Do not exceed absolute maximum ratings.

# AlGaAs Red

Figure 1: Maximum Allowed Peak Current vs. Pulse Duration – AlGaAs Red

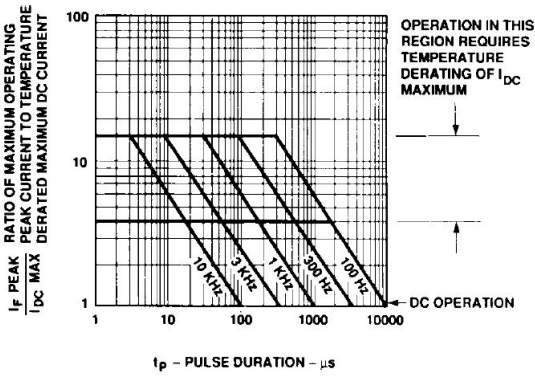

Figure 2: Maximum Allowable DC Current vs. Ambient Temperature

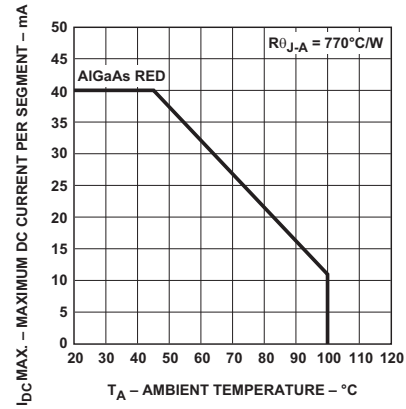

Figure 3: Forward Current vs. Forward Voltage

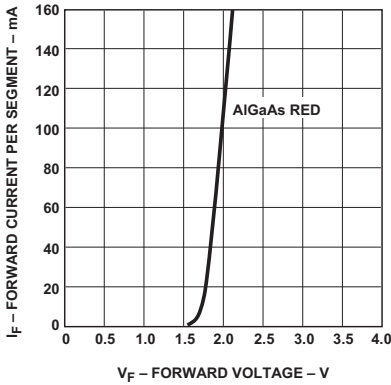

Figure 4: Relative Luminous Intensity vs. DC Forward Current

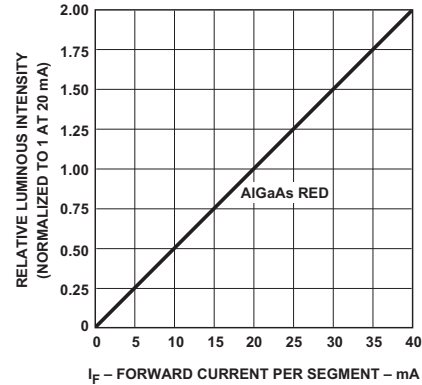
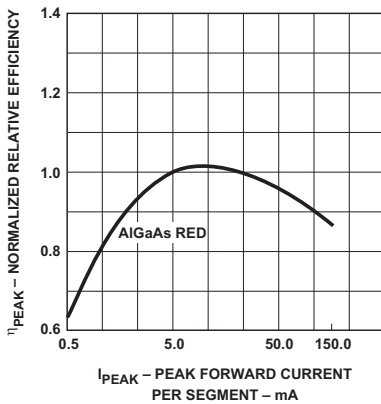

Figure 5: Relative Efficiency (Luminous Intensity per Unit Current) vs. Peak Current





# HER, Yellow, Green

Figure 6: Maximum Tolerable Peak Current vs. Pulse Duration – HER Series

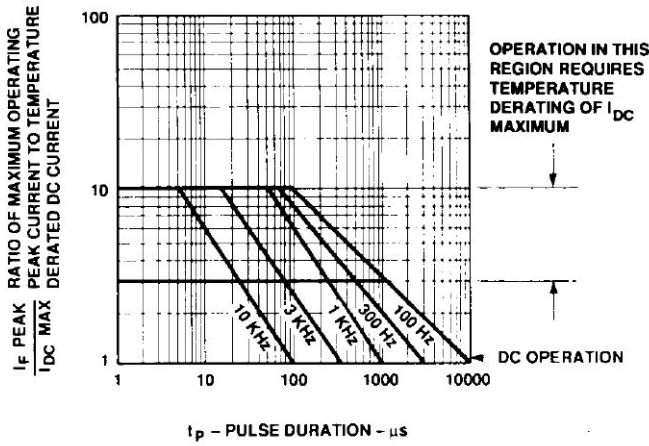

Figure 7: Maximum Tolerable Peak Current vs. Pulse Duration – Yellow Series

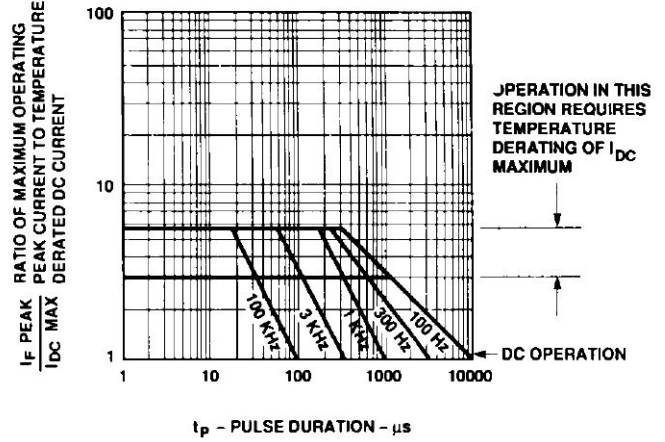

Figure 8: Allowable Peak Current vs. Pulse Duration – Green Series

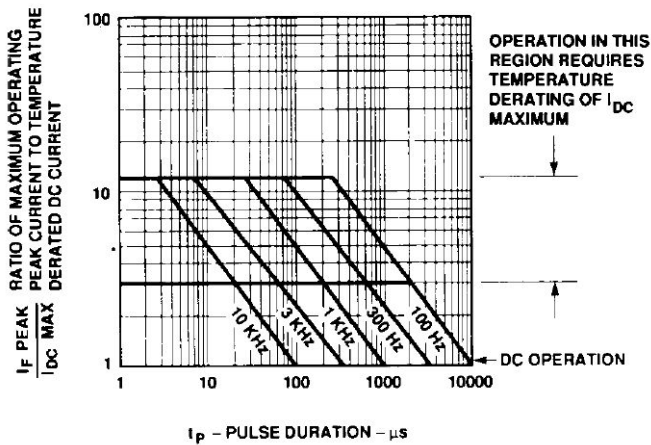

Figure 9: Maximum Allowable DC Current vs. Ambient Temperature

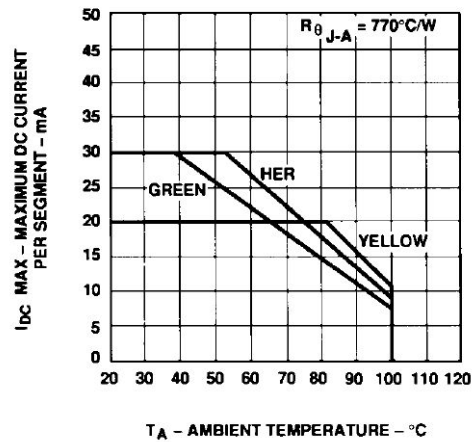



Figure 10: Forward Current vs. Forward Voltage

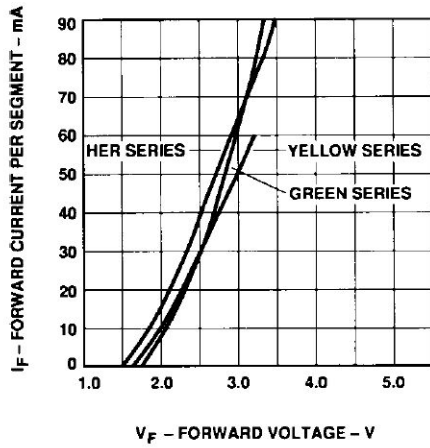

Figure 12: Relative Luminous Efficiency (Luminous Intensity per Unit Current) vs. Peak Current

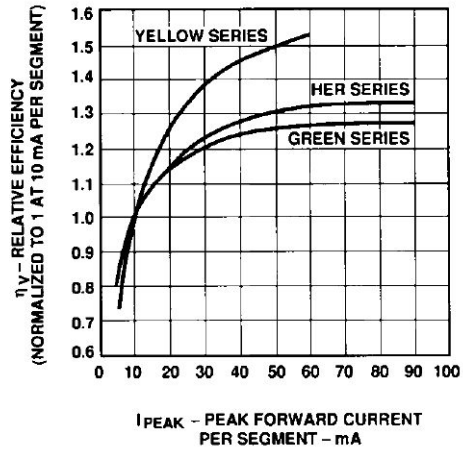
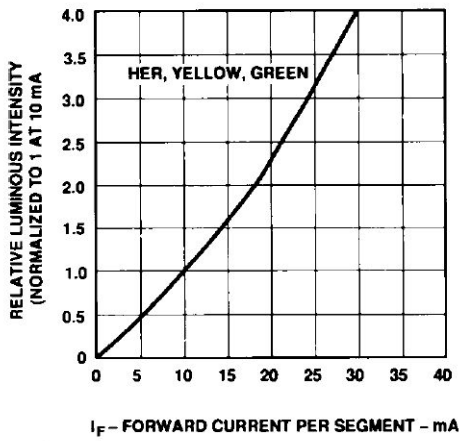

Figure 11: Relative Luminous Intensity vs. DC Forward Current



## Intensity Bin Limits (mcd)

### AlGaAs Red

HDSP-E15x		
IV Bin Category	Min.	Max.
L	8.67	15.90
M	13.00	23.80
N	19.50	35.80
O	29.30	53.60
P	43.90	80.50

### HER

5082-761x		
IV Bin Category	Min.	Max.
B	0.369	0.630
C	0.516	0.946
D	0.774	1.418
E	1.160	2.127
F	1.740	3.190
G	2.610	4.785
H	3.915	7.177

5082-765x		
IV Bin Category	Min.	Max.
B	0.347	0.593
C	0.485	0.890
D	0.728	1.333
E	1.091	2.000
F	1.636	3.000
G	2.454	4.500
H	3.682	6.751

### Yellow

5082-762x		
IV Bin Category	Min.	Max.
B	0.229	0.387
C	0.317	0.582
D	0.476	0.872
E	0.714	1.311
F	1.073	1.967
G	1.609	2.950
H	2.413	4.425

5082-766x		
IV Bin Category	Min.	Max.
C	0.297	0.543
D	0.445	0.817
E	0.669	1.225
F	1.003	1.838
G	1.504	2.758
H	2.256	4.137

## Green

HDSP-360x		
IV Bin Category	Min.	Max.
H	0.86	1.58
I	1.29	2.37
J	1.94	3.55
K	2.90	5.33
L	4.37	8.01

HDSP-460x		
IV Bin Category	Min.	Max.
G	1.03	1.88
H	1.54	2.82
I	2.31	4.23
J	3.46	6.34
K	5.18	9.50
L	7.78	14.26

## Color Categories

Color	Bin	Dominant Wavelength (nm)	
		Min.	Max.
Yellow	1	581.50	585.00
	3	584.00	587.50
	2	586.50	590.00
	4	589.00	592.50
Green	2	573.00	577.00
	3	570.00	574.00
	4	567.00	571.00
	5	564.00	568.00

**NOTE:** All categories are established for classification of products. Products may not be available in all categories. Please contact your Broadcom representatives for further clarification/information.

## Contrast Enhancement

For information on contrast enhancement, refer to Application Note 1015.

## Soldering and Cleaning

For information on soldering LEDs, refer to Application Note 1027.

Broadcom, the pulse logo, Connecting everything, Avago Technologies, Avago, and the A logo are among the trademarks of Broadcom and/or its affiliates in the United States, certain other countries, and/or the EU.

Copyright © 2006–2018 Broadcom. All Rights Reserved.

The term “Broadcom” refers to Broadcom Inc. and/or its subsidiaries. For more information, please visit [www.broadcom.com](http://www.broadcom.com).

Broadcom reserves the right to make changes without further notice to any products or data herein to improve reliability, function, or design. Information furnished by Broadcom is believed to be accurate and reliable. However, Broadcom does not assume any liability arising out of the application or use of this information, nor the application or use of any product or circuit described herein, neither does it convey any license under its patent rights nor the rights of others.



## X-ON Electronics

Largest Supplier of Electrical and Electronic Components

*Click to view similar products for [LED Displays & Accessories](#) category:*

*Click to view products by [Broadcom](#) manufacturer:*

Other Similar products are found below :

[LTC-2721WC](#) [LTC-4624JD](#) [LTC-4627WC](#) [LTC-571P](#) [LTD-5021AWC](#) [LTM-8522G](#) [LTP-4323P](#) [LTP-747G](#) [LTS-3361JG-06](#) [ELS-316SYGWA/S530-E2](#) [1668](#) [HT-F196NB-5323](#) [IPD2131-27](#) [LDQ-N514RI](#) [LDS-A3506RD](#) [LDS-A3926RI](#) [SC03-12HDB](#) [SI-B9T151550WW](#) [SI-B9V171550WW](#) [SLC-3PF-WL](#) [SLDN-32M-G](#) [1624](#) [LTC-2623WC](#) [LTC-4627JD](#) [LTD-322G](#) [LTD-482PC](#) [LTP-1057AHR](#) [LTP-1457AKR](#) [LTP-3784G-01](#) [LTS-313AP](#) [LTS-4812SKR-P](#) [LTS-547AE](#) [LTS-6780P](#) [446010401-3](#) [HV-7W30-6829](#) [DA43-11GWA](#) [LDD-A516RI-17](#) [LDD-E305RI](#) [LDQ-N3402RI](#) [LDQ-N3606RI](#) [LDT-M2804RI](#) [86004CB830](#) [LTP-3862JD](#) [LTP-2088AKD](#) [LTD-6740P](#) [LTS-6880Y](#) [LDS-SMC3002RISUGTR](#) [LTC-2623E](#) [CC25-12YWA](#) [LDM-6432-P3-UR-1](#)