

ADA-4743

Silicon Bipolar Darlington Amplifier



Data Sheet

Description

Avago Technologies' ADA-4743 is an economical, easy-to-use, general purpose silicon bipolar RFIC gain block amplifiers housed in a 4-lead SC-70 (SOT-343) surface mount plastic package which requires only half the board space of a SOT-143 package.

The Darlington feedback structure provides inherent broad bandwidth performance, resulting in useful operating frequency up to 2.5 GHz. This is an ideal device for small-signal gain cascades or IF amplification.

ADA-4743 is fabricated using Avago's HP25 silicon bipolar process, which employs a double-diffused single polysilicon process with self-aligned submicron emitter geometry. The process is capable of simultaneous high f_T and high NPN breakdown (25 GHz f_T at 6V BVCEO). The process utilizes industry standard device oxide isolation technologies and submicron aluminum multilayer interconnect to achieve superior performance, high uniformity, and proven reliability.

SOT-343 Surface Mount Package

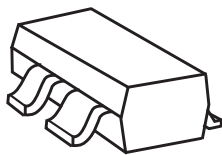

Pin Connections and Package Marking

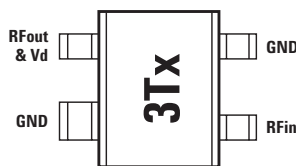

Note:

Top View. Package marking provides orientation and identification.

"3T" = Device Code

"x" = Date code character

identifies month of manufacture.

Features

- Small Signal gain amplifier
- Operating frequency DC – 2.5 GHz
- Unconditionally stable
- 50 Ohms input & output
- Flat, Broadband Frequency Response up to 1 GHz
- Operating Current: 40 to 80 mA
- Industry standard SOT-343 package
- Lead-free option available

Specifications

900 MHz, 3.8V, 60 mA (typ.)

- 16.5 dB associated gain
- 17.1 dBm P_{1dB}
- 32.6 dBm OIP₃
- 4.2 dB noise figure
- VSWR < 2 throughput operating frequency
- Single supply, typical $I_d = 60$ mA

Applications

- Cellular/PCS/WLL base stations
- Wireless data/WLAN
- Fiber-optic systems
- ISM



Attention:

Observe precautions for handling electrostatic sensitive devices.
 ESD Machine Model (Class A)
 ESD Human Body Model (Class 1B)
 Refer to Avago Application Note A004R:
 Electrostatic Discharge Damage and Control.

Typical Biasing Configuration

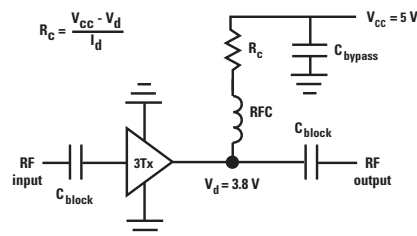

ADA-4743 Absolute Maximum Ratings^[1]

Symbol	Parameter	Units	Absolute Maximum
I_d	Device Current	mA	90
P_{diss}	Total Power Dissipation ^[2]	mW	370
$P_{in\ max.}$	RF Input Power	dBm	20
T_j	Channel Temperature	°C	150
T_{STG}	Storage Temperature	°C	-65 to 150
θ_{jc}	Thermal Resistance ^[3]	°C/W	163

Notes:

1. Operation of this device above any one of these parameters may cause permanent damage.
2. Ground lead temperature is 25°C. Derate 6.1 mW/°C for $T_L > 89^\circ\text{C}$.
3. Junction-to-case thermal resistance measured using 150°C Liquid Crystal Measurement method.

ADA-4743 Electrical Specifications

$T_A = 25^\circ\text{C}$, $Z_o = 50\Omega$, $P_{in} = -25\ \text{dBm}$, $I_d = 60\ \text{mA}$ (unless specified otherwise)

Symbol	Parameter and Test Condition: $I_d = 60\ \text{mA}$, $Z_o = 50\Omega$	Frequency	Units	Min.	Typ.	Max.	Std. Dev.
V_d	Device Voltage $I_d = 60\ \text{mA}$		V	3.3	3.8	4.3	
G_p	Power Gain ($ S_{21} ^2$)	100 MHz 900 MHz ^[1,2]	dB	15	16.6 16.5	18	
ΔG_p	Gain Flatness	100 to 900 MHz 0.1 to 2 GHz	dB		0.5 1.5		
F_{3dB}	3 dB Bandwidth		GHz		4		
$VSWR_{in}$	Input Voltage Standing Wave Ratio	0.1 to 6 GHz			1.7:1		
$VSWR_{out}$	Output Voltage Standing Wave Ratio	0.1 to 6 GHz			1.5:1		
NF	50Ω Noise Figure	100 MHz 900 MHz ^[1,2]	dB		4.1 4.2		0.11 0.16
P_{1dB}	Output Power at 1dB Gain Compression	100 MHz 900 MHz ^[1,2]	dBm		17.7 17.1		
OIP_3	Output 3 rd Order Intercept Point	100 MHz ^[3] 900 MHz ^[1,2,3]	dBm		33.4 32.6		
DV/dT	Device Voltage Temperature Coefficient		mV/°C		-4.9		

Notes:

1. Typical value determined from a sample size of 500 parts from 3 wafers.
2. Measurement obtained using production test board described in the block diagram below.
3. I) 900 MHz OIP_3 test condition: $F_1 = 900\ \text{MHz}$, $F_2 = 905\ \text{MHz}$ and $P_{in} = -25\ \text{dBm}$ per tone.
II) 100 MHz OIP_3 test condition: $F_1 = 100\ \text{MHz}$, $F_2 = 105\ \text{MHz}$ and $P_{in} = -25\ \text{dBm}$ per tone.

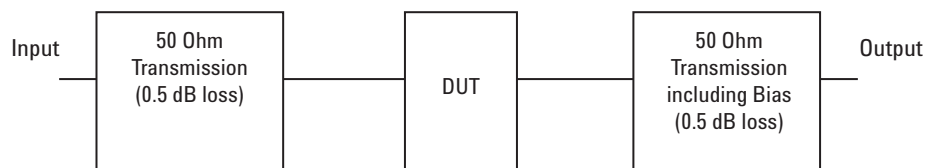

Block diagram of 900 MHz production test board used for V_d , Gain, P_{1dB} , OIP_3 , and NF measurements. Circuit losses have been de-embedded from actual measurements.

Product Consistency Distribution Charts at 900 MHz, $I_d = 60$ mA

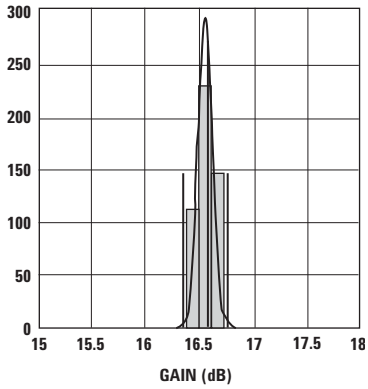

**Figure 1. Gain distribution @ 60 mA.
LSL=15, Nominal=16.5, USL=18**

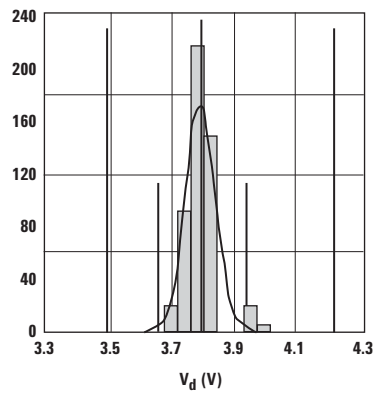

**Figure 2. V_d distribution @ 60 mA.
LSL=3.3, Nominal=3.8, USL=4.3**

Notes:

1. Statistics distribution determined from a sample size of 500 parts taken from 3 different wafers.
2. Future wafers allocated to this product may have typical values anywhere between the minimum and maximum specification limits.

ADA-4743 Typical Performance Curves (at 25°C, unless specified otherwise)

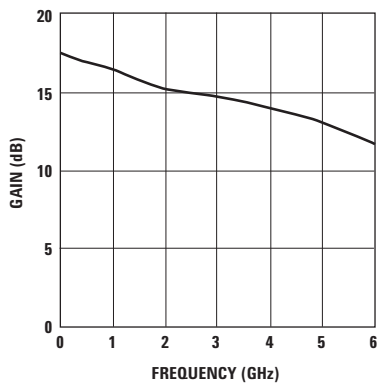

Figure 3. Gain vs. Frequency at $I_d = 60$ mA.

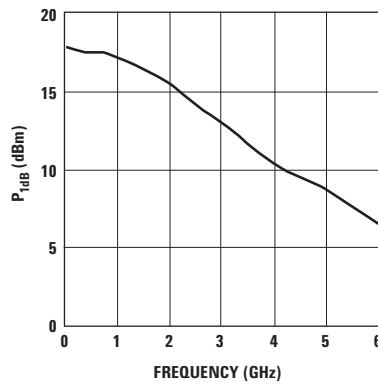

Figure 4. P_{1dB} vs. Frequency at $I_d = 60$ mA.

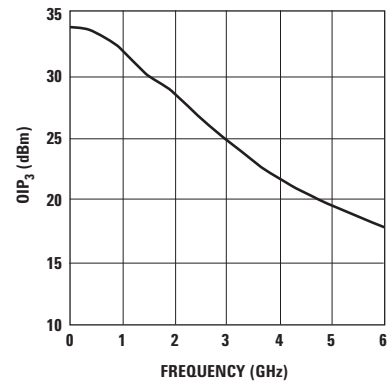

Figure 5. OIP_3 vs. Frequency at $I_d = 60$ mA.

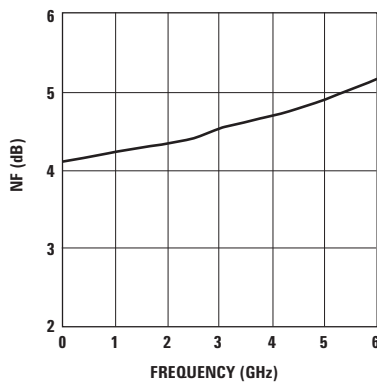

Figure 6. NF vs. Frequency at $I_d = 60$ mA.

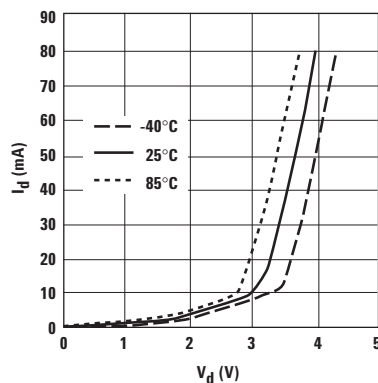

Figure 7. I_d vs. V_d and Temperature.

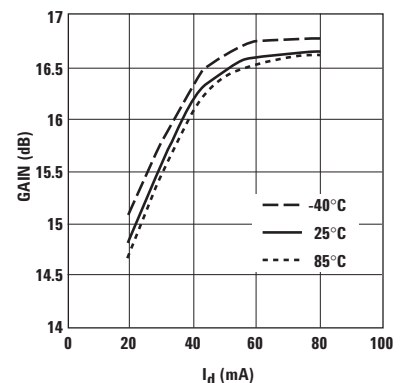

Figure 8. Gain vs. I_d and Temperature at 900 MHz.

ADA-4743 Typical Performance Curves (at 25°C, unless specified otherwise), continued

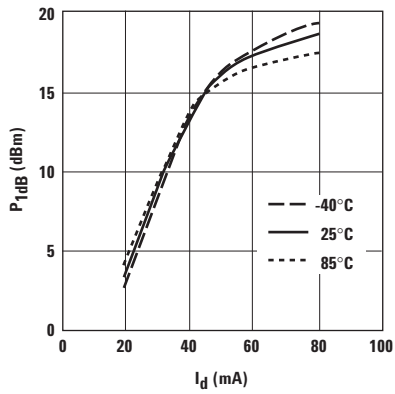

Figure 9. P_{1dB} vs. I_d and Temperature at 900 MHz.

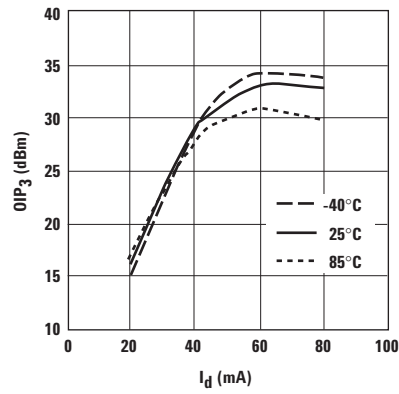

Figure 10. OIP_3 vs. I_d and Temperature at 900 MHz.

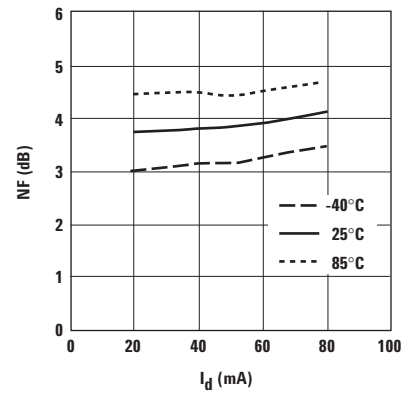

Figure 11. NF vs. I_d and Temperature at 900 MHz.

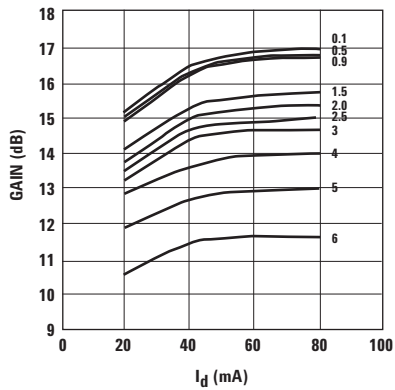

Figure 12. Gain vs. I_d and Frequency (GHz).

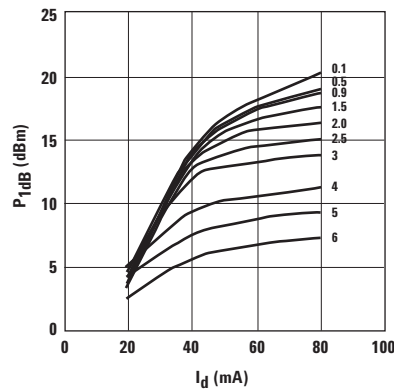

Figure 13. P_{1dB} vs. I_d and Frequency (GHz).

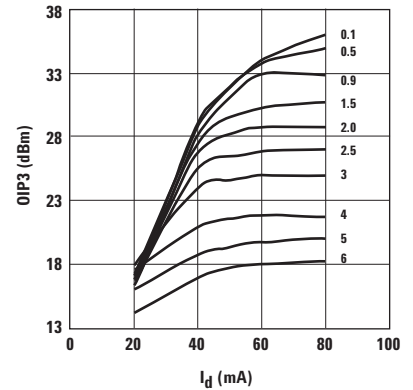

Figure 14. OIP_3 vs. I_d and Frequency (GHz).

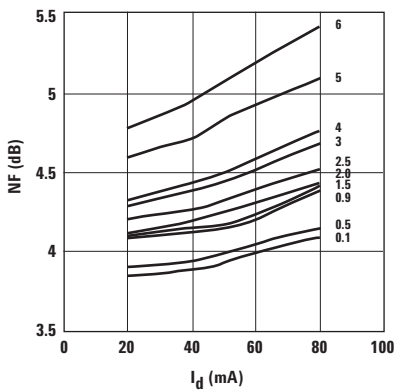

Figure 15. NF vs. I_d and Frequency (GHz).

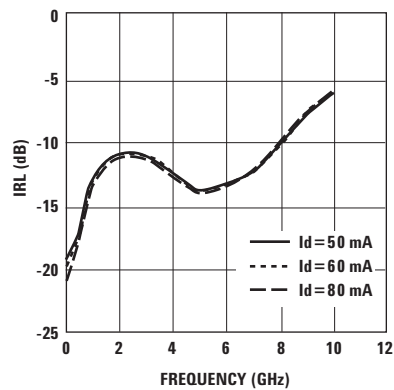

Figure 16. Input Return Loss vs. I_d and Frequency.

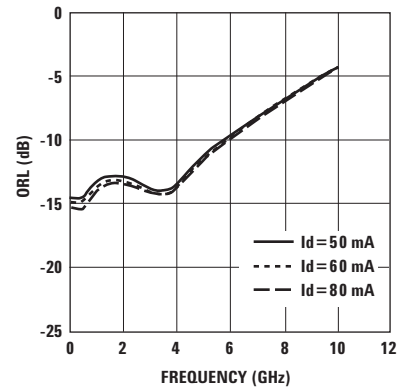

Figure 17. Output Return Loss vs. I_d and Frequency.

ADA-4743 Typical Scattering Parameters, $T_A = 25^\circ\text{C}$, $I_d = 50\text{ mA}$

Freq. GHz	S_{11}		dB	S_{21}		S_{12}		S_{22}		K
	Mag.	Ang.		Mag.	Ang.	Mag.	Ang.	Mag.	Ang.	
0.1	0.11	0.7	16.59	6.751	176.1	0.1	-0.8	0.192	-5.6	1.1
0.5	0.136	12.2	16.45	6.644	160.8	0.098	-3.9	0.191	-17.2	1.1
0.9	0.203	14.9	16.13	6.406	145.9	0.094	-6.2	0.214	-26.3	1.1
1.0	0.214	11.8	16.04	6.336	142.5	0.093	-6.4	0.218	-29.65	1.1
1.5	0.262	-4.1	15.57	6.002	125.7	0.09	-7	0.232	-46.8	1.1
1.9	0.278	-13.9	15.22	5.767	112.9	0.088	-6.8	0.232	-60.6	1.2
2.0	0.284	-16.6	15.14	5.718	109.8	0.088	-6.7	0.231	-64	1.2
2.5	0.289	-28.7	14.75	5.467	94.4	0.087	-5.7	0.221	-81.8	1.2
3.0	0.281	-40.4	14.38	5.239	79.4	0.089	-4.6	0.209	-102.3	1.2
3.5	0.265	-53.8	14.01	5.017	64.2	0.092	-3.6	0.204	-125.6	1.2
4.0	0.239	-70.5	13.63	4.804	49.3	0.098	-3.1	0.215	-149.2	1.2
4.5	0.218	-90.6	13.24	4.594	34.4	0.105	-3.4	0.244	-170.4	1.1
5.0	0.204	-114.3	12.74	4.334	19.5	0.114	-4.9	0.276	172.3	1.1
5.5	0.206	-140	12.24	4.093	5.1	0.125	-7.3	0.309	158.4	1.0
6.0	0.219	-163.7	11.67	3.833	-9.5	0.137	-11	0.338	145.1	1.0
6.5	0.225	172.6	11.13	3.603	-23.8	0.152	-15.8	0.364	130.2	0.9
7.0	0.237	147.8	10.52	3.359	-38.2	0.167	-22.1	0.393	113.5	0.9
7.5	0.263	121.8	9.82	3.096	-52.6	0.179	-29.4	0.427	96.2	0.9
8.0	0.307	97.6	8.99	2.814	-66.6	0.188	-37.2	0.462	79.1	0.9
8.5	0.345	78.9	7.97	2.504	-79.1	0.194	-44.4	0.501	65.4	0.9
9.0	0.4	63.8	7.08	2.259	-91	0.202	-50.8	0.541	54.3	0.9
9.5	0.45	50.6	6	1.995	-102.8	0.21	-57.9	0.583	44.3	0.9
10.0	0.496	40	5.05	1.79	-113.5	0.215	-65.1	0.62	35.7	0.9

Notes:

1. S-parameters are measured on a microstrip line made on 0.025 inch thick alumina carrier. The input reference plane is at the end of the input lead. The output reference plane is at the end of the output lead.

ADA-4743 Typical Scattering Parameters, $T_A = 25^\circ\text{C}$, $I_d = 60\text{ mA}$

Freq. GHz	S_{11}		dB	S_{21}		S_{12}		S_{22}		K
	Mag.	Ang.		Mag.	Ang.	Mag.	Ang.	Mag.	Ang.	
0.1	0.102	0.5	16.7	6.836	176.1	0.099	-0.8	0.183	-5.6	1.1
0.5	0.131	14.2	16.56	6.73	160.7	0.097	-3.8	0.182	-17	1.1
0.9	0.199	16.3	16.24	6.489	145.8	0.094	-6	0.207	-25.9	1.1
1.0	0.204	13.3	16.15	6.418	142.3	0.093	-6.3	0.212	-29	1.1
1.5	0.257	-3.2	15.68	6.08	125.5	0.089	-6.8	0.225	-46.4	1.1
1.9	0.275	-12.9	15.33	5.84	112.7	0.088	-6.6	0.226	-60.3	1.2
2.0	0.28	-15.8	15.25	5.786	109.6	0.087	-6.5	0.225	-63.7	1.2
2.5	0.287	-27.7	14.85	5.529	94.2	0.087	-5.5	0.216	-81.7	1.2
3.0	0.279	-39.9	14.48	5.296	79	0.089	-4.3	0.205	-102.4	1.2
3.5	0.261	-53.6	14.09	5.066	63.9	0.092	-3.3	0.2	-126	1.2
4.0	0.238	-70.2	13.71	4.846	49	0.097	-2.8	0.212	-149.7	1.2
4.5	0.217	-91.2	13.31	4.631	34.1	0.105	-3	0.243	-170.9	1.1
5.0	0.201	-115.4	12.8	4.363	19.1	0.114	-4.6	0.275	171.8	1.1
5.5	0.205	-141	12.3	4.121	4.6	0.125	-6.9	0.308	157.8	1.0
6.0	0.216	-164.8	11.72	3.853	-9.9	0.138	-10.7	0.338	144.6	1.0
6.5	0.223	171.4	11.17	3.617	-24.2	0.152	-15.5	0.365	129.7	0.9
7.0	0.238	146.1	10.55	3.369	-38.6	0.167	-21.9	0.394	113	0.9
7.5	0.264	120.4	9.83	3.102	-52.9	0.18	-29.3	0.429	95.7	0.9
8.0	0.309	96.1	8.99	2.816	-66.9	0.189	-37.1	0.464	78.7	0.9
8.5	0.347	78.1	7.97	2.502	-79.4	0.195	-44.4	0.503	65	0.9
9.0	0.405	63.3	7.07	2.258	-91.1	0.202	-50.7	0.543	53.9	0.9
9.5	0.449	49.6	5.99	1.992	-103.1	0.21	-57.8	0.585	43.9	0.9
10.0	0.499	39.5	5.06	1.79	-113.6	0.216	-65.1	0.622	35.4	0.9

Notes:

1. S-parameters are measured on a microstrip line made on 0.025 inch thick alumina carrier. The input reference plane is at the end of the input lead. The output reference plane is at the end of the output lead.

ADA-4743 Typical Scattering Parameters, $T_A = 25^\circ\text{C}$, $I_d = 80\text{ mA}$

Freq. GHz	S_{11}		dB	S_{21}		S_{12}		S_{22}		K
	Mag.	Ang.		Mag.	Ang.	Mag.	Ang.	Mag.	Ang.	
0.1	0.093	1.2	16.81	6.929	176.1	0.098	-0.7	0.172	-5.6	1.1
0.5	0.123	16.5	16.68	6.824	160.6	0.096	-3.7	0.172	-16.7	1.1
0.9	0.195	18.4	16.36	6.58	145.6	0.093	-5.7	0.197	-25.2	1.1
1.0	0.201	15	16.27	6.51	142	0.092	-6.1	0.203	-28.4	1.1
1.5	0.253	-1.9	15.8	6.164	125.1	0.089	-6.6	0.217	-45.9	1.1
1.9	0.271	-12.3	15.44	5.916	112.2	0.087	-6.3	0.218	-59.8	1.2
2.0	0.278	-15.2	15.36	5.863	109	0.087	-6.2	0.218	-63.3	1.2
2.5	0.286	-27.3	14.96	5.595	93.4	0.087	-5.1	0.21	-81.5	1.2
3.0	0.278	-40	14.57	5.353	78.2	0.088	-3.8	0.2	-102.5	1.2
3.5	0.261	-54	14.17	5.113	62.9	0.092	-2.8	0.196	-126.5	1.2
4.0	0.235	-71.8	13.77	4.882	47.9	0.098	-2.2	0.209	-150.5	1.2
4.5	0.214	-93.2	13.36	4.654	32.8	0.106	-2.5	0.241	-171.9	1.1
5.0	0.198	-118	12.81	4.371	17.8	0.115	-4.2	0.274	170.7	1.1
5.5	0.205	-144.6	12.29	4.116	3.2	0.126	-6.6	0.307	156.7	1.0
6.0	0.218	-169	11.67	3.835	-11.4	0.139	-10.5	0.337	143.4	1.0
6.5	0.228	167.1	11.09	3.584	-25.7	0.154	-15.5	0.364	128.5	0.9
7.0	0.244	142	10.45	3.329	-40	0.169	-22	0.393	111.7	0.9
7.5	0.272	117.4	9.69	3.053	-54.3	0.181	-29.5	0.427	94.4	0.9
8.0	0.32	94	8.84	2.767	-68.2	0.19	-37.3	0.462	77.5	0.9
8.5	0.358	75.8	7.81	2.457	-80.5	0.196	-44.5	0.5	64	0.9
9.0	0.413	62	6.9	2.213	-91.9	0.202	-50.9	0.54	53	0.9
9.5	0.46	48.2	5.78	1.946	-103.9	0.21	-58	0.582	43.2	0.9
10.0	0.507	38	4.83	1.744	-114.2	0.216	-65.1	0.619	34.8	0.9

Notes:

1. S-parameters are measured on a microstrip line made on 0.025 inch thick alumina carrier. The input reference plane is at the end of the input lead. The output reference plane is at the end of the output lead.

Ordering Information

Part Number	No. of Devices	Container
ADA-4743-TR1	3000	7" Reel
ADA-4743-TR2	10000	13" Reel
ADA-4743-BLK	100	antistatic bag
ADA-4743-TR1G	3000	7" Reel
ADA-4743-TR2G	10000	13" Reel
ADA-4743-BLKG	100	antistatic bag

Note: For lead-free option, the part number will have the character "G" at the end.

Package Dimensions Outline 43 SOT-343 (SC70 4-lead)

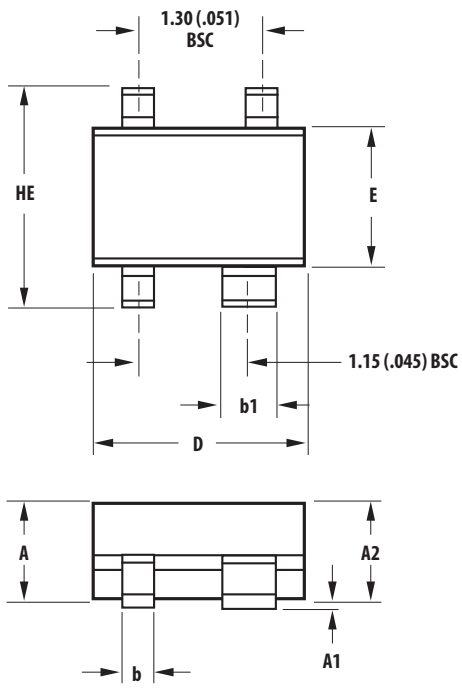

SYMBOL	DIMENSIONS (mm)	
	MIN.	MAX.
E	1.15	1.35
D	1.85	2.25
HE	1.80	2.40
A	0.80	1.10
A2	0.80	1.00
A1	0.00	0.10
b	0.15	0.40
b1	0.55	0.70
c	0.10	0.20
L	0.10	0.46

Recommended PCB Pad Layout for Avago's SC70 4L/SOT-343 Products

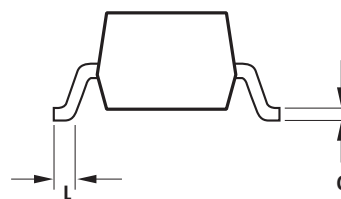
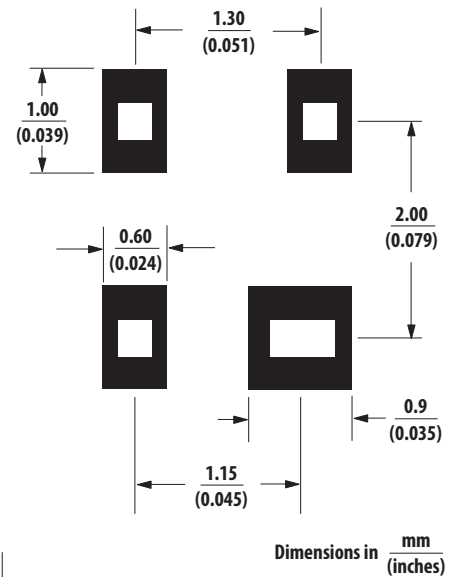

NOTES:

1. All dimensions are in mm.
2. Dimensions are inclusive of plating.
3. Dimensions are exclusive of mold flash & metal burr.
4. All specifications comply to EIAJ SC70.
5. Die is facing up for mold and facing down for trim/form, ie: reverse trim/form.
6. Package surface to be mirror finish.

Device Orientation

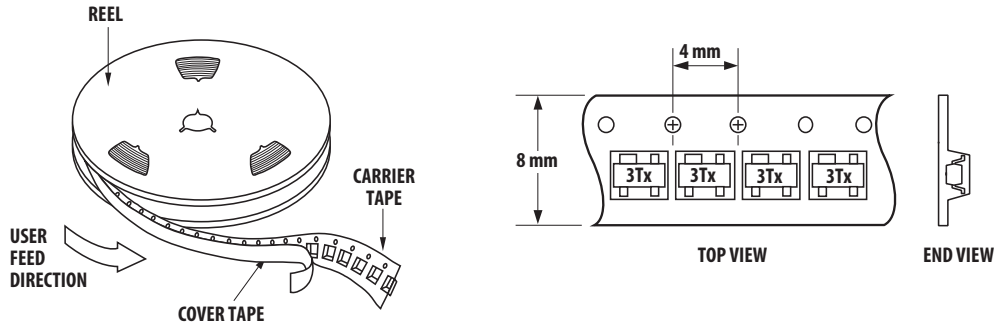

Tape Dimensions for Outline 4T

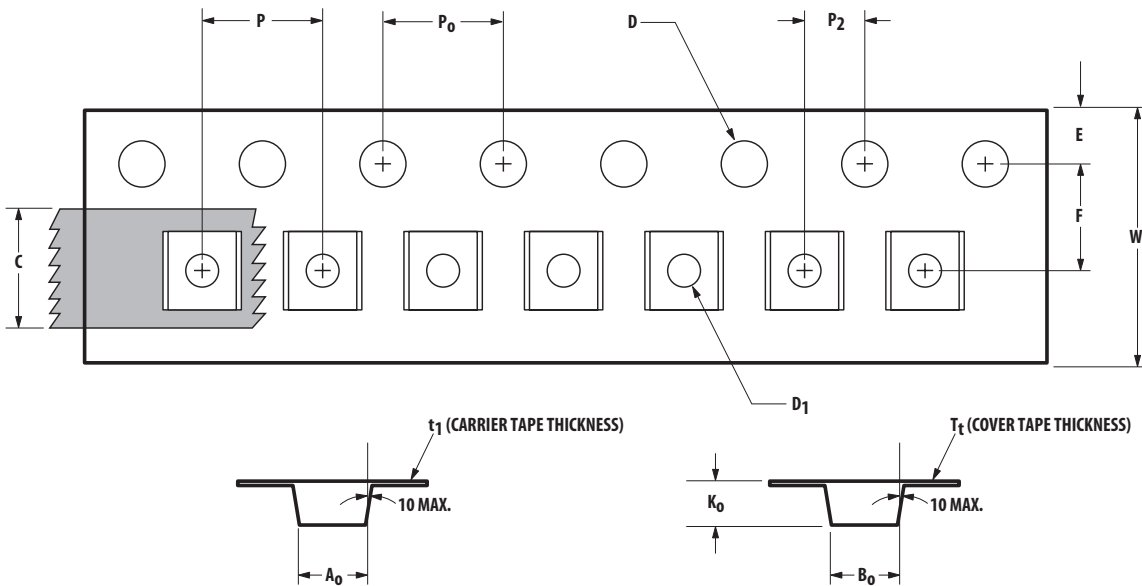

	DESCRIPTION	SYMBOL	SIZE (mm)	SIZE (INCHES)
CAVITY	LENGTH	A ₀	2.40 ± 0.10	0.094 ± 0.004
	WIDTH	B ₀	2.40 ± 0.10	0.094 ± 0.004
	DEPTH	K ₀	1.20 ± 0.10	0.047 ± 0.004
	PITCH	P	4.00 ± 0.10	0.157 ± 0.004
	BOTTOM HOLE DIAMETER	D ₁	1.00 ± 0.25	0.039 ± 0.010
PERFORATION	DIAMETER	D	1.55 ± 0.10	0.061 ± 0.002
	PITCH	P ₀	4.00 ± 0.10	0.157 ± 0.004
	POSITION	E	1.75 ± 0.10	0.069 ± 0.004
CARRIER TAPE	WIDTH	W	8.00 ± 0.30 - 0.10	0.315 ± 0.012
	THICKNESS	t ₁	0.254 ± 0.02	0.0100 ± 0.0008
COVER TAPE	WIDTH	C	5.40 ± 0.10	0.205 ± 0.004
	TAPE THICKNESS	T _t	0.062 ± 0.001	0.0025 ± 0.0004
DISTANCE	CAVITY TO PERFORATION (WIDTH DIRECTION)	F	3.50 ± 0.05	0.138 ± 0.002
	CAVITY TO PERFORATION (LENGTH DIRECTION)	P ₂	2.00 ± 0.05	0.079 ± 0.002

For product information and a complete list of distributors, please go to our web site: www.avagotech.com

Avago, Avago Technologies, and the A logo are trademarks of Avago Technologies in the United States and other countries. Data subject to change. Copyright © 2005-2012 Avago Technologies. All rights reserved. Obsoletes 5989-3754EN AV02-3594EN - June 8, 2012

AVAGO
TECHNOLOGIES

X-ON Electronics

Largest Supplier of Electrical and Electronic Components

Click to view similar products for [RF Amplifier](#) category:

Click to view products by [Broadcom](#) manufacturer:

Other Similar products are found below :

[A82-1](#) [BGA622H6820XTSA1](#) [BGA 728L7 E6327](#) [BGB719N7ESDE6327XTMA1](#) [HMC397-SX](#) [HMC405](#) [HMC561-SX](#) [HMC8120-SX](#)
[HMC8121-SX](#) [HMC-ALH382-SX](#) [HMC-ALH476-SX](#) [SE2433T-R](#) [SMA3101-TL-E](#) [SMA39](#) [A66-1](#) [A66-3](#) [A67-1](#) [A81-2](#) [LX5535LQ](#)
[LX5540LL](#) [MAAM02350](#) [HMC3653LP3BETR](#) [HMC549MS8GETR](#) [HMC-ALH435-SX](#) [SMA101](#) [SMA32](#) [SMA411](#) [SMA531](#)
[SST12LP19E-QX6E](#) [WPM0510A](#) [HMC5929LS6TR](#) [HMC5879LS7TR](#) [HMC1087F10](#) [HMC1086](#) [HMC1016](#) [SMA1212](#) [MAX2689EWS+T](#)
[MAAMSS0041TR](#) [MAAM37000-A1G](#) [LTC6430AIUF-15#PBF](#) [SMA70-2](#) [SMA4011](#) [A231](#) [HMC-AUH232](#) [LX5511LQ](#) [LX5511LQ-TR](#)
[HMC7441-SX](#) [HMC-ALH310](#) [XD1001-BD-000V](#) [A4011](#)