

# ALM-80110

## 0.25W Analog Variable Gain Amplifier

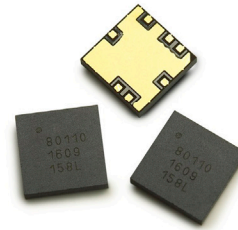

### Data Sheet



#### Description

Avago Technologies ALM-80110 is a 0.25W Analog Controlled Variable Gain Amplifier which operates from 0.4GHz to 1.6GHz. The device provides an exceptionally high OIP3 level of 40dBm, which is maintained over a wide attenuation range. The device features wide gain control range, low current, excellent input and output return loss.

The ALM-80110 is housed in a miniature 5.0X5.0X1.1 mm<sup>3</sup>, 10-lead multiple-chips-on-board (MCOB) module package. This part is suitable for the AGC/Temperature compensation circuits application in wireless infrastructure such as Cellular/PCS/W-CDMA/WLLand and new generation wireless technologies systems.

#### Pin connections and Package Marking

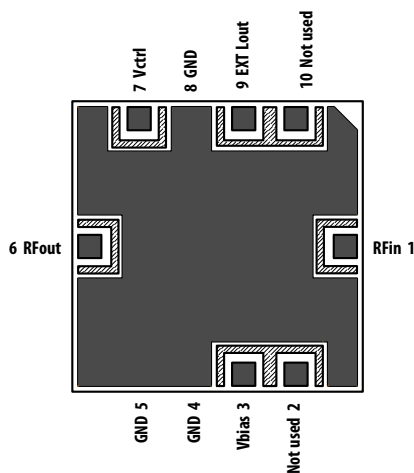
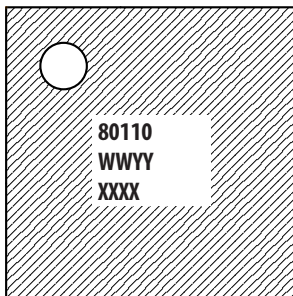

Note :  
 Top View : Package marking provides orientation and identification  
 "80110" = Device Code  
 "WWYY" = Workweek and Year Code  
 "XXXX" = Assembly Lot number

#### Features

- Halogen free
- Wide Gain Control Range
- High OIP3 across attenuation range

#### Specifications

At 0.9GHz,  $V_{dd} = 5V$ ,  $I_{total} = 110mA$  (typ),  $V_{bias} = 4V$ ,  $V_{ctrl} = 5V$  @ 25°C

- OIP3 = 40.5dBm
- Noise Figure = 4.8dB
- Gain = 13.5dB
- P1dB = 23.2dBm
- IRL = 17dB, ORL = 12dB
- Attenuation Range = 40dB

#### Application

- WLL, WLAN and other applications in the 400MHz to 1.6GHz range.
- Transmitter and Receiver Gain Control
- Temperature Compensation Circuitry



**Attention: Observe precautions for handling electrostatic sensitive devices.**  
 ESD Machine Model = 100 V  
 ESD Human Body Model = 650 V  
 Refer to Avago Application Note A004R: Electrostatic Discharge, Damage and Control.

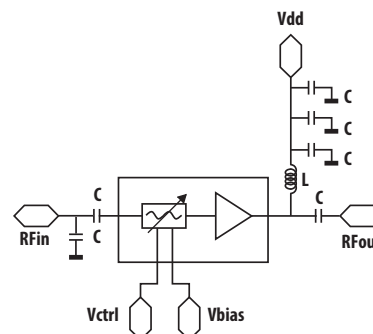

Figure 1. Simplified Schematic diagram

## ALM-80110 Absolute Maximum Rating (1)

$T_C = 25^\circ\text{C}$

Symbol	Parameter	Units	Absolute Maximum
$I_{d,max}$	Drain Current	mA	140
$V_{d,max}$	Drain Voltage, RF output to ground	V	5.5
$V_{ctrl,max}$	Control Voltage	V	7
$V_{bias,max}$	Biasing Voltage	V	15
$P_d$	Power Dissipation	mW	770
$P_{in}$	CW RF Input Power <sup>[4]</sup>	dBm	26
$T_j$	Junction Temperature	$^\circ\text{C}$	150
$T_{STG}$	Storage Temperature	$^\circ\text{C}$	-65 to 150

## Thermal Resistance (2,3)

( $V_d = 5.0\text{V}$ )  $\theta_{jc} = 77.2^\circ\text{C}/\text{W}$

Notes:

1. Operation of this device in excess of any of these limits may cause permanent damage
2. Derate  $12.95\text{mW}/^\circ\text{C}$  for  $T_L > 86^\circ\text{C}$
3. Thermal resistance measured using  $150^\circ\text{C}$  Infra-Red Microscopy Technique.
4. Max rating for  $P_{in}$  is under Maximum Attenuation mode i.e.  $V_{ctrl} = 1\text{V}$ .

## ALM-80110 Electrical Specification (1)

$T_C = 25^\circ\text{C}$ ,  $Z_o = 50\Omega$ ,  $V_{dd} = 5.0\text{V}$ ,  $V_{bias} = 4.0\text{V}$ ,  $V_{ctrl} = 5.0\text{V}$  unless noted

Symbol	Parameter and Test Condition	Frequency	Units	Min.	Typ.	Max.	stdev
$I_{total}$	Total Operating Current Range	N/A	mA	89	110	134	0.002
NF	Noise Figure at minimal Attenuation	0.45GHz 0.7GHz 0.9GHz	dB		5.5 4.7 4.8	5.4	0.090
Gain	Gain at minimal Attenuation	0.45GHz 0.7GHz 0.9GHz	dB	12	17 15 13.5	15	0.165
OIP3 <sup>(2)</sup>	Output Third Order Intercept Point	0.45GHz 0.7GHz 0.9GHz	dBm	36	40 40 40.5		0.717
P1dB	Output Power at 1dB Gain Compression	0.45GHz 0.7GHz 0.9GHz	dBm	22	23.5 23.3 23.2		0.068
IRL	Input Return Loss	0.45GHz 0.7GHz 0.9GHz	dB		12 20 17		NA
ORL	Output Return Loss	0.45GHz 0.7GHz 0.9GHz	dB		10 10.5 12		NA
ISO	Isolation	0.45GHz 0.7GHz 0.9GHz	dB		30.5 30.5 30.5		NA
$V_{bias}$	Attenuator Bias Voltage	N/A	V	2.7	4	5	NA
$V_{ctrl}$	Gain Variation Control Voltage	N/A	V	1	-	5	NA
$\Delta$ Gain	Gain Variation Range (from $V_{ctrl}=1\text{V}$ to $5\text{V}$ )	0.45GHz 0.7GHz 0.9GHz	dB		46 43 40		NA

Note :

1. Measurements obtained from a test circuit described in Figure 53.
2. OIP3 test condition:  $F_1 - F_2 = 10\text{MHz}$ , with input power of  $-10\text{dBm}$  per tone measured at worst case side band.
3. Standard deviation data are based on at least 1000 pieces samples size taken from 2 wafer lots. Future wafers allocated to this product may have nominal values anywhere between the upper and lower specification limits.

## ALM-80110 Product Consistency Distribution at 900MHz

$T_C = 25^\circ\text{C}$ ,  $V_{dd} = 5.0\text{V}$ ,  $V_{bias} = 4.0\text{V}$

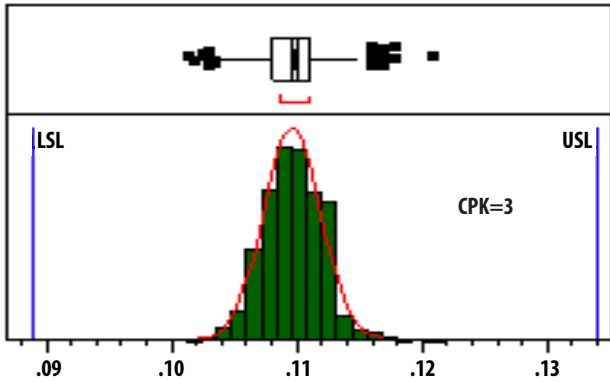

Figure 2. Itotal at 900MHz

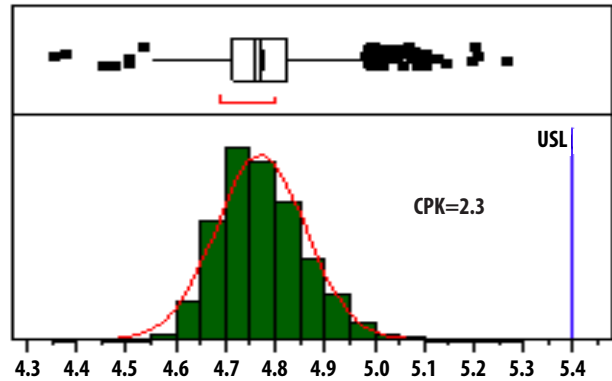

Figure 3. NF at 900MHz

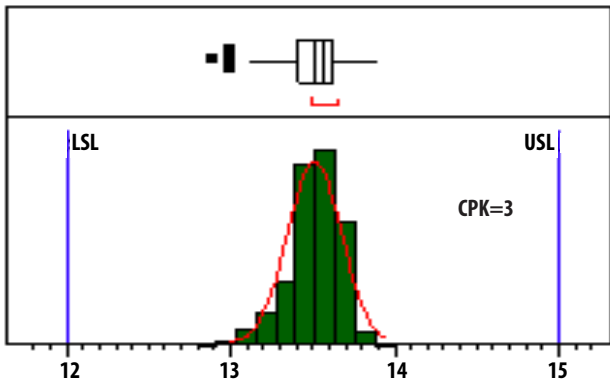

Figure 4. Gain at 900MHz

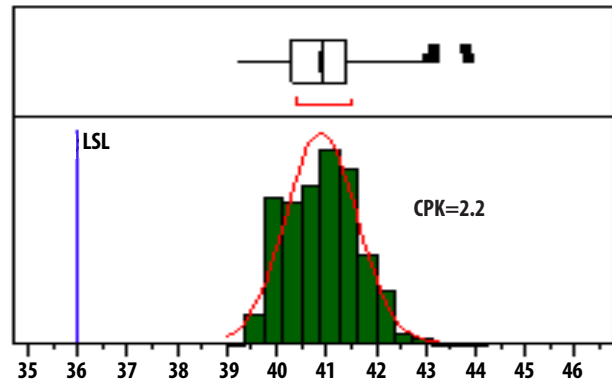

Figure 5. OIP3 at 900MHz

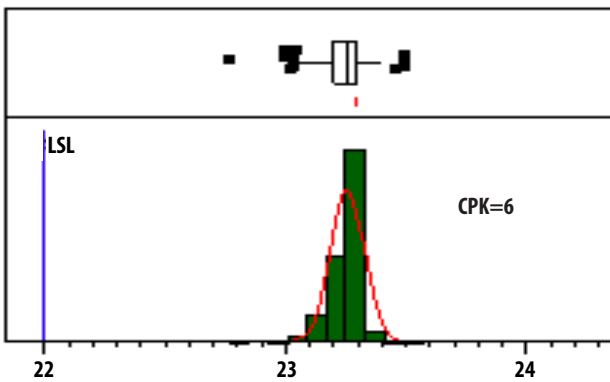

Figure 6. P1dB at 900MHz

### Note:

1. Statistics distribution determined from a sample size of 1000 parts taken from 2 different wafers.
2. Future wafers allocation to this product may have typical values anywhere between the minimum and maximum specification limits.
3. Measurements are made on production testboard, which represents a trade-off between optimal OIP3, P1dB and NF. Circuit losses have been de-embedded from actual measurements.

# ALM-80110 Application Circuit Data for 450MHz

$T_C = 25^\circ\text{C}$ ,  $V_{dd} = 5.0\text{V}$ ,  $V_{bias} = 4.0\text{V}$

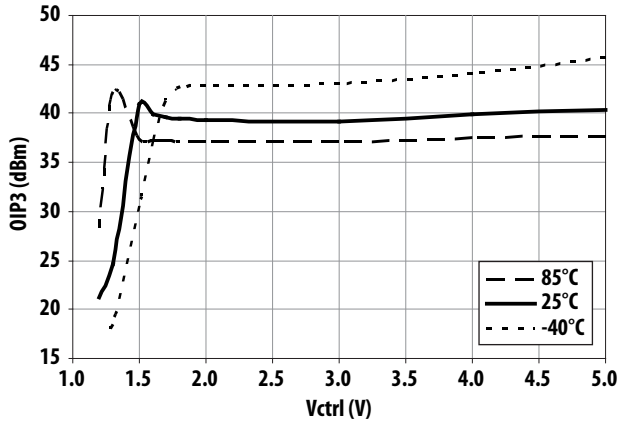

Figure 7. OIP3 vs Control Voltage and Temperature at 450MHz

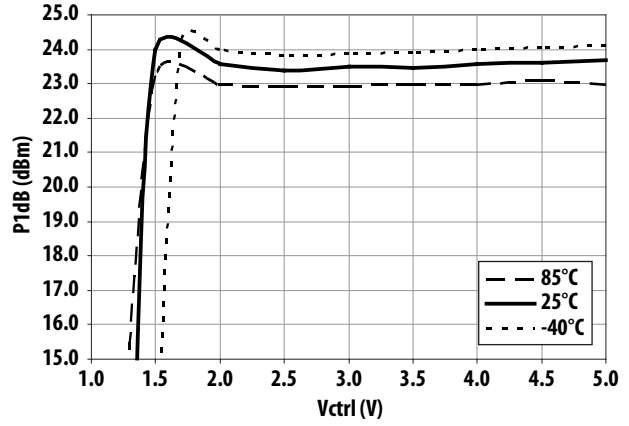

Figure 8. P1dB vs Control Voltage and Temperature at 450MHz

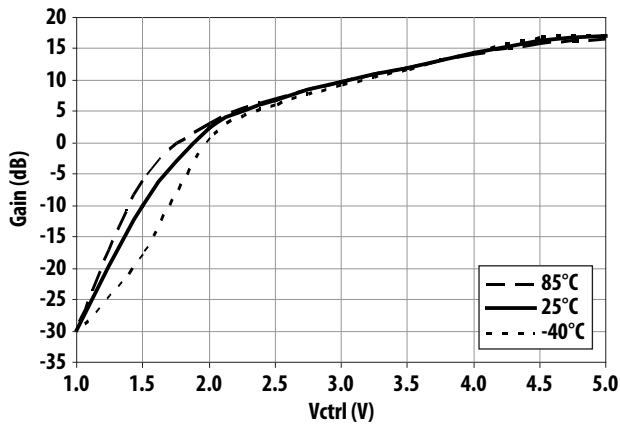

Figure 9. Gain vs Control Voltage and Temperature at 450MHz

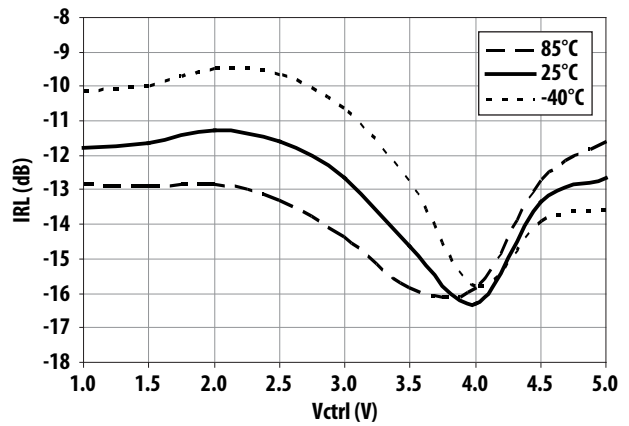

Figure 10. IRL vs Control Voltage and Temperature at 450MHz

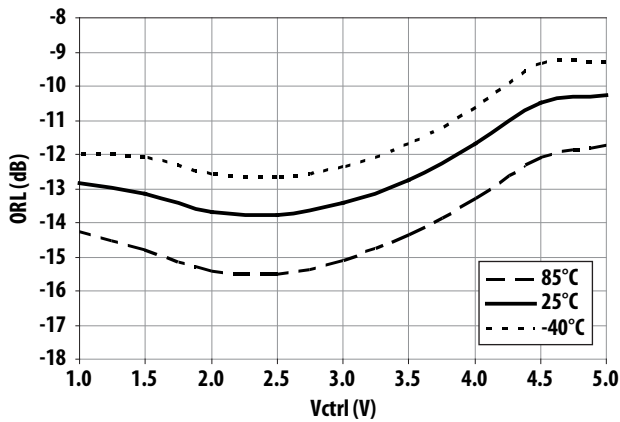

Figure 11. ORL vs Control Voltage and Temperature at 450MHz

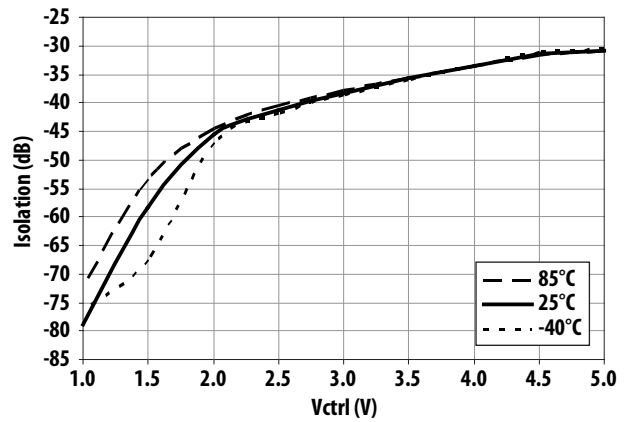

Figure 12. Isolation vs Control Voltage and Temperature at 450MHz

# ALM-80110 Application Circuit Data for 450MHz (cont'd)

$T_C = 25^\circ\text{C}$ ,  $V_{dd} = 5.0\text{V}$ ,  $V_{bias} = 4.0\text{V}$

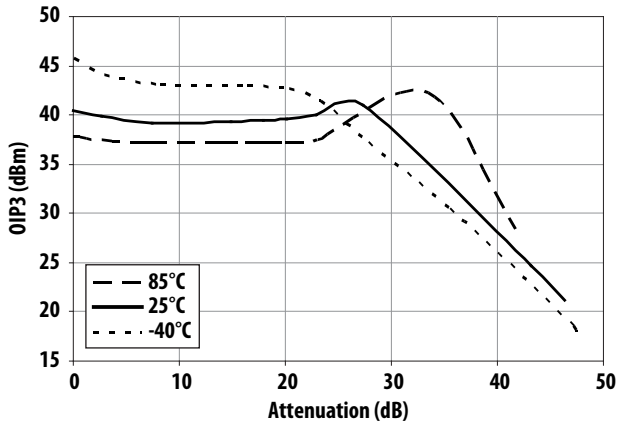

Figure 13. OIP3 vs Attenuation and Temperature at 450MHz

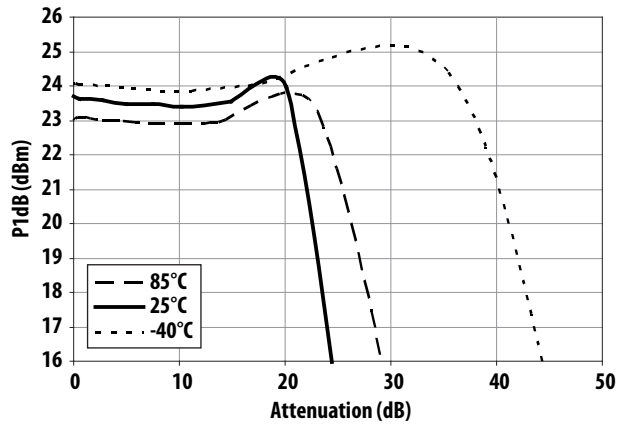

Figure 14. P1dB vs Attenuation and Temperature at 450MHz

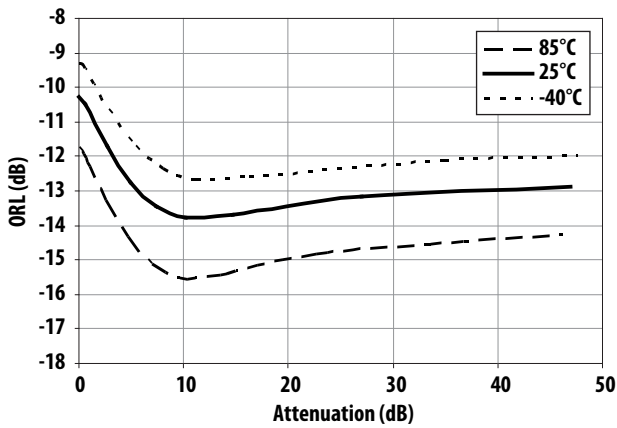

Figure 15. ORL vs Attenuation and Temperature at 450MHz

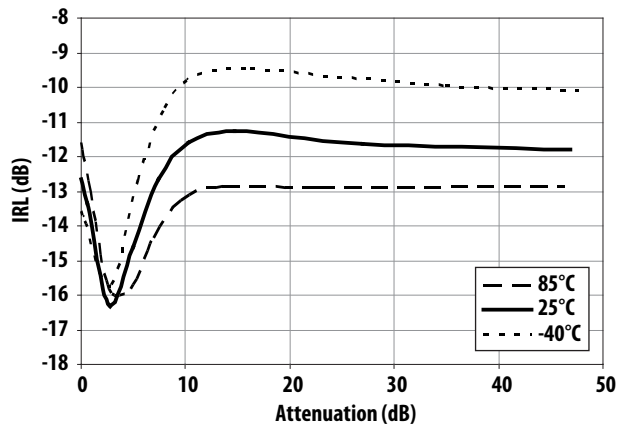

Figure 16. IRL vs Attenuation and Temperature at 450MHz

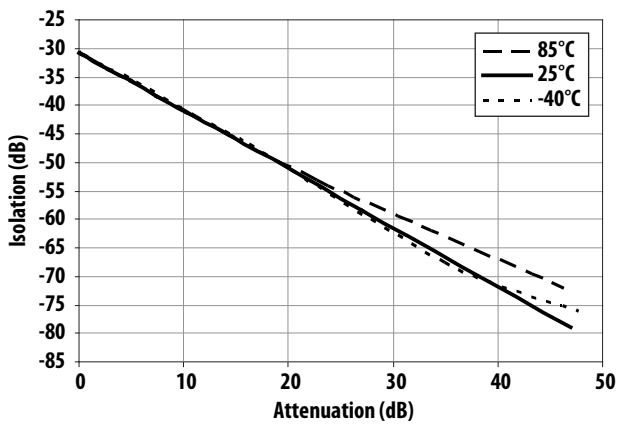

Figure 17. Isolation vs Attenuation and Temperature at 450MHz

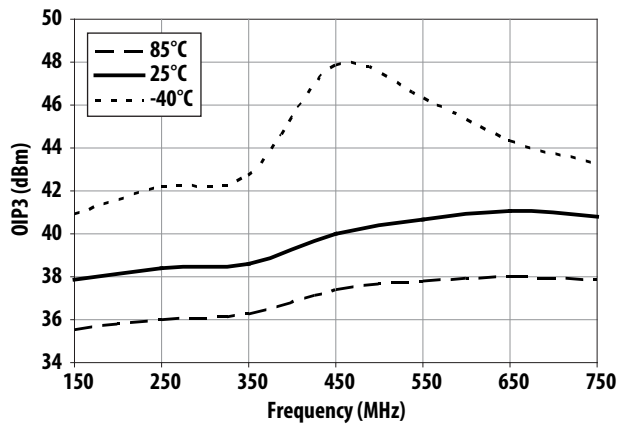

Figure 18. OIP3 vs Frequency and Temperature at  $V_{ctrl} = 5\text{V}$

# ALM-80110 Application Circuit Data for 450MHz (cont'd)

$T_C = 25^\circ\text{C}$ ,  $V_{dd} = 5.0\text{V}$ ,  $V_{bias} = 4.0\text{V}$

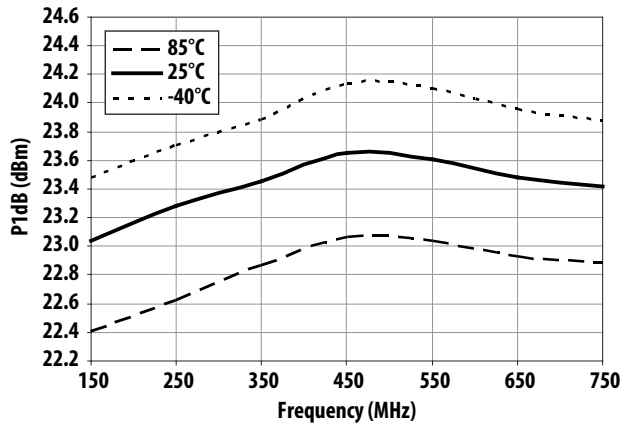

Figure 19. P1dB vs Frequency and Temperature at  $V_{ctrl} = 5\text{V}$

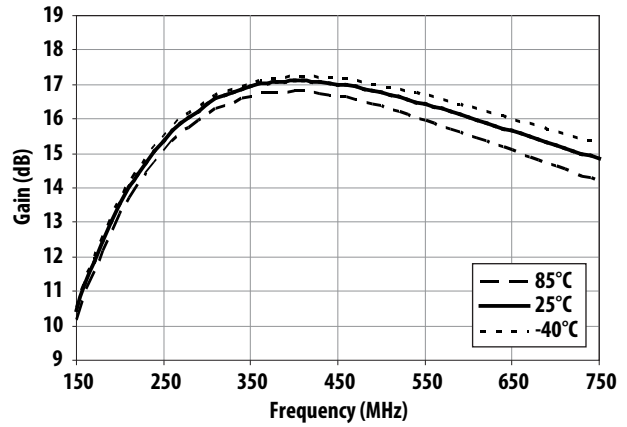

Figure 20. Gain vs Frequency and Temperature at  $V_{ctrl} = 5\text{V}$

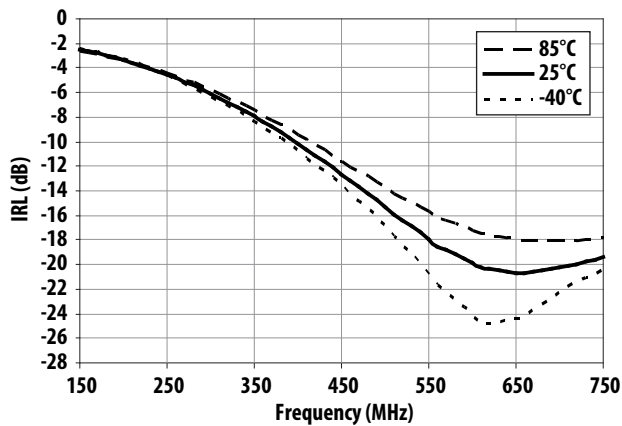

Figure 21. IRL vs Frequency and Temperature at  $V_{ctrl} = 5\text{V}$

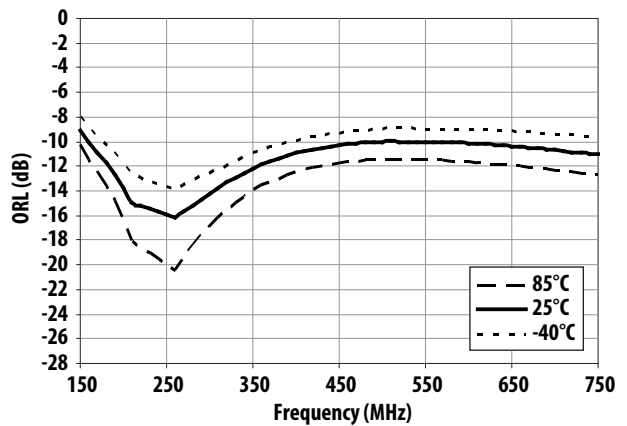

Figure 22. ORL vs Frequency and Temperature at  $V_{ctrl} = 5\text{V}$

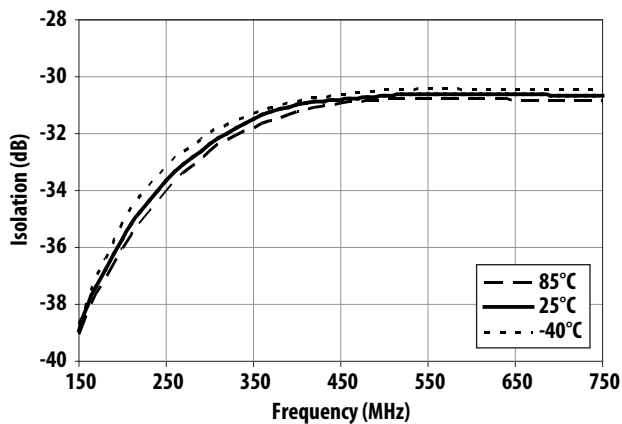

Figure 23. Isolation vs Frequency and Temperature at  $V_{ctrl} = 5\text{V}$

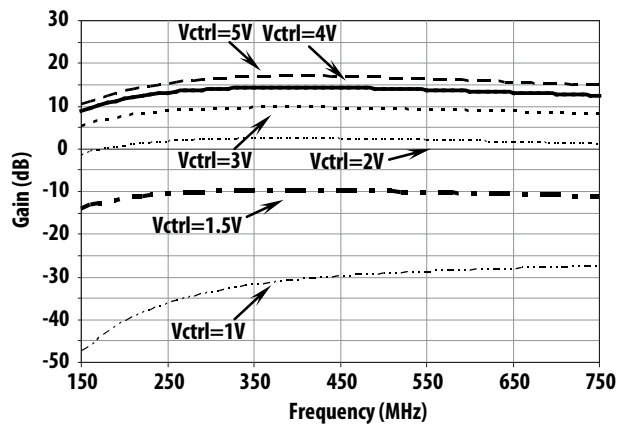

Figure 24. Gain vs Frequency and Control Voltage

## ALM-80110 Application Circuit Data for 450MHz (cont'd)

$T_C = 25^\circ\text{C}$ ,  $V_{dd} = 5.0\text{V}$ ,  $V_{bias} = 4.0\text{V}$

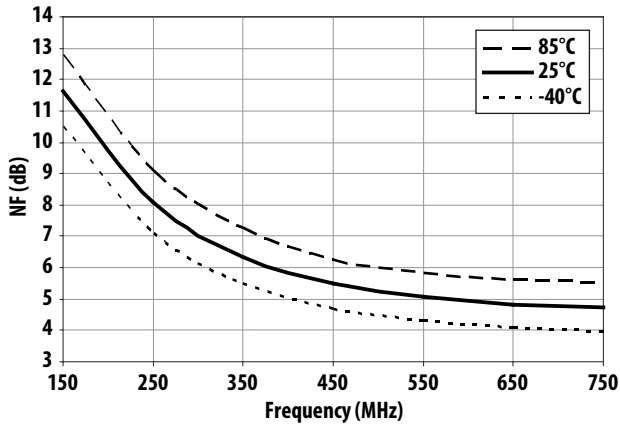

Figure 25. Noise Figure vs Frequency and Temperature at  $V_{ctrl} = 5\text{V}$

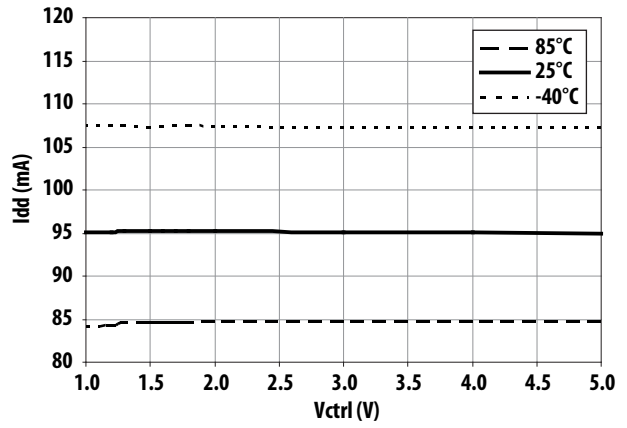

Figure 26. Current ( $I_{dd}$ ) vs Control Voltage and Temperature

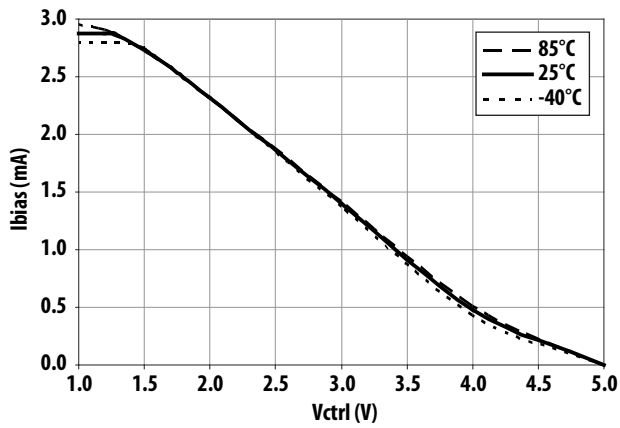

Figure 27. Current ( $I_{bias}$ ) vs Control Voltage and Temperature

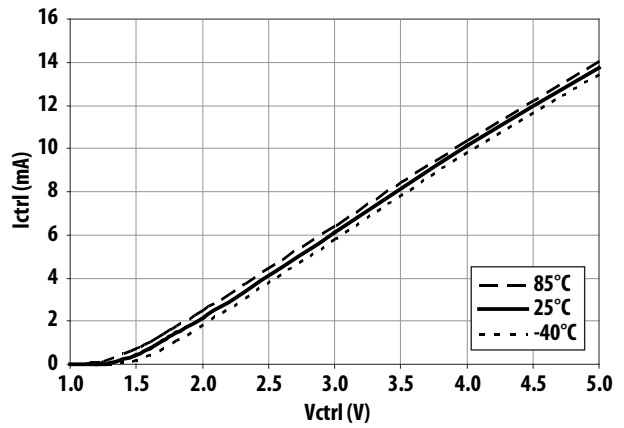

Figure 28. Current ( $I_{ctrl}$ ) vs Control Voltage and Temperature

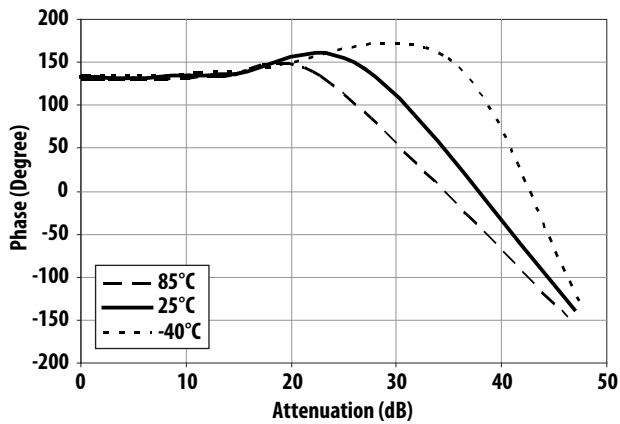

Figure 29. Phase vs Attenuation and Temperature at 450MHz (without external L1 as shown in Figure 54.)

# ALM-80110 Application Circuit Data for 900MHz

$T_C = 25^\circ\text{C}$ ,  $V_{dd} = 5.0\text{V}$ ,  $V_{bias} = 4.0\text{V}$

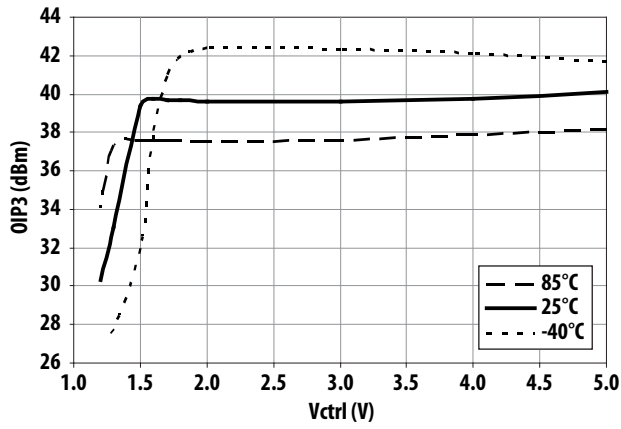

Figure 30. OIP3 vs Control Voltage and Temperature at 900MHz

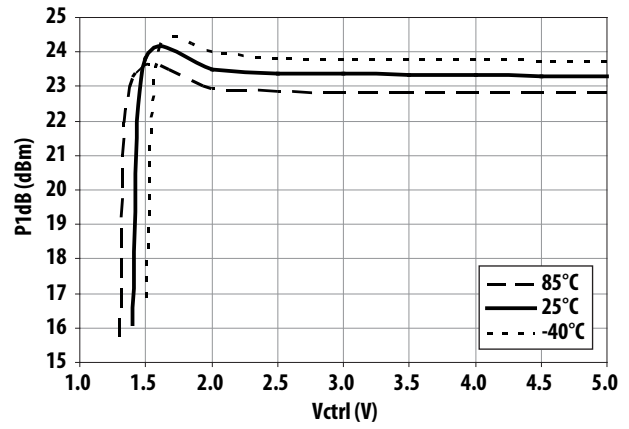

Figure 31. P1dB vs Control Voltage and Temperature at 900MHz

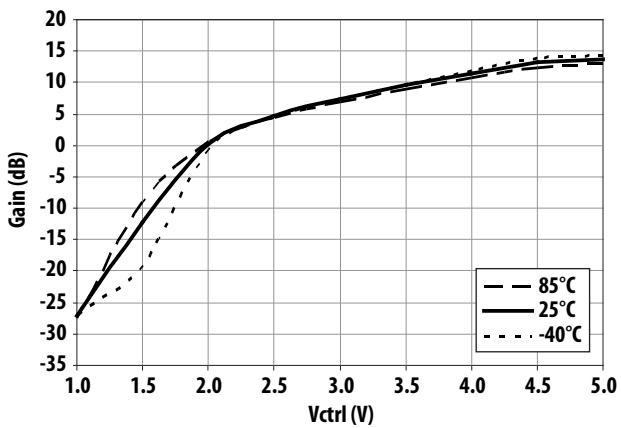

Figure 32. Gain vs Control Voltage and Temperature at 900MHz

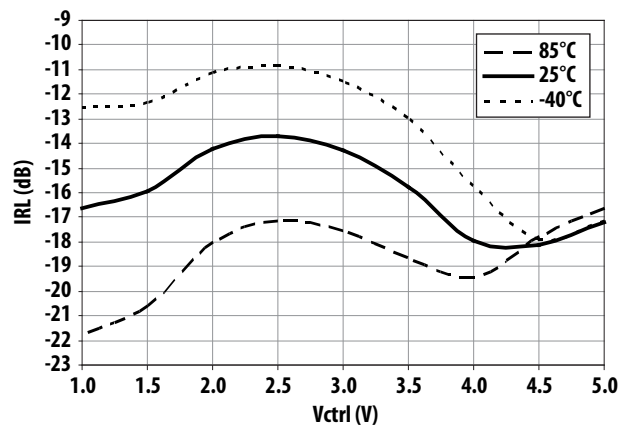

Figure 33. IRL vs Control Voltage and Temperature at 900MHz

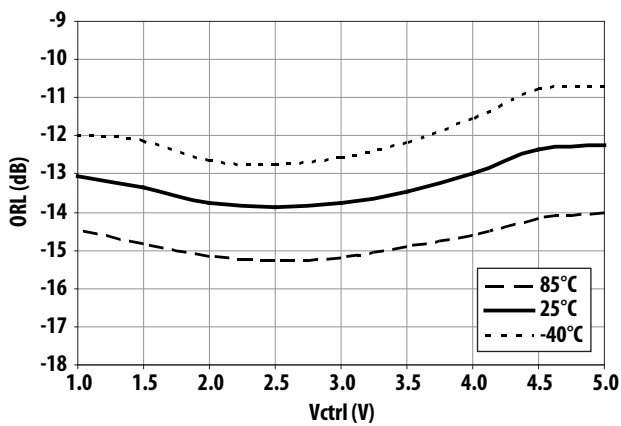

Figure 34. ORL vs Control Voltage and Temperature at 900MHz

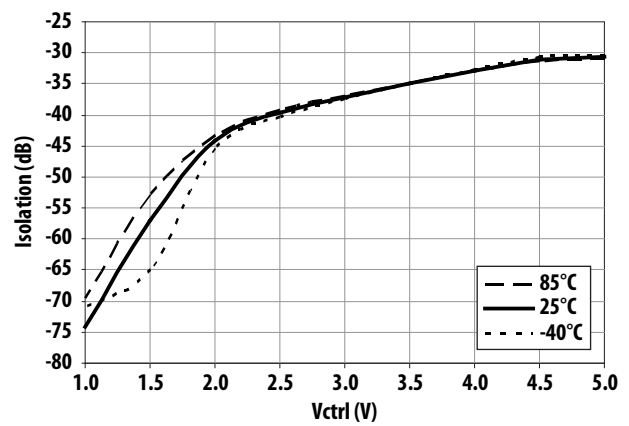

Figure 35. Isolation vs Control Voltage and Temperature at 900MHz



# ALM-80110 Application Circuit Data for 900MHz (cont'd)

$T_C = 25^\circ\text{C}$ ,  $V_{dd} = 5.0\text{V}$ ,  $V_{bias} = 4.0\text{V}$

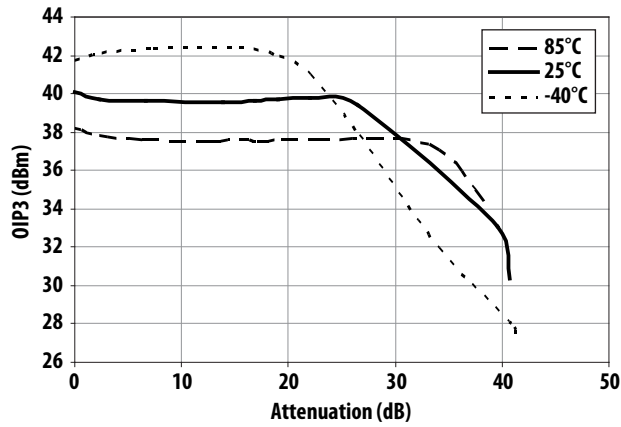

Figure 36. OIP3 vs Attenuation and Temperature at 900MHz

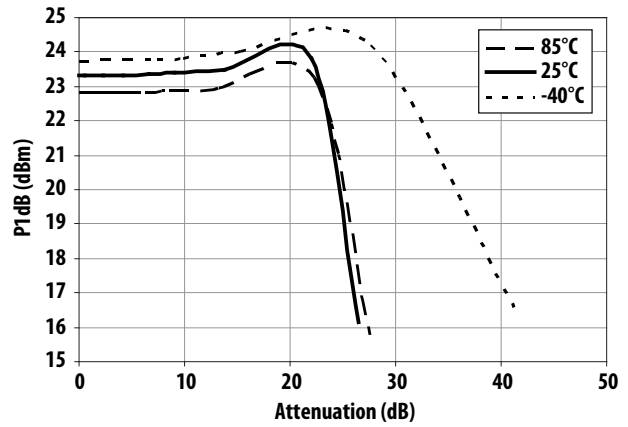

Figure 37. P1dB vs Attenuation and Temperature at 900MHz

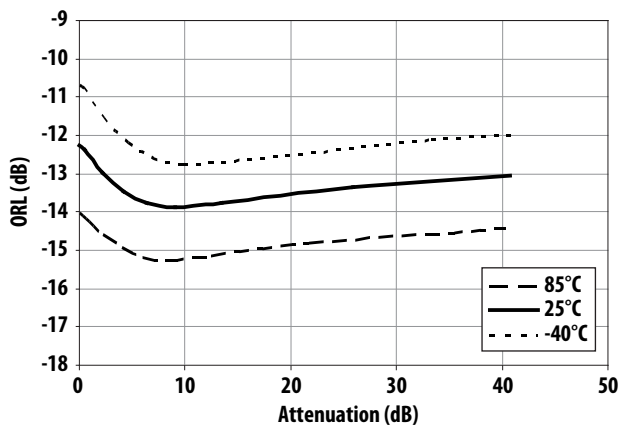

Figure 38. ORL vs Attenuation and Temperature at 900MHz

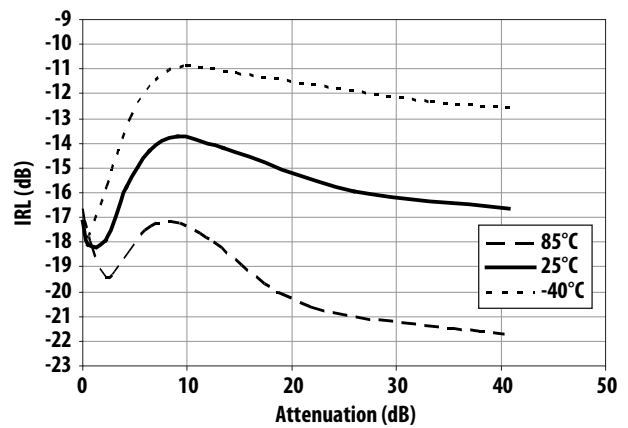

Figure 39. IRL vs Attenuation and Temperature at 900MHz

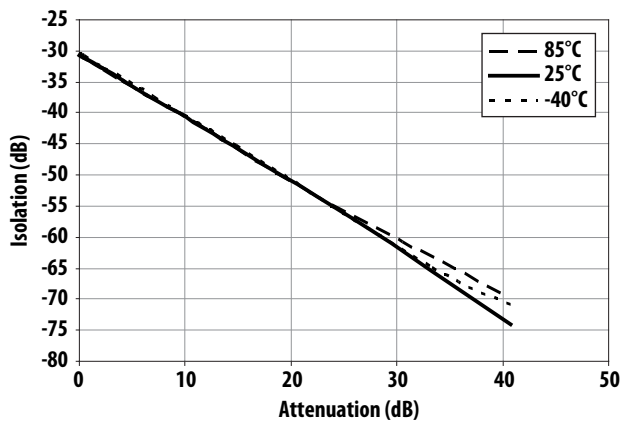

Figure 40. Isolation vs Attenuation and Temperature at 900MHz

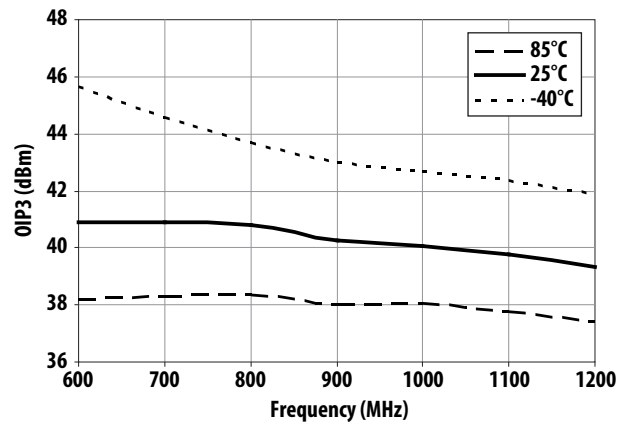

Figure 41. OIP3 vs Frequency and Temperature at  $V_{ctrl} = 5\text{V}$

# ALM-80110 Application Circuit Data for 900MHz (cont'd)

$T_C = 25^\circ\text{C}$ ,  $V_{dd} = 5.0\text{V}$ ,  $V_{bias} = 4.0\text{V}$

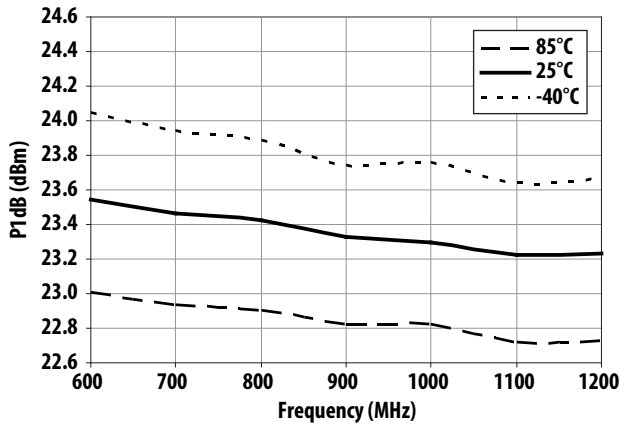

Figure 42. P1dB vs Frequency and Temperature at  $V_{ctrl} = 5\text{V}$

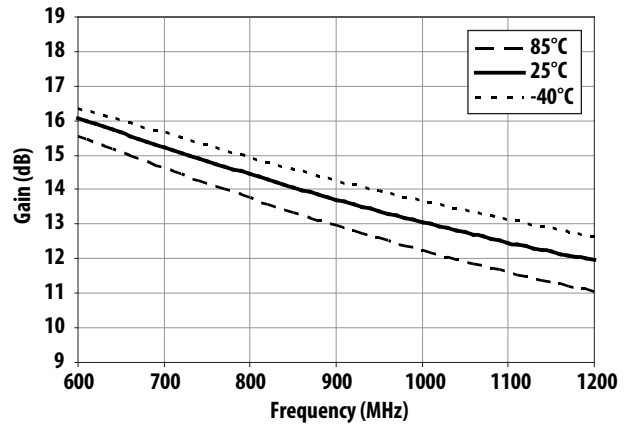

Figure 43. Gain vs Frequency and Temperature at  $V_{ctrl} = 5\text{V}$

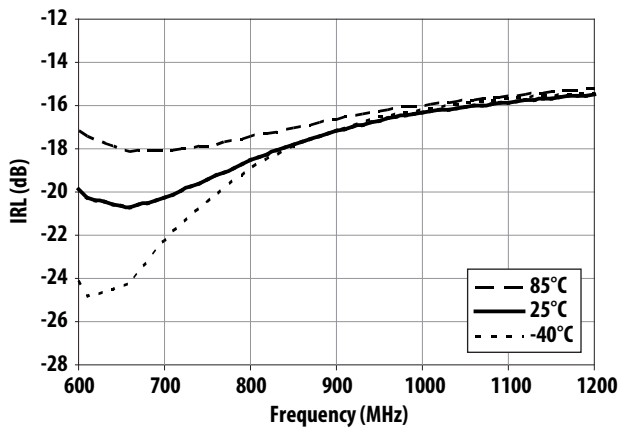

Figure 44. IRL vs Frequency and Temperature at  $V_{ctrl} = 5\text{V}$

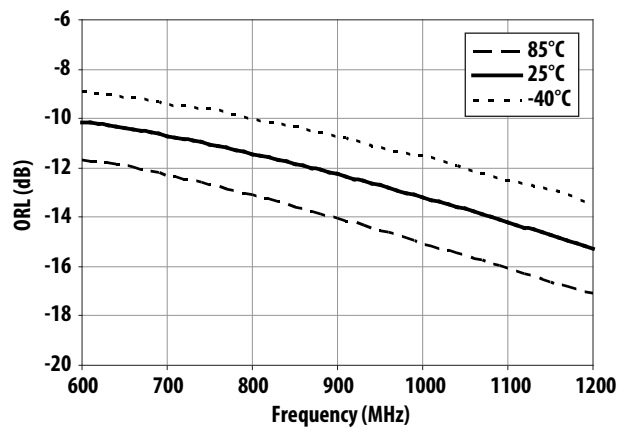

Figure 45. ORL vs Frequency and Temperature at  $V_{ctrl} = 5\text{V}$

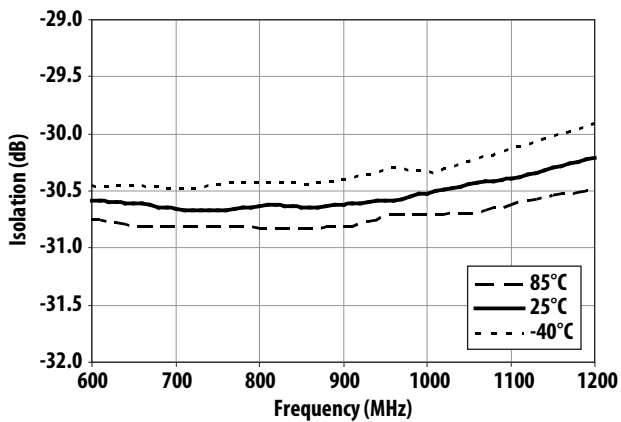

Figure 46. Isolation vs Frequency and Temperature at  $V_{ctrl} = 5\text{V}$

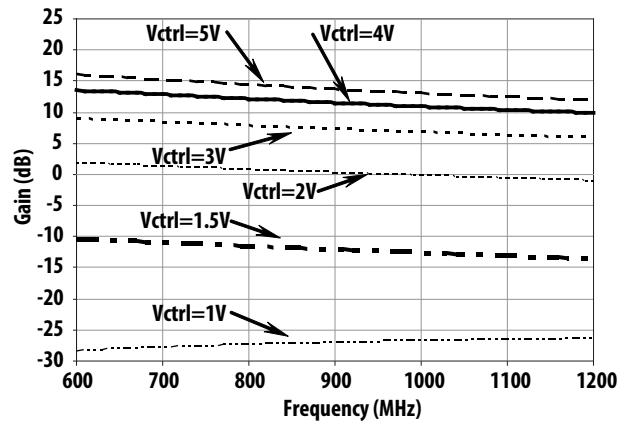

Figure 47. Gain vs Frequency and Control Voltage

# ALM-80110 Application Circuit Data for 900MHz (cont'd)

$T_C = 25^\circ\text{C}$ ,  $V_{dd} = 5.0\text{V}$ ,  $V_{bias} = 4.0\text{V}$

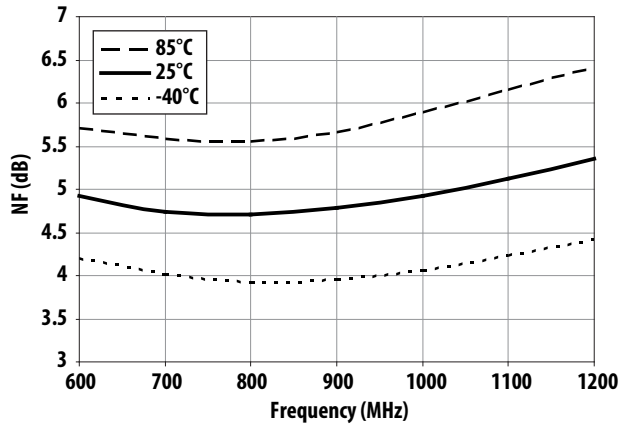

Figure 48. Noise Figure vs Frequency and Temperature at  $V_{ctrl} = 5\text{V}$

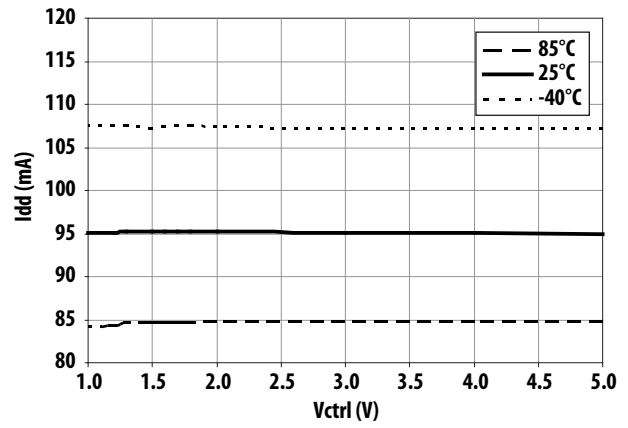

Figure 49. Current ( $I_{dd}$ ) vs Control Voltage and Temperature

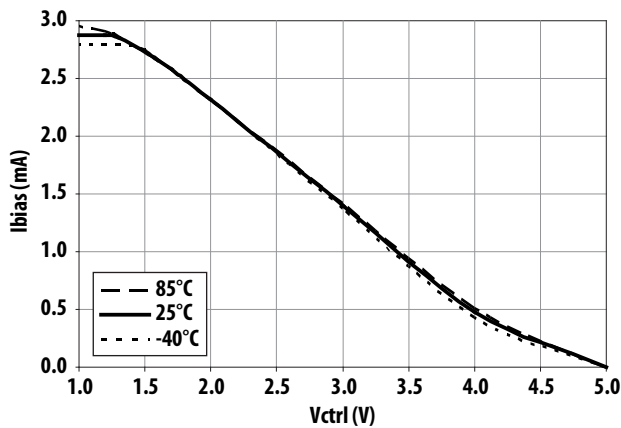

Figure 50. Current ( $I_{bias}$ ) vs Control Voltage and Temperature

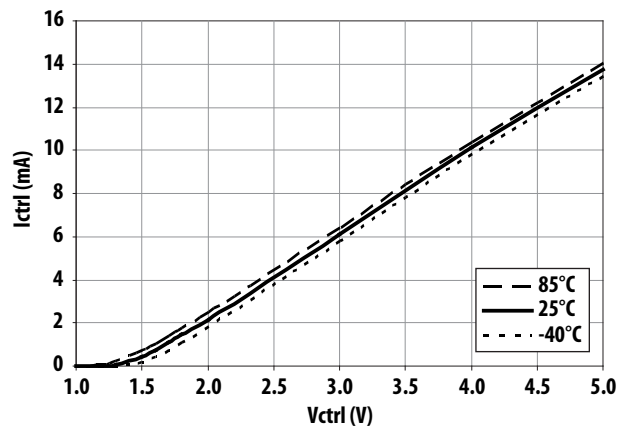

Figure 51. Current ( $I_{ctrl}$ ) vs Control Voltage and Temperature

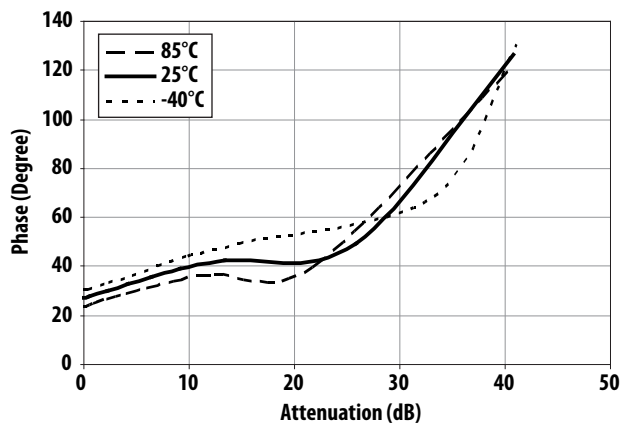

Figure 52. Phase vs Attenuation and Temperature at 900MHz (without external L1 as shown in Figure 54.)

## Application Circuit Description and Layout

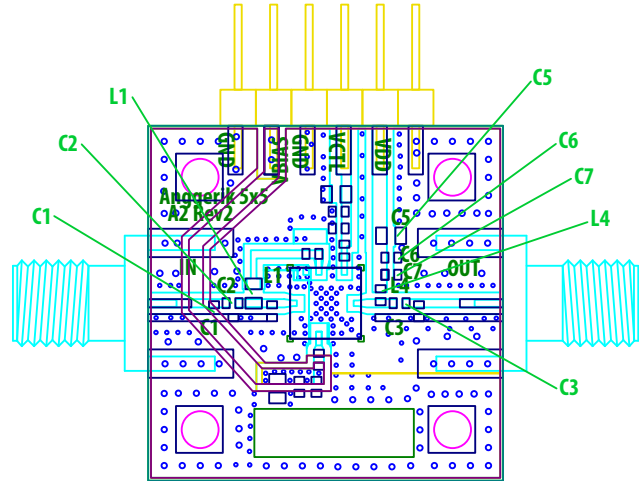
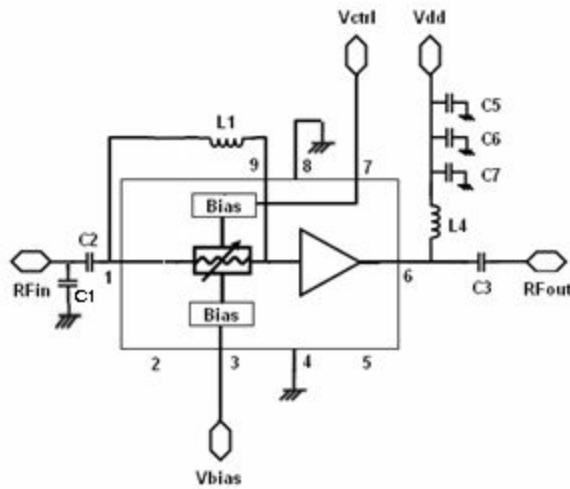

Figure 53. Demoboard schematic and layout

## Bill of Materials

Circuit Symbol	Size	Description	
		For 0.45GHz and 0.9GHz	
C1	0402	0.5pF	Murata
C2	0402	2.2nF	Murata
C3	0402	100pF	Murata
C5	0603	2.2uF	Murata
C6	0402	0.1uF	Murata
C7	0402	10pF	Murata
L1	0402	NA	
L4	0402	100nH	Toko

Note: NA – not being used on Demoboard

ALM-80110 is a input fully matched and output pre-matched product. The product requires 3 biasing points i.e. Vdd (to bias up the PA), Vbias and Vctrl (for controlling the attenuator circuitry). The Vdd is connected to the output pin thru a RF choke, L4 (which isolates the inband signal from the DC supply). The bypass capacitor (C5, C6 and C7) helps to eliminate out of band low frequency signals. DC blocking capacitors (C2 and C3) are required for its input and output, to isolate the supply voltage from succeeding circuits. To improve input return loss, C1 is being use for external tuning.

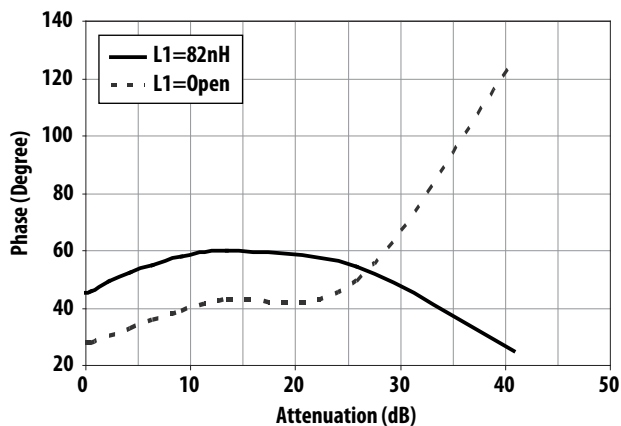

Figure 54. Phase vs Attenuation with and without External L1 at 900MHz

The external Inductor (L1), helps to stabilize the attenuator performance (by gain flatness and change of phase) for the frequency of interest as well as improving its dynamic range.

ALM-80110's gain is adjusted by supplying a voltage thru Vctrl. For absolute dynamic range, Vctrl can operate from 0.8 to 5V, but for best linearity, Vctrl above 1V is recommended.

## ALM-80110 Typical Scatter Parameters

$T_c = 25^\circ\text{C}$ ,  $V_{dd} = 5.0\text{V}$ ,  $V_{ctrl} = 5\text{V}$ ,  $V_{bias} = 4.0\text{V}$ ,  $Z_o = 50\Omega$

Freq	S11			S21			S12			S22		
GHz	Mag.	Ang.	dB	Mag.	Ang.	dB	Mag.	Ang.	dB	Mag.	Ang.	dB
0.1	0.8	151.0	-1.9	2.0	-68.8	5.9	0.0	131.5	-43.6	0.4	128.1	-8.5
0.2	0.7	124.0	-3.1	4.9	-118.0	13.7	0.0	92.5	-35.6	0.1	146.1	-20.5
0.3	0.5	95.3	-5.5	6.7	-155.3	16.5	0.0	63.7	-32.3	0.2	-157.2	-14.5
0.4	0.3	67.6	-9.2	7.3	174.5	17.2	0.0	42.6	-30.9	0.3	-167.1	-11.1
0.5	0.2	37.7	-14.1	7.0	150.8	17.0	0.0	27.2	-30.5	0.3	-178.2	-10.4
0.6	0.1	-3.2	-19.4	6.5	132.3	16.3	0.0	16.2	-30.3	0.3	173.6	-10.5
0.7	0.1	-57.9	-21.4	5.9	117.3	15.5	0.0	8.1	-30.4	0.3	167.6	-11.0
0.8	0.1	-94.0	-19.7	5.4	104.9	14.7	0.0	1.9	-30.3	0.3	163.4	-11.7
0.9	0.1	-112.5	-18.2	5.0	94.0	14.0	0.0	-3.2	-30.3	0.2	160.4	-12.5
1.0	0.1	-121.7	-17.2	4.6	84.5	13.3	0.0	-7.7	-30.2	0.2	157.6	-13.4
1.1	0.1	-126.6	-16.6	4.3	75.7	12.7	0.0	-12.2	-30.0	0.2	154.3	-14.5
1.2	0.2	-131.6	-16.5	4.1	67.4	12.2	0.0	-16.2	-29.9	0.2	153.5	-15.4
1.3	0.1	-135.0	-16.5	3.9	59.4	11.8	0.0	-20.4	-29.6	0.2	153.4	-16.4
1.4	0.1	-136.9	-16.6	3.7	51.7	11.4	0.0	-24.5	-29.4	0.1	154.2	-17.5
1.5	0.1	-137.6	-16.7	3.6	44.2	11.0	0.0	-28.7	-29.1	0.1	156.9	-18.7
1.6	0.1	-136.7	-16.9	3.4	36.7	10.7	0.0	-33.0	-28.8	0.1	161.5	-19.9
1.7	0.1	-135.4	-16.9	3.3	29.2	10.4	0.0	-37.7	-28.5	0.1	169.3	-21.0
1.8	0.1	-133.3	-16.7	3.2	21.7	10.2	0.0	-42.5	-28.2	0.1	-178.8	-21.8
1.9	0.2	-131.0	-16.4	3.2	14.0	10.0	0.0	-47.5	-27.9	0.1	-164.6	-21.9
2.0	0.2	-129.3	-15.9	3.1	6.2	9.8	0.0	-52.9	-27.6	0.1	-151.2	-21.0
2.1	0.2	-128.2	-15.2	3.0	-1.9	9.6	0.0	-58.6	-27.3	0.1	-141.4	-19.5
2.2	0.2	-128.2	-14.4	3.0	-10.1	9.5	0.0	-65.0	-27.0	0.1	-135.9	-17.7
2.3	0.2	-129.8	-13.5	2.9	-18.5	9.3	0.0	-71.3	-26.8	0.2	-134.1	-15.9
2.4	0.2	-132.4	-12.7	2.8	-27.2	9.1	0.0	-77.9	-26.6	0.2	-134.4	-14.4
2.5	0.3	-136.0	-11.9	2.8	-36.1	8.9	0.0	-85.2	-26.4	0.2	-136.1	-13.0
2.6	0.3	-140.5	-11.1	2.7	-45.2	8.6	0.0	-92.5	-26.3	0.3	-139.3	-11.7
2.7	0.3	-145.7	-10.5	2.6	-54.5	8.3	0.0	-100.0	-26.2	0.3	-143.1	-10.6
2.8	0.3	-151.1	-10.0	2.5	-63.7	8.0	0.0	-107.8	-26.2	0.3	-147.4	-9.6
2.9	0.3	-156.8	-9.7	2.4	-73.0	7.6	0.0	-115.6	-26.3	0.4	-152.0	-8.8
3.0	0.3	-162.5	-9.4	2.3	-82.2	7.1	0.0	-123.5	-26.4	0.4	-156.7	-8.1
3.5	0.3	173.8	-10.6	1.7	-125.7	4.4	0.0	-161.4	-27.9	0.5	-177.1	-6.1
4.0	0.2	-172.0	-16.2	1.2	-165.7	1.4	0.0	162.5	-30.1	0.5	170.4	-5.6
5.0	0.5	-123.0	-5.3	0.5	114.0	-5.3	0.0	80.7	-36.5	0.5	161.4	-6.4
6.0	0.8	-147.4	-1.9	0.2	90.6	-13.5	0.0	9.5	-45.2	0.5	158.1	-5.9
7.0	0.7	-176.3	-2.8	0.1	-12.0	-22.8	0.0	-128.9	-45.5	0.5	129.6	-5.7
8.0	0.5	177.9	-5.9	0.0	-140.0	-30.3	0.0	170.4	-38.1	0.6	100.5	-4.8
9.0	0.7	175.9	-2.9	0.0	35.3	-37.7	0.0	70.0	-43.7	0.6	92.4	-3.8
10.0	0.9	153.8	-0.6	0.0	-20.0	-53.1	0.0	39.1	-66.8	0.6	91.5	-3.9
11.0	0.8	148.6	-1.6	0.0	-125.1	-59.4	0.0	156.5	-51.8	0.6	82.0	-5.0
12.0	0.8	138.3	-2.0	0.0	39.9	-67.3	0.0	115.5	-56.7	0.5	52.9	-5.9
13.0	0.7	112.0	-2.9	0.0	81.5	-60.5	0.0	96.7	-52.9	0.6	23.4	-4.8
14.0	0.7	91.4	-3.3	0.0	47.9	-55.4	0.0	55.3	-51.5	0.6	11.9	-4.0
15.0	0.6	83.0	-4.0	0.0	-17.1	-52.2	0.0	-11.3	-50.4	0.6	7.9	-4.2
16.0	0.5	76.2	-6.0	0.0	-57.9	-58.1	0.0	-51.3	-55.0	0.6	-1.1	-4.9
17.0	0.3	60.5	-9.7	0.0	-26.8	-59.1	0.0	-50.3	-58.5	0.5	-19.0	-5.2
18.0	0.1	39.6	-21.9	0.0	-40.9	-53.3	0.0	-44.5	-55.4	0.6	-37.4	-4.9
19.0	0.3	105.9	-11.0	0.0	-64.2	-52.7	0.0	-62.5	-53.7	0.6	-54.6	-4.6
20.0	0.4	96.1	-8.6	0.0	-97.8	-44.9	0.0	-97.7	-45.3	0.6	-71.2	-4.2

TRL Board Layer: Top Metal → 0.5 oz CU  
 Rogers RO4350 → 0.01"  
 Inner Metal → 0.5 oz CU  
 Bottom Metal → 0.5 oz CU

### ALM-80110 K-Factor

$T_C = 25^\circ\text{C}$ ,  $V_{dd} = 5.0\text{V}$ ,  $V_{ctrl} = 5\text{V}$ ,  $V_{bias} = 4.0\text{V}$ ,  $Z_o = 50\Omega$

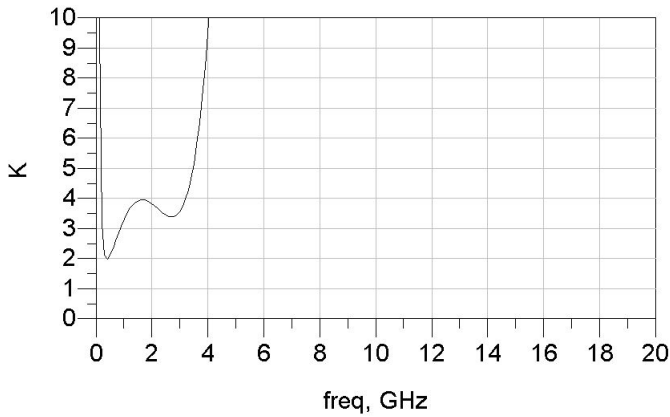

### ALM-80110 Typical Noise Parameters

$T_C = 25^\circ\text{C}$ ,  $V_{dd} = 5.0\text{V}$ ,  $V_{ctrl} = 5\text{V}$ ,  $V_{bias} = 4.0\text{V}$ ,  $Z_o = 50\Omega$

Freq (GHz)	$F_{MIN}$ (dB)	$\Gamma_{opt}$		$R_n/Z_o$ 500hm	Ga (dB)
		Mag	Ang		
0.4	4.8	0.5	-79.8	1.2	17.6
0.5	4.5	0.4	-55.8	1.2	17.5
0.6	4.4	0.4	-32.6	1.2	16.8
0.7	4.4	0.3	-10.6	1.2	15.9
0.8	4.3	0.3	11.5	1.1	15.2
0.9	4.4	0.3	30.3	1.1	14.1
1.0	4.5	0.3	46.5	1.0	13.3
1.1	4.7	0.3	61.0	1.0	12.8
1.2	4.8	0.3	72.3	1.0	12.3
1.3	5.0	0.3	82.7	1.0	11.8
1.4	5.1	0.3	91.2	0.9	11.4
1.5	5.3	0.3	99.5	0.9	11.0
1.6	5.5	0.3	106.2	0.9	10.7
1.7	5.6	0.3	113.5	0.8	10.5
1.8	5.8	0.3	119.0	0.8	10.3
1.9	5.9	0.3	125.2	0.8	10.1
2.0	6.2	0.3	130.6	0.8	9.9
2.5	7.2	0.3	155.6	0.7	9.3
3.0	8.2	0.3	171.1	1.0	8.4
3.5	8.8	0.3	-176.8	1.2	6.2
4.0	10.5	0.2	156.3	2.1	3.1
4.5	11.8	0.3	118.6	3.5	0.1
5.0	13.8	0.5	125.8	5.8	-2.6
6.0	17.3	0.8	147.4	11.1	-7.6

## PCB Layout and Stencil Design

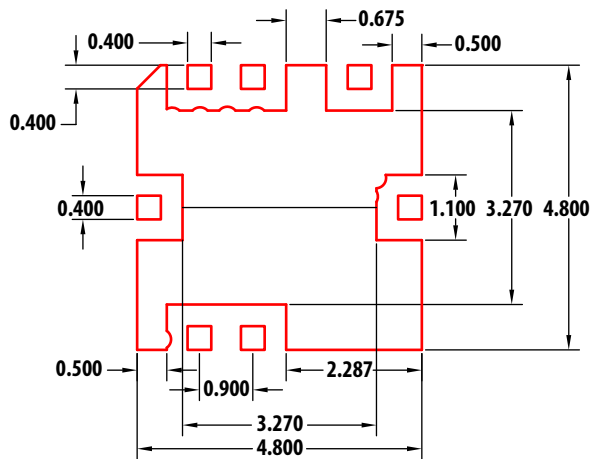

**PCB Land Pattern (Top View)**

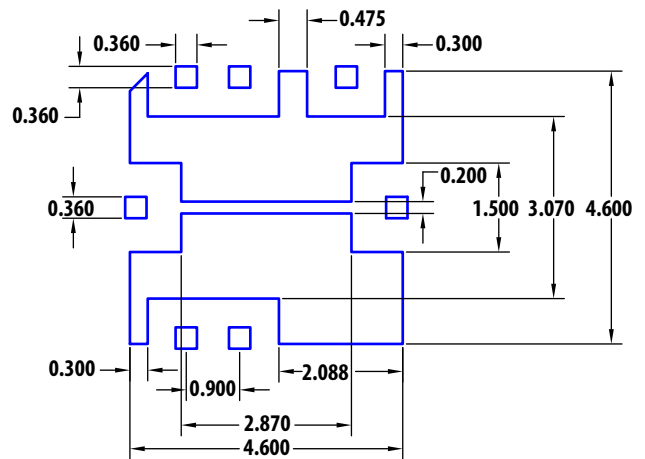

**Stencil Outline**

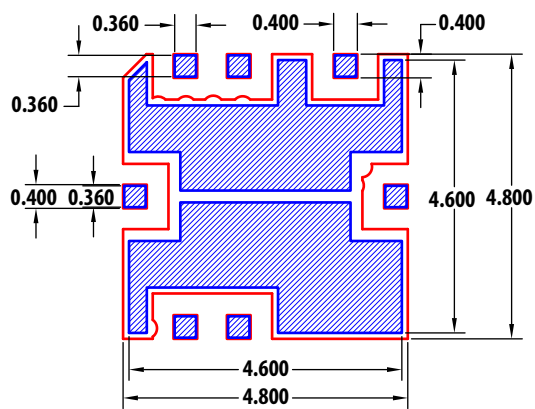

**Combined PCB & Stencil Layouts**

All Dimension are in MM

## Package Dimension

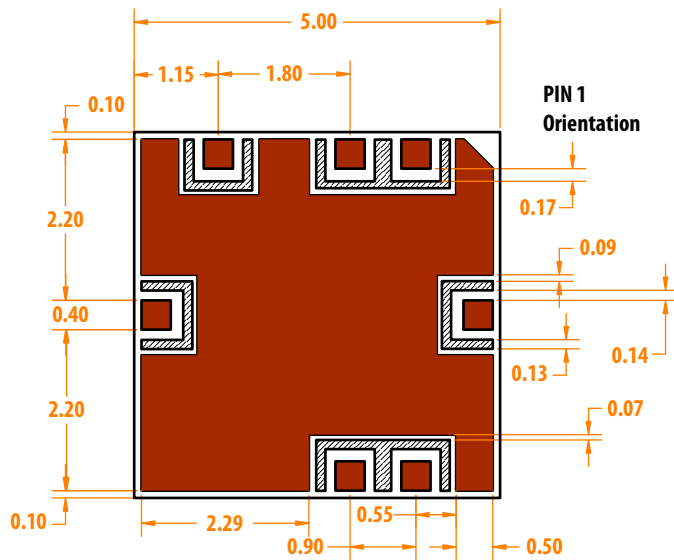
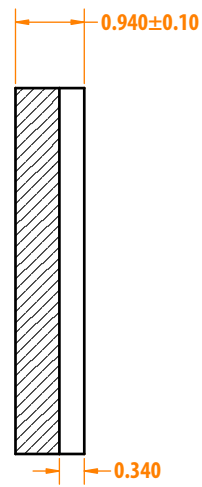
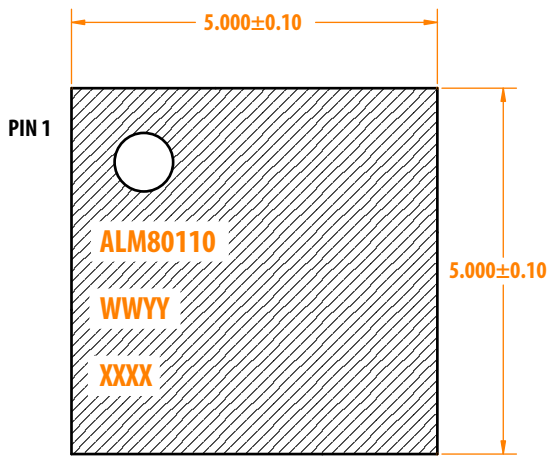

Note :

1. All dimensions are in millimeters
2. Dimensions are inclusive of plating
3. Dimensions are exclusive of mold flash and metal burr.



## Device Orientation

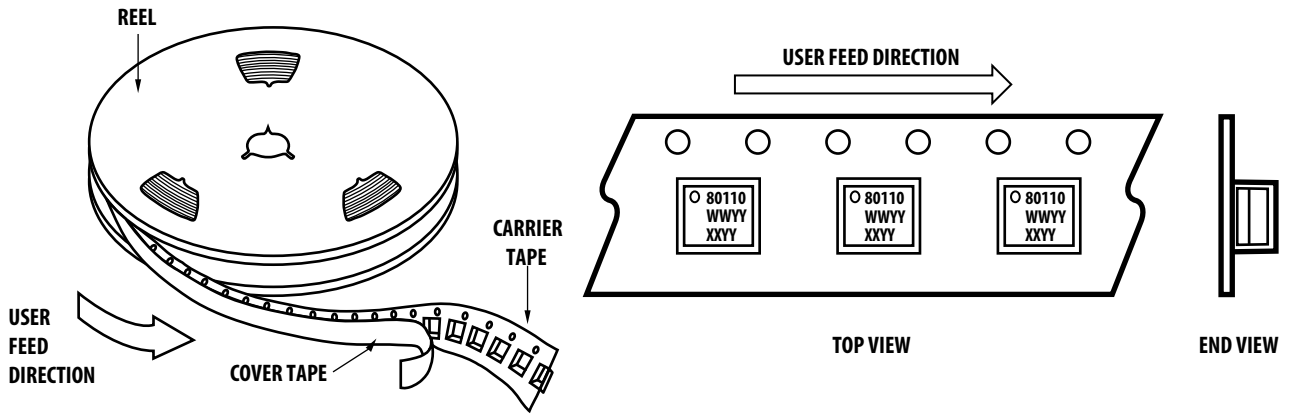

## Tape Dimensions

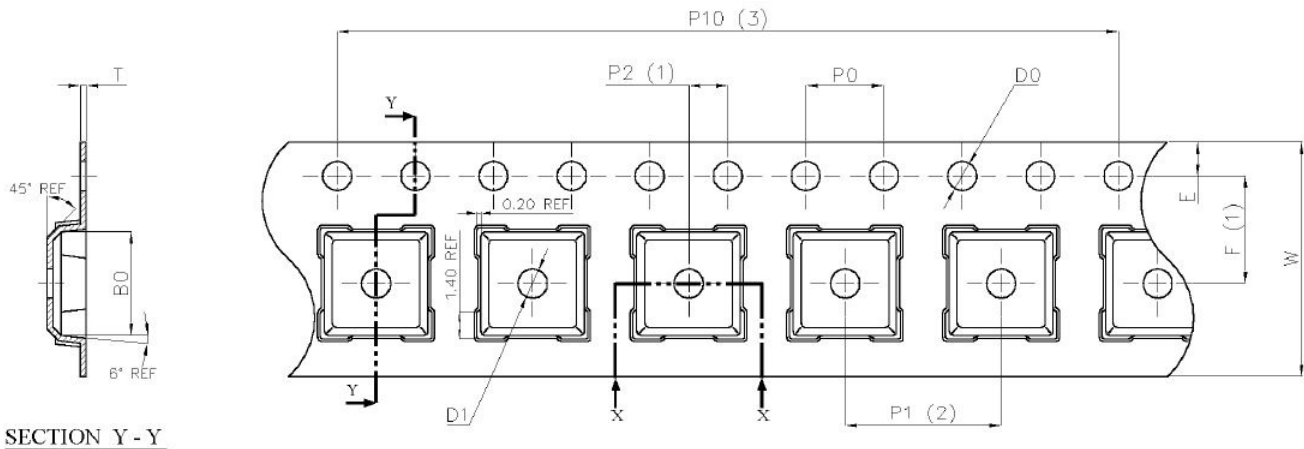

Dimension List			
Annote	Millimeter	Annote	Millimeter
A0	5.40±0.10	P0	4.00±0.10
B0	5.40±0.10	P2	2.00±0.10
D0	1.50 <sup>+0.10</sup> <sub>-0</sub>	P10	40.00±0.20
D1	1.60±0.10	E	1.75±0.10
K0	1.90±0.10	F	5.50±0.10
K1	1.50±0.10	T	0.30±0.03
P1	8.00±0.10	W	12.00±0.30

## Part Ordering Information

Part Number	No. of Devices	Container
ALM-80110-BLKG	100	Antistatic Bag
ALM-80110-TR1G	3000	13" Reel

For product information and a complete list of distributors, please go to our web site: [www.avagotech.com](http://www.avagotech.com)

Avago, Avago Technologies, and the A logo are trademarks of Avago Technologies in the United States and other countries. Data subject to change. Copyright © 2005-2014 Avago Technologies. All rights reserved.  
AV02-1970EN - August 28, 2014



## X-ON Electronics

Largest Supplier of Electrical and Electronic Components

*Click to view similar products for [RF Amplifier](#) category:*

*Click to view products by [Broadcom](#) manufacturer:*

Other Similar products are found below :

[A82-1](#) [BGA622H6820XTSA1](#) [BGA 728L7 E6327](#) [BGB719N7ESDE6327XTMA1](#) [HMC397-SX](#) [HMC405](#) [HMC561-SX](#) [HMC8120-SX](#)  
[HMC8121-SX](#) [HMC-ALH382-SX](#) [HMC-ALH476-SX](#) [SE2433T-R](#) [SMA3101-TL-E](#) [SMA39](#) [A66-1](#) [A66-3](#) [A67-1](#) [A81-2](#) [LX5535LQ](#)  
[LX5540LL](#) [MAAM02350](#) [HMC3653LP3BETR](#) [HMC549MS8GETR](#) [HMC-ALH435-SX](#) [SMA101](#) [SMA32](#) [SMA411](#) [SMA531](#)  
[SST12LP19E-QX6E](#) [WPM0510A](#) [HMC5929LS6TR](#) [HMC5879LS7TR](#) [HMC1087F10](#) [HMC1086](#) [HMC1016](#) [SMA1212](#) [MAX2689EWS+T](#)  
[MAAMSS0041TR](#) [MAAM37000-A1G](#) [LTC6430AIUF-15#PBF](#) [SMA70-2](#) [SMA4011](#) [A231](#) [HMC-AUH232](#) [LX5511LQ](#) [LX5511LQ-TR](#)  
[HMC7441-SX](#) [HMC-ALH310](#) [XD1001-BD-000V](#) [A4011](#)