

# ALM-80210

## 0.25W Analog Variable Gain Amplifier

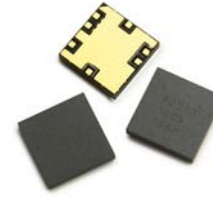

### Data Sheet



#### Description

Avago Technologies ALM-80210 is a 0.25W Analog Controlled Variable Gain Amplifier which operates from 1.6GHz to 2.7GHz. The device provides an exceptionally high OIP3 level of 39.5dBm, which is maintained over a wide attenuation range. The device features wide gain control range, low current, excellent input and output return loss.

The ALM-80210 is housed in a miniature 5.0X5.0X1.1 mm<sup>3</sup>, 10-lead multiple-chips-on-board (MCOB) module package. This part is suitable for the AGC/Temperature compensation circuits application in wireless infrastructure such as Cellular/PCS/W-CDMA/WLLand and new generation wireless technologies systems.

#### Pin connections and Package Marking

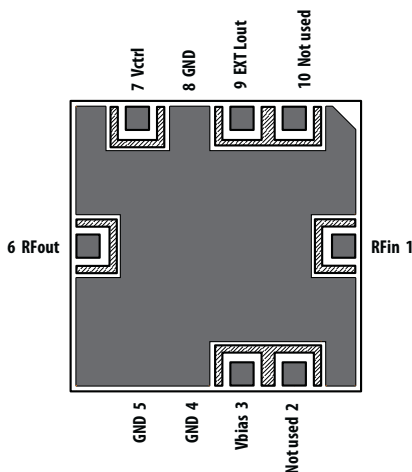

Note :  
Top View : Package marking provides orientation and identification  
"80210" = Device Code  
"WWYY" = Workweek and Year Code  
"XXXX" = Assembly Lot number

#### Features

- Halogen free
- Wide Gain Control Range
- High OIP3 across attenuation range

#### Specifications

At 1.9GHz,  $V_{dd} = 5V$ ,  $I_{total} = 112mA$  (typ),  $V_{bias} = 4V$ ,  $V_{ctrl} = 5V$  @ 25°C

- OIP3 = 40.5dBm
- Noise Figure = 5.2dB
- Gain = 9.8dB
- P1dB = 23.2dBm
- IRL = 13.6dB, ORL = 12.1dB
- Dynamic Range = 35dB

#### Application

- CDMA, W-CDMA, WiMAX, LTE and other applications in the 1.6GHz to 2.7GHz range.
- Transmitter and Receiver Gain Control
- Temperature Compensation Circuitry



**Attention: Observe precautions for handling electrostatic sensitive devices.**  
ESD Machine Model = 90V  
ESD Human Body Model = 650V  
Refer to Avago Application Note A004R: Electrostatic Discharge, Damage and Control.

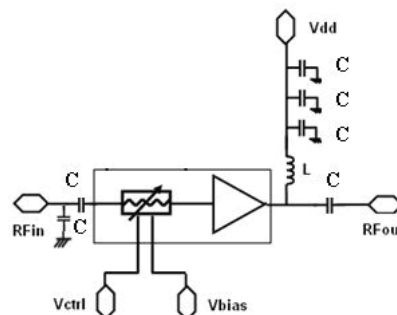

Figure 1. Simplified Schematic diagram

## ALM-80210 Absolute Maximum Rating (1)

$T_C = 25^\circ\text{C}$

Symbol	Parameter	Units	Absolute Maximum
$I_{d,max}$	Drain Current	mA	140
$V_{d,max}$	Drain Voltage, RF output to ground	V	5.5
$V_{ctrl,max}$	Control Voltage	V	7
$V_{bias,max}$	Biasing Voltage	V	15
$P_d$	Power Dissipation	mW	770
$P_{in}$	CW RF Input Power (4)	dBm	25
$T_j$	Junction Temperature	$^\circ\text{C}$	150

## Thermal Resistance (2,3)

( $V_d = 5.0\text{V}$ )  $\theta_{jc} = 70^\circ\text{C/W}$

Notes:

1. Operation of this device in excess of any of these limits may cause permanent damage
2. Derate  $14.3\text{mW}/^\circ\text{C}$  for  $T_L > 97^\circ\text{C}$
3. Thermal resistance measured using  $150^\circ\text{C}$  Infra-Red Microscopy Technique.
4. Max rating for  $P_{in}$  is under maximum attenuation condition i.e.  $V_{ctrl} = 1\text{V}$ .

## ALM-80210 Electrical Specification (1)

$T_C = 25^\circ\text{C}$ ,  $Z_o = 50\Omega$ ,  $V_{dd} = 5.0\text{V}$ ,  $V_{bias} = 4\text{V}$ ,  $V_{ctrl} = 5\text{V}$  unless noted

Symbol	Parameter and Test Condition	Frequency	Units	Min.	Typ.	Max.	stdev(4)
$I_{dd}$	Operating Amplifier Current Range	N/A	mA	89	112	134	0.002
NF	Noise Figure at minimal Attenuation	1.9GHz 2.1GHz 2.5GHz	dB		5.2 5.4 5.7	5.9	0.088
Gain	Gain at minimal Attenuation	1.9GHz 2.1GHz 2.5GHz	dB	8.2	9.8 9.7 9.5	11.2	0.148
OIP3(2)	Output Third Order Intercept Point	1.9GHz 2.1GHz 2.5GHz	dBm	36	40.5 39.5 39.8		0.616
P1dB	Output Power at 1dB Gain Compression	1.9GHz 2.1GHz 2.5GHz	dBm	22	23.5 23..5 23.3		0.112
IRL	Input Return Loss	1.9GHz 2.1GHz 2.5GHz	dB		13.6 14.9 18.5		NA
ORL	Output Return Loss	1.9GHz 2.1GHz 2.5GHz	dB		12.1 14.3 14.8		NA
ISO	Isolation	1.9GHz 2.1GHz 2.5GHz	dB		28.6 27.7 26.7		NA
$V_{bias}$	Attenuator Bias Voltage	N/A	V	2.7	4	5	N/A
$V_{ctrl}$	Gain Variation Control Voltage	N/A	V	1	-	5	NA
$\Delta$ Gain	Gain Variation Range (from $V_{ctrl}=1\text{V}$ to $5\text{V}$ )	1.9GHz 2.1GHz 2.5GHz	dB		35.0 35.1 34.3		NA

Note :

1. Measurements obtained from a test circuit described in Figure 53.
2. OIP3 test condition:  $F_1 - F_2 = 10\text{MHz}$ , with input power of  $-10\text{dBm}$  per tone measured at worst case side band.
3. Standard deviation data are based on at least 1000 pieces samples size taken from 2 wafer lots. Future wafers allocated to this product may have nominal values anywhere between the upper and lower specification limits.

## ALM-80210 Product Consistency Distribution at 1900MHz

$T_C = 25^\circ\text{C}$ ,  $V_{dd} = 5.0\text{V}$ ,  $V_{bias} = 4.0\text{V}$

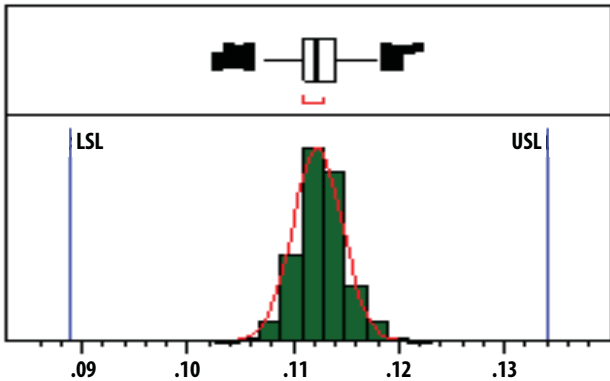

Figure 2. Itotal at 1900MHz

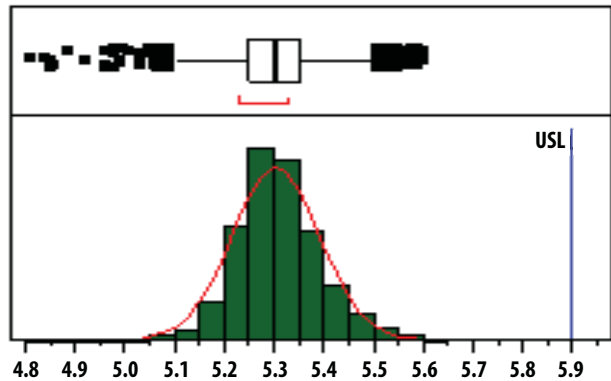

Figure 3. NF at 1900MHz

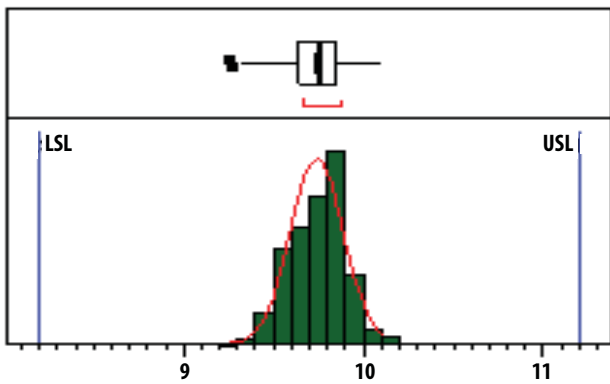

Figure 4. Gain at 1900MHz

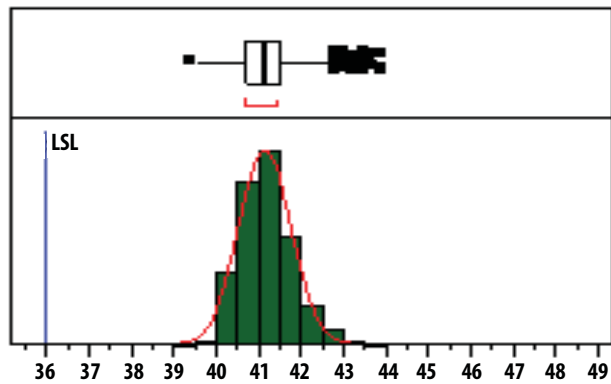

Figure 5. OIP3 at 1900MHz

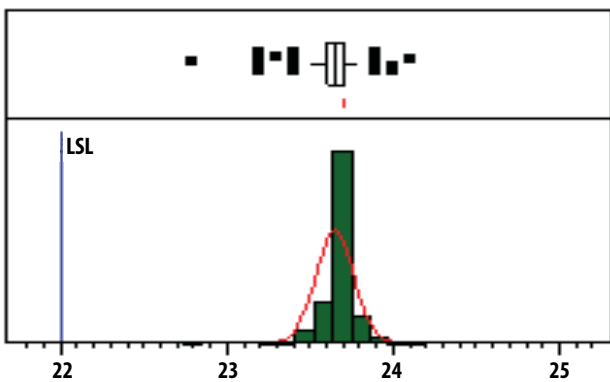

Figure 6. P1dB at 1900MHz

### Note:

1. Statistics distribution determined from a sample size of 1000 parts taken from 2 different wafers.
2. Future wafers allocation to this product may have typical values anywhere between the minimum and maximum specification limits.
3. Measurements are made on production testboard, which represents a trade-off between optimal OIP3, P1dB and NF. Circuit losses have been de-embedded from actual measurements.

# ALM-80210 Application Circuit Data for 1900MHz

$T_C = 25^\circ\text{C}$ ,  $V_{dd} = 5.0\text{V}$ ,  $V_{bias} = 4.0\text{V}$

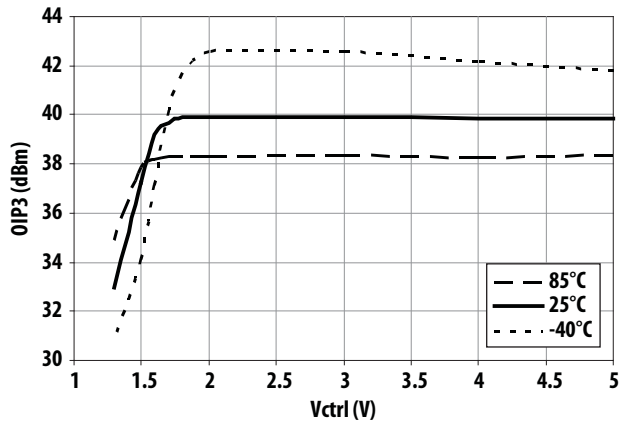

Figure 7. OIP3 vs Control Voltage and Temperature at 1900MHz

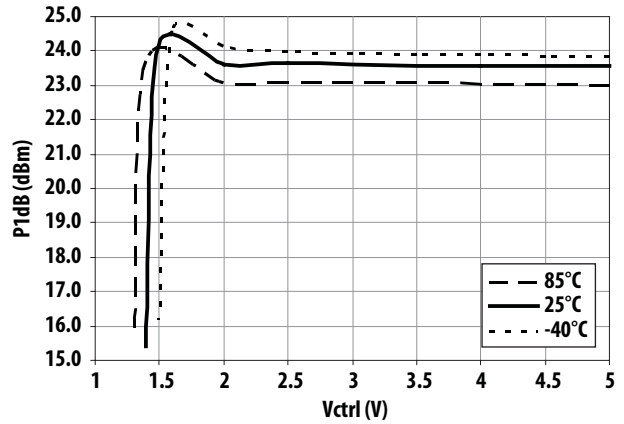

Figure 8. P1dB vs Control Voltage and Temperature at 1900MHz

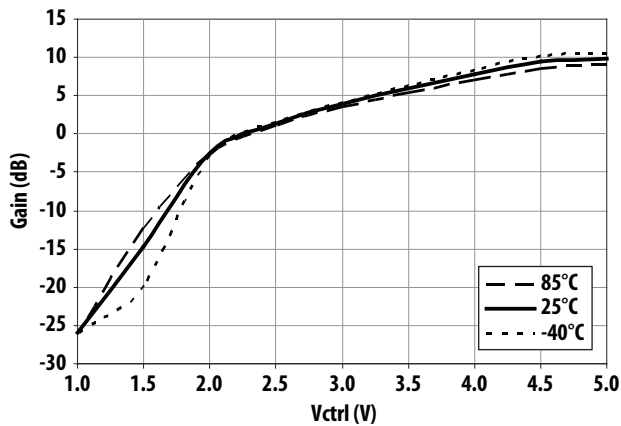

Figure 9. Gain vs Control Voltage and Temperature at 1900MHz

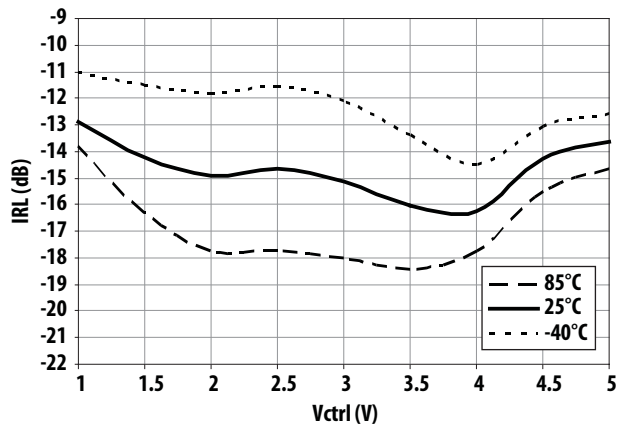

Figure 10. IRL vs Control Voltage and Temperature at 1900MHz

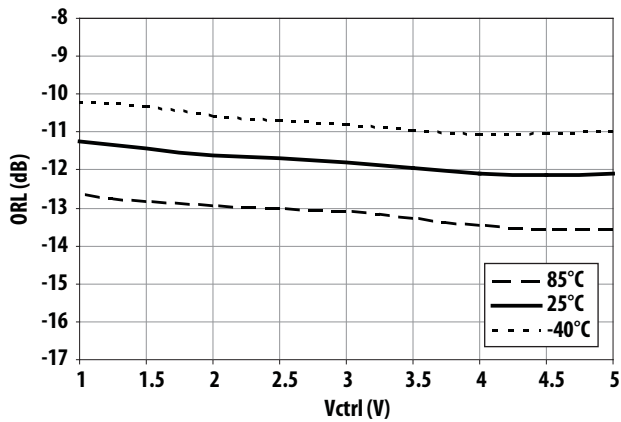

Figure 11. ORL vs Control Voltage and Temperature at 1900MHz

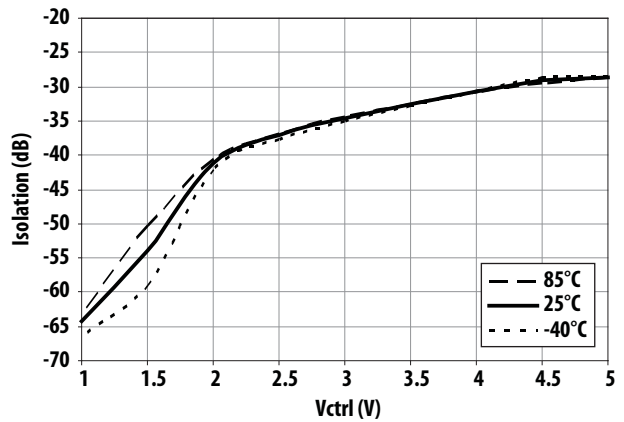

Figure 12. Isolation vs Control Voltage and Temperature at 1900MHz

# ALM-80210 Application Circuit Data for 1900MHz (cont'd)

$T_C = 25^\circ\text{C}$ ,  $V_{dd} = 5.0\text{V}$ ,  $V_{bias} = 4.0\text{V}$

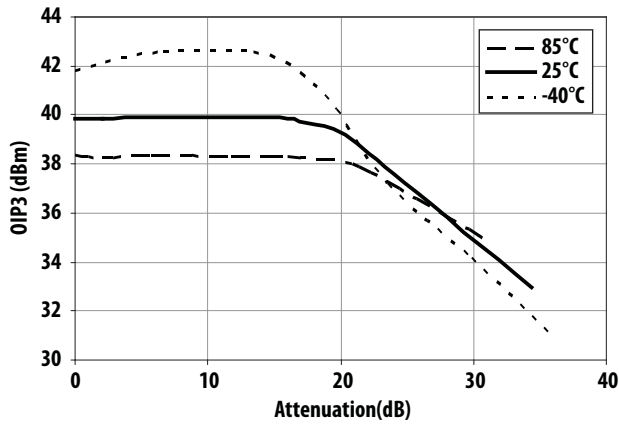

Figure 13. OIP3 vs Attenuation and Temperature at 1900MHz

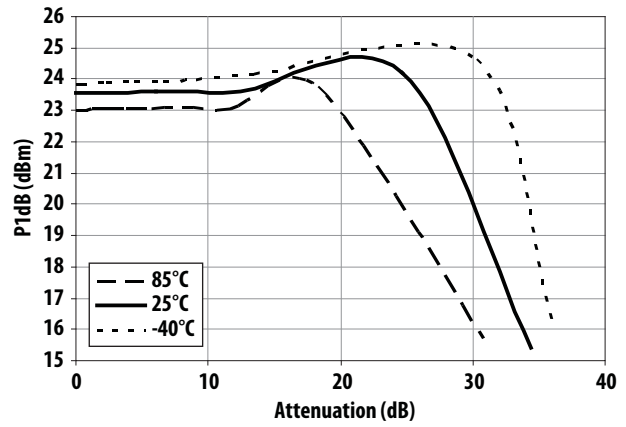

Figure 14. P1dB vs Attenuation and Temperature at 1900MHz

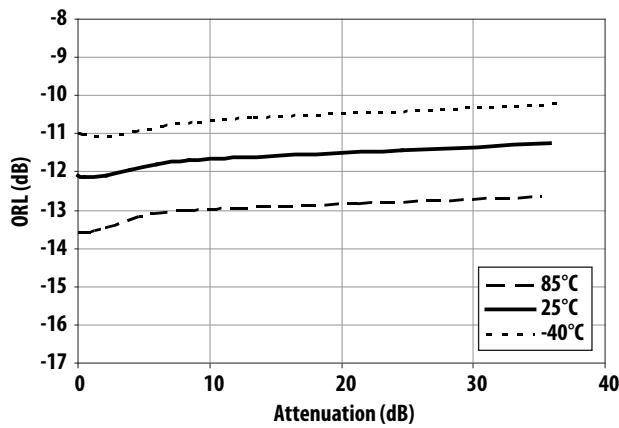

Figure 15. ORL vs Attenuation and Temperature at 1900MHz

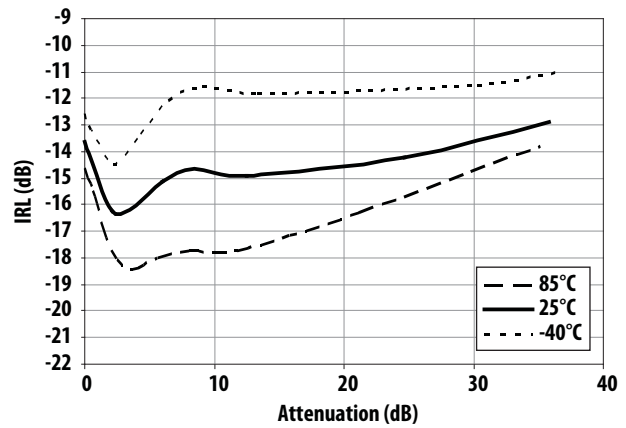

Figure 16. IRL vs Attenuation and Temperature at 1900MHz

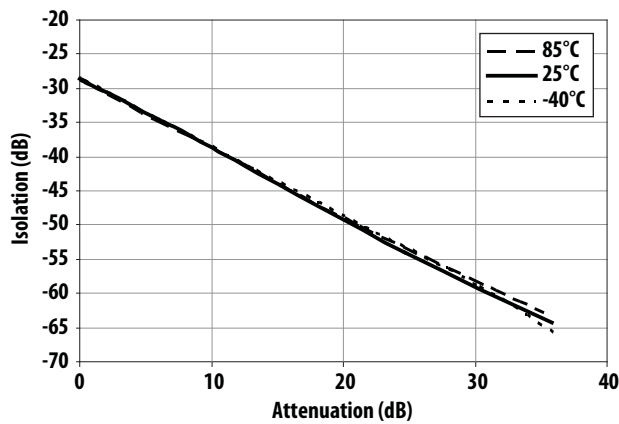

Figure 17. Isolation vs Attenuation and Temperature at 1900MHz

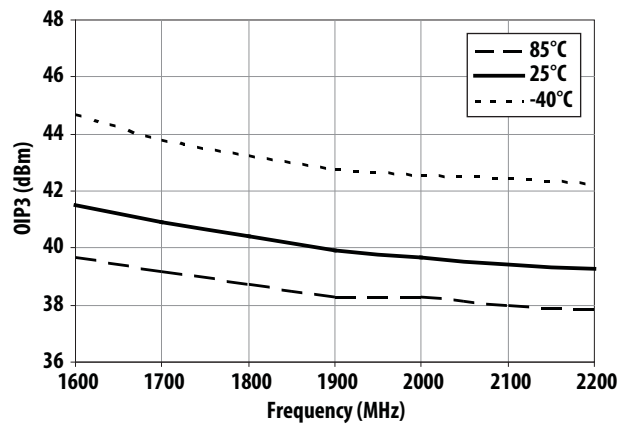

Figure 18. OIP3 vs Frequency and Temperature at  $V_{ctrl} = 5\text{V}$

# ALM-80210 Application Circuit Data for 1900MHz (cont'd)

$T_C = 25^\circ\text{C}$ ,  $V_{dd} = 5.0\text{V}$ ,  $V_{bias} = 4.0\text{V}$

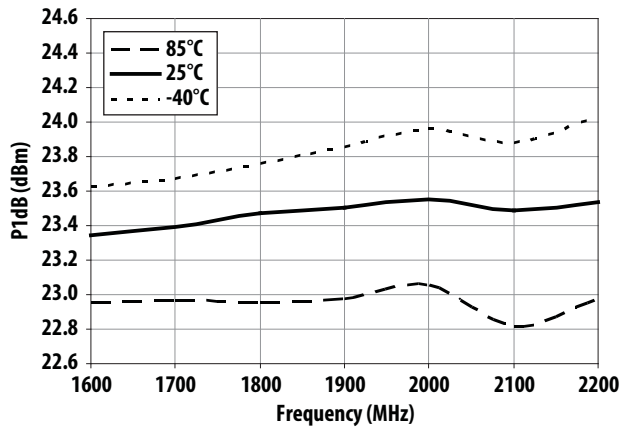

Figure 19. P1dB vs Frequency and Temperature at  $V_{ctrl} = 5\text{V}$

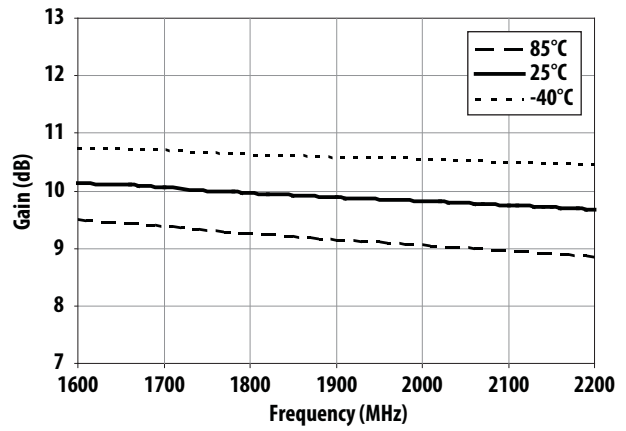

Figure 20. Gain vs Frequency and Temperature at  $V_{ctrl} = 5\text{V}$

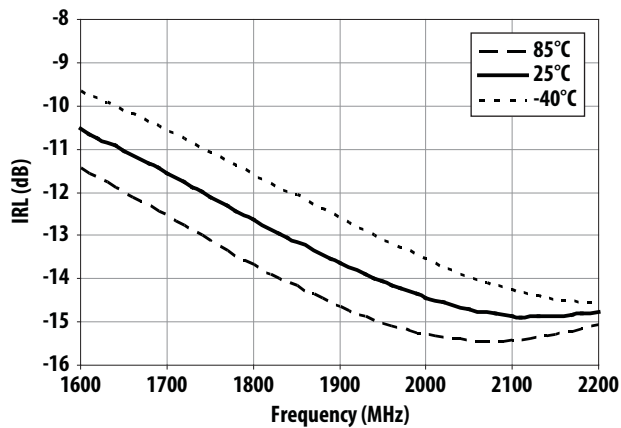

Figure 21. IRL vs Frequency and Temperature at  $V_{ctrl} = 5\text{V}$

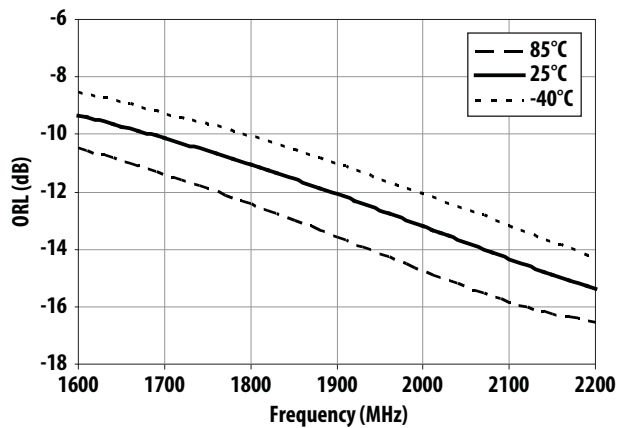

Figure 22. ORL vs. Frequency and Temperature at  $V_{ctrl} = 5\text{V}$

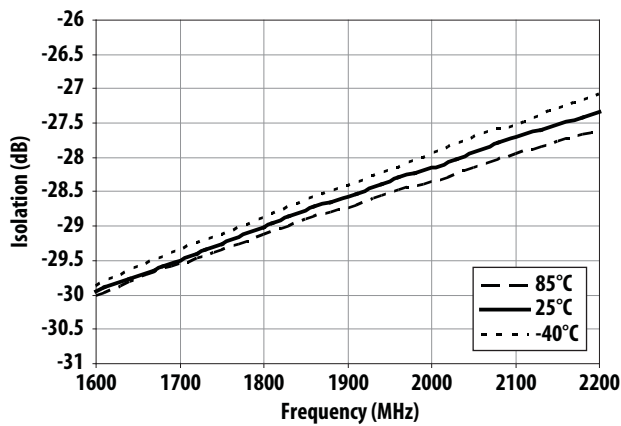

Figure 23. Isolation vs Frequency and Temperature at  $V_{ctrl} = 5\text{V}$

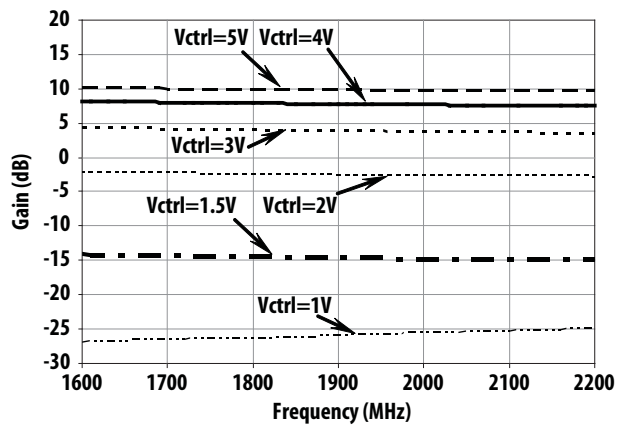

Figure 24. Gain vs Frequency and Control Voltage

# ALM-80210 Application Circuit Data for 1900MHz (cont'd)

$T_C = 25^\circ\text{C}$ ,  $V_{dd} = 5.0\text{V}$ ,  $V_{bias} = 4.0\text{V}$

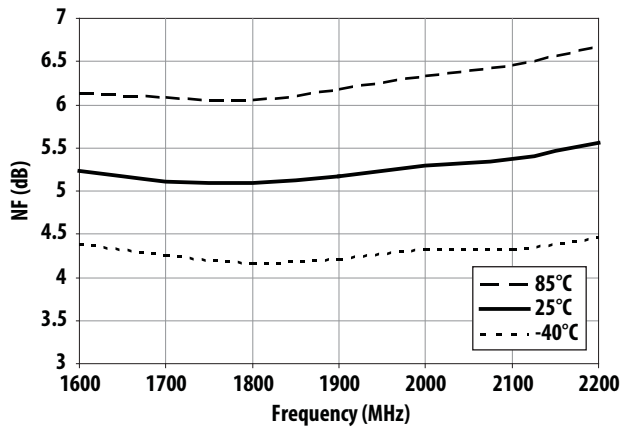

Figure 25. Noise Figure vs Frequency and Temperature at  $V_{ctrl} = 5\text{V}$

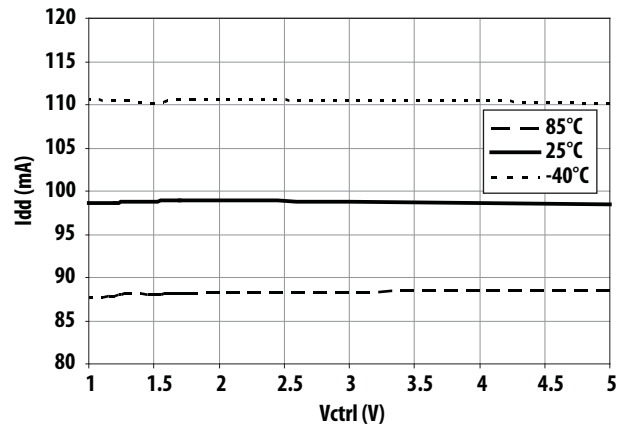

Figure 26. Current ( $I_{dd}$ ) vs Control Voltage and Temperature

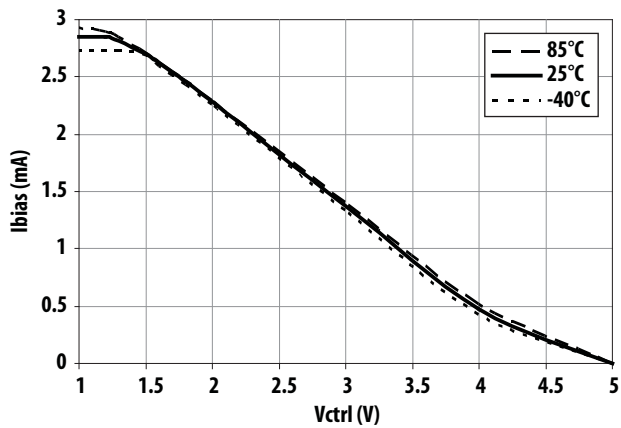

Figure 27. Current ( $I_{bias}$ ) vs Control Voltage and Temperature

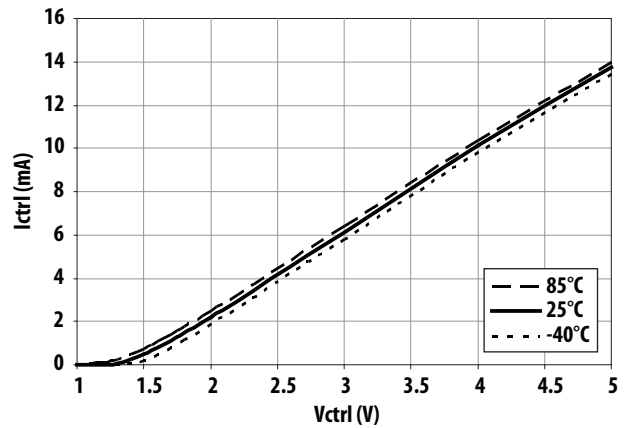

Figure 28. Current ( $I_{ctrl}$ ) vs Control Voltage and Temperature

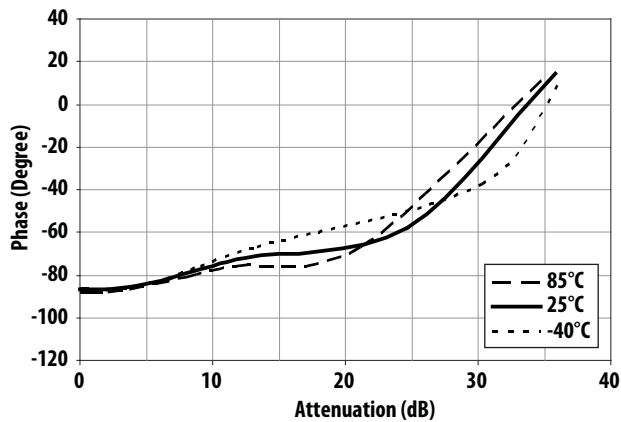

Figure 29. Phase vs Attenuation and Temperature at 1900MHz (without external L1 as shown in Figure 54)

## ALM-80210 Application Circuit Data for 2500MHz

$T_C = 25^\circ\text{C}$ ,  $V_{dd} = 5.0\text{V}$ ,  $V_{bias} = 4.0\text{V}$

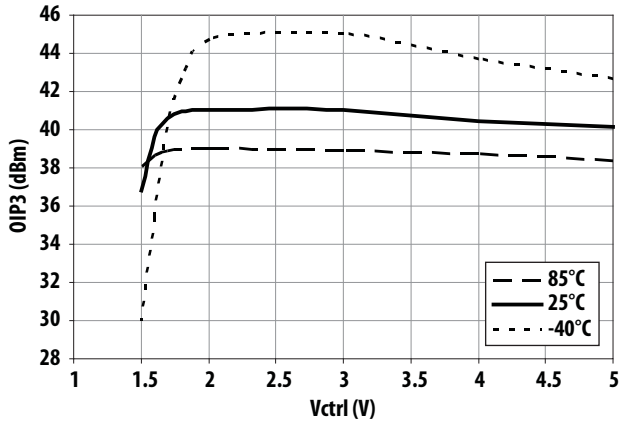

Figure 30. OIP3 vs Control Voltage and Temperature at 2500MHz

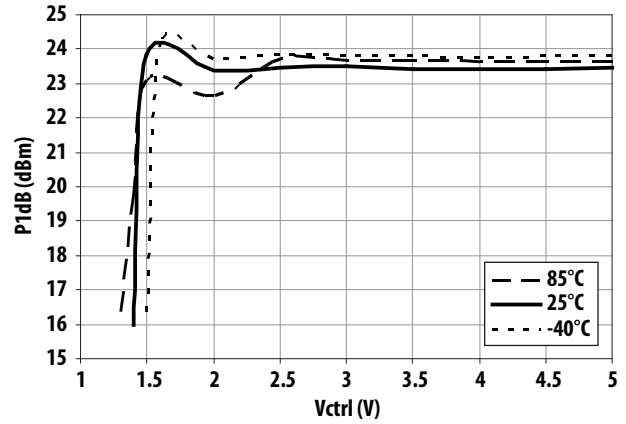

Figure 31. P1dB vs Control Voltage and Temperature at 2500MHz

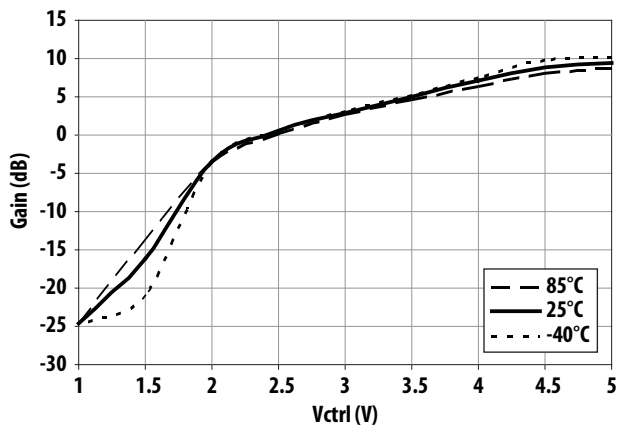

Figure 32. Gain vs Control Voltage and Temperature at 2500MHz

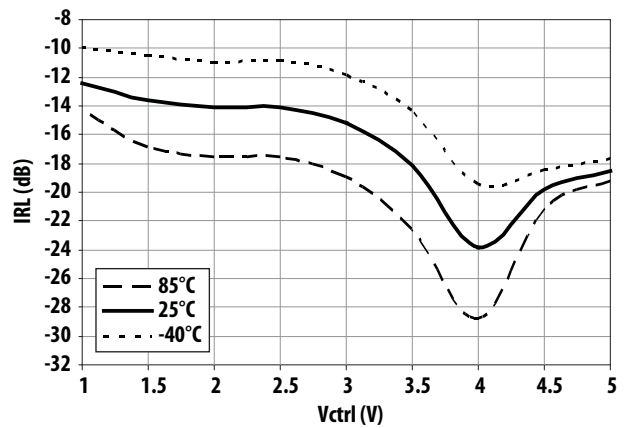

Figure 33. IRL vs Control Voltage and Temperature at 2500MHz

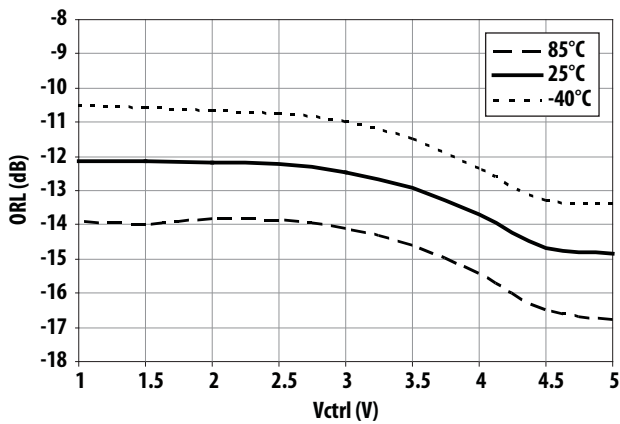

Figure 34. ORL vs Control Voltage and Temperature at 2500MHz

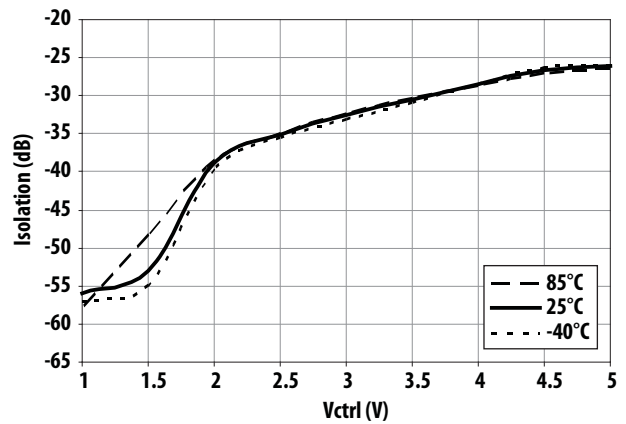

Figure 35. Isolation vs Control Voltage and Temperature at 2500MHz



# ALM-80210 Application Circuit Data for 2500MHz (cont'd)

$T_C = 25^\circ\text{C}$ ,  $V_{dd} = 5.0\text{V}$ ,  $V_{bias} = 4.0\text{V}$

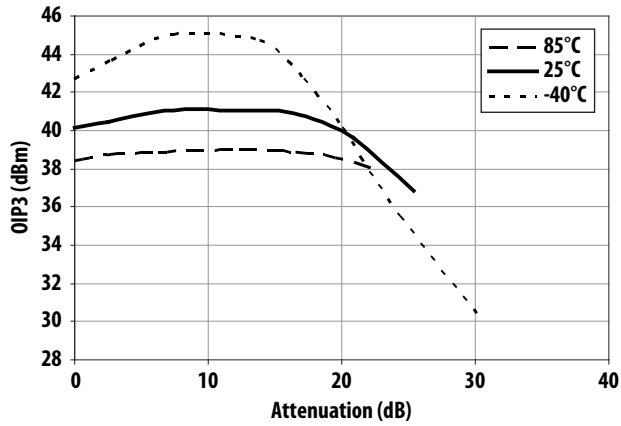

Figure 36. OIP3 vs Attenuation and Temperature at 2500MHz

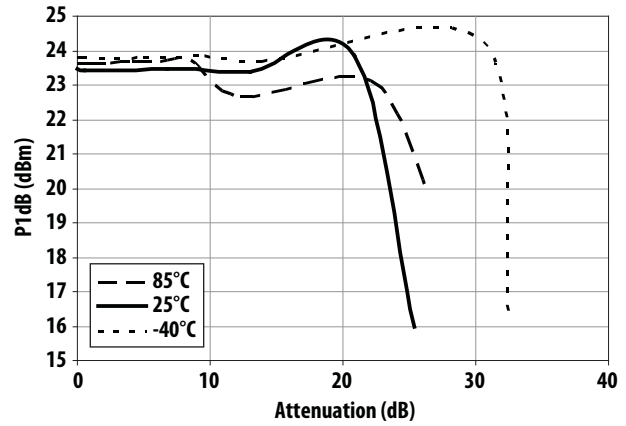

Figure 37. P1dB vs Attenuation and Temperature at 2500MHz

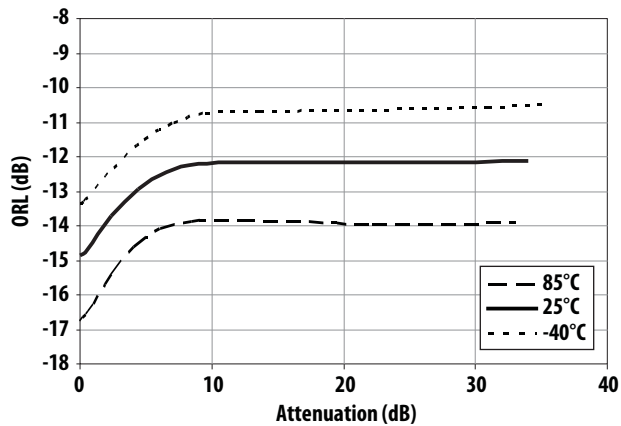

Figure 38. ORL vs Attenuation and Temperature at 2500MHz

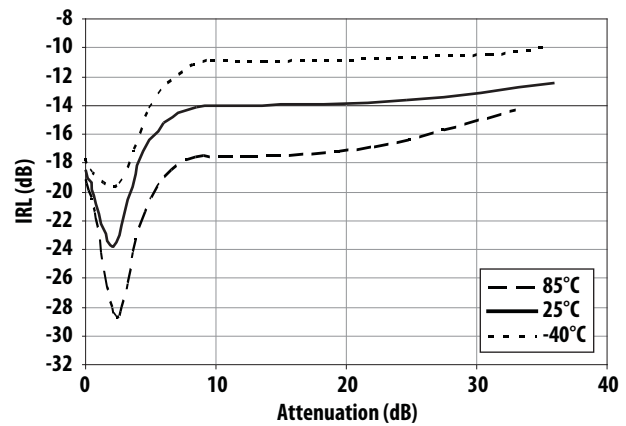

Figure 39. IRL vs Attenuation and Temperature at 2500MHz

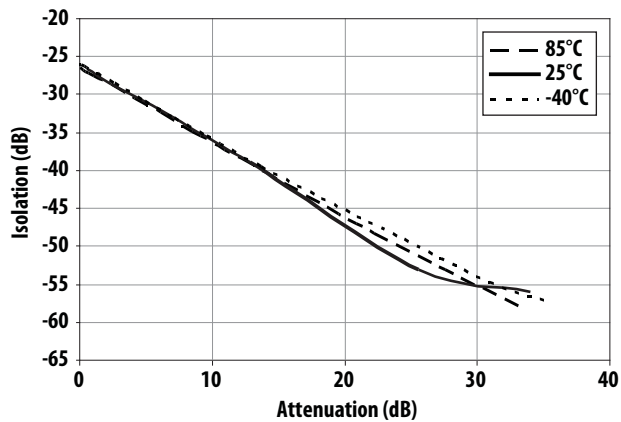

Figure 40. Isolation vs Attenuation and Temperature at 2500MHz

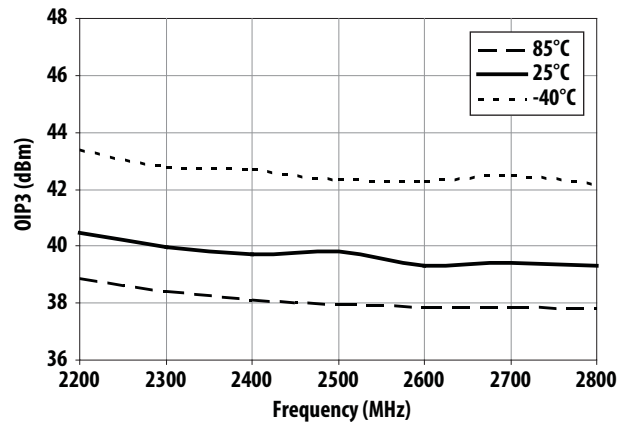

Figure 41. OIP3 vs Frequency and Temperature at  $V_{ctrl} = 5\text{V}$

**ALM-80210 Application Circuit Data for 2500MHz (cont'd)**

$T_C = 25^\circ\text{C}$ ,  $V_{dd} = 5.0\text{V}$ ,  $V_{bias} = 4.0\text{V}$

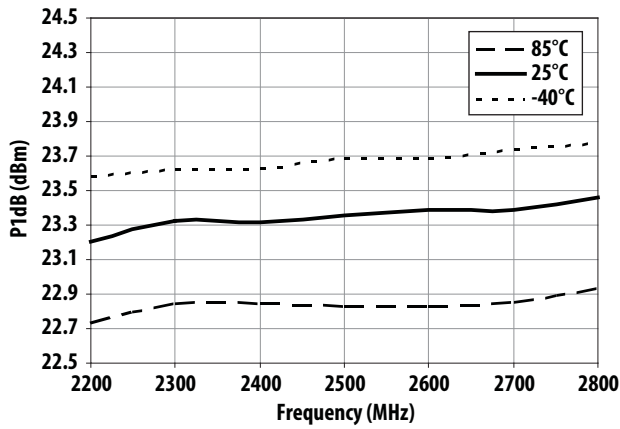

Figure 42. P1dB vs Frequency and Temperature at  $V_{ctrl} = 5\text{V}$

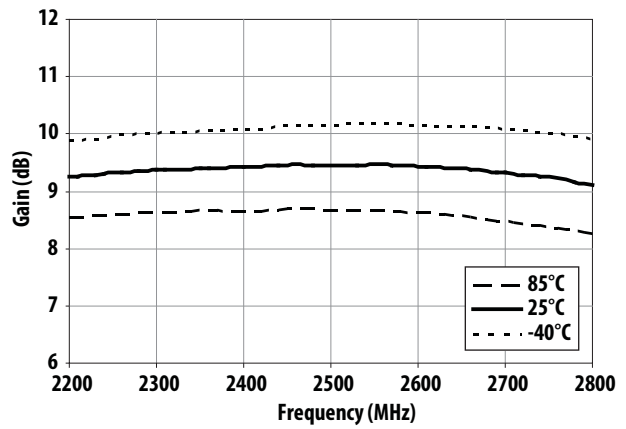

Figure 43. Gain vs Frequency and Temperature at  $V_{ctrl} = 5\text{V}$

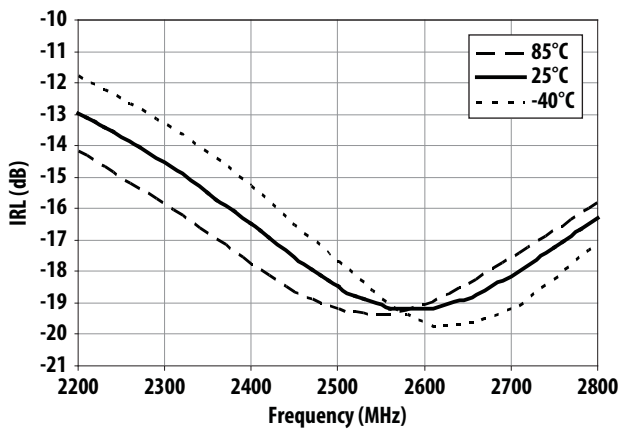

Figure 44. IRL vs Frequency and Temperature at  $V_{ctrl} = 5\text{V}$

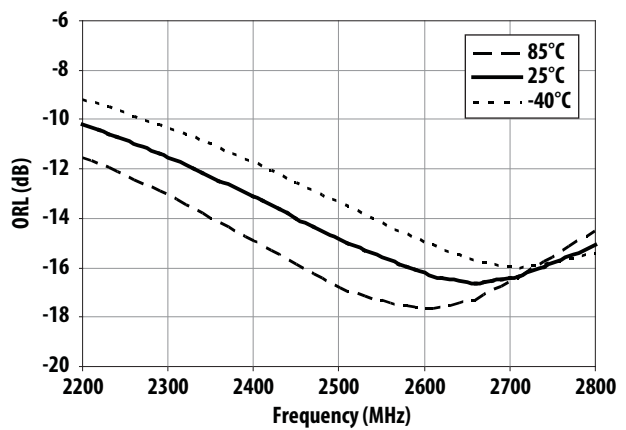

Figure 45. ORL vs. Frequency and Temperature at  $V_{ctrl} = 5\text{V}$

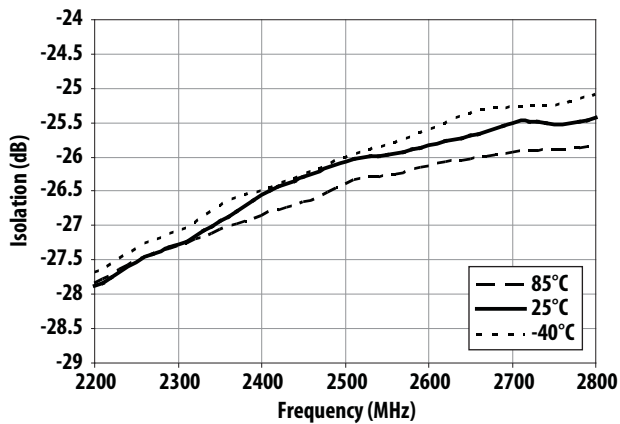

Figure 46. Isolation vs Frequency and Temperature at  $V_{ctrl} = 5\text{V}$

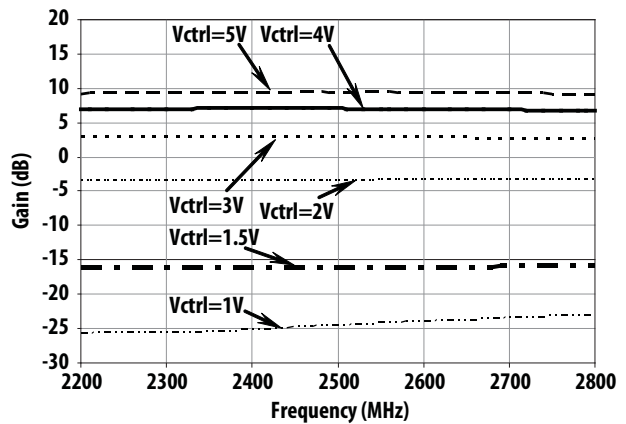

Figure 47. Gain vs Frequency and Control Voltage

## ALM-80210 Application Circuit Data for 2500MHz (cont'd)

$T_C = 25^\circ\text{C}$ ,  $V_{dd} = 5.0\text{V}$ ,  $V_{bias} = 4.0\text{V}$

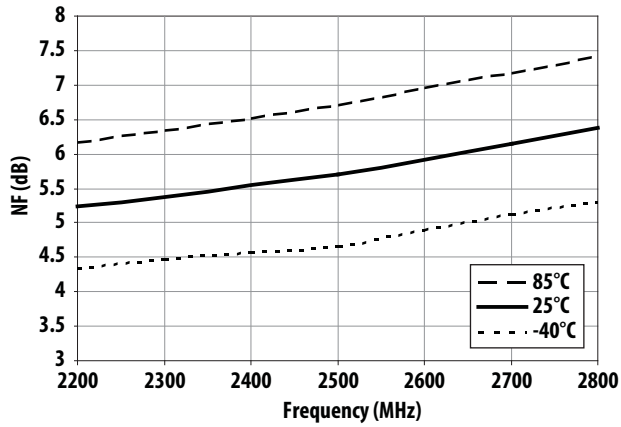

Figure 48. Noise Figure vs Frequency and Temperature at  $V_{ctrl} = 5\text{V}$

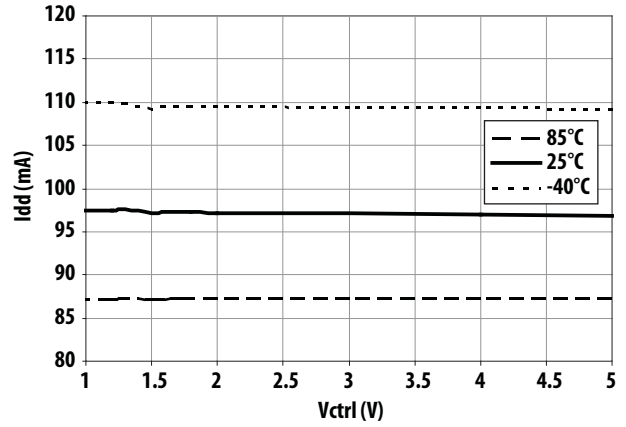

Figure 49. Current ( $I_{dd}$ ) vs Control Voltage and Temperature

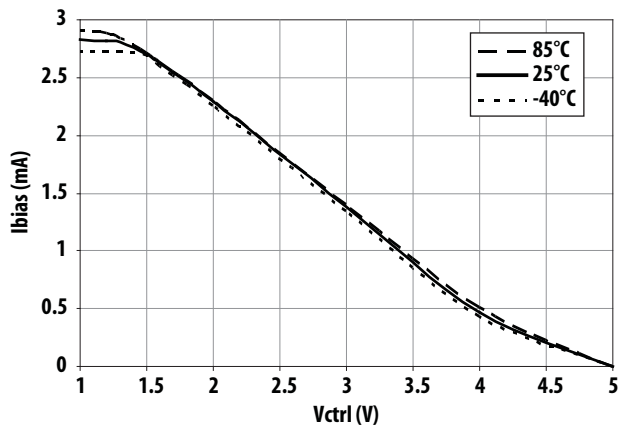

Figure 50. Current ( $I_{bias}$ ) vs Control Voltage and Temperature

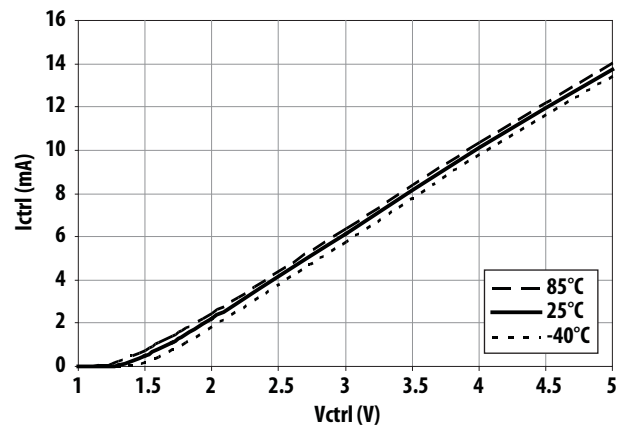

Figure 51. Current ( $I_{ctrl}$ ) vs Control Voltage and Temperature

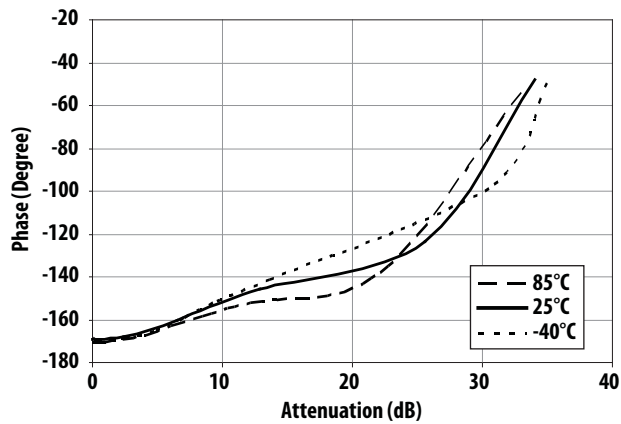

Figure 52. Phase vs Attenuation and Temperature at 2500MHz (without external L1 as shown in Figure 54)

## Application Circuit Description and Layout

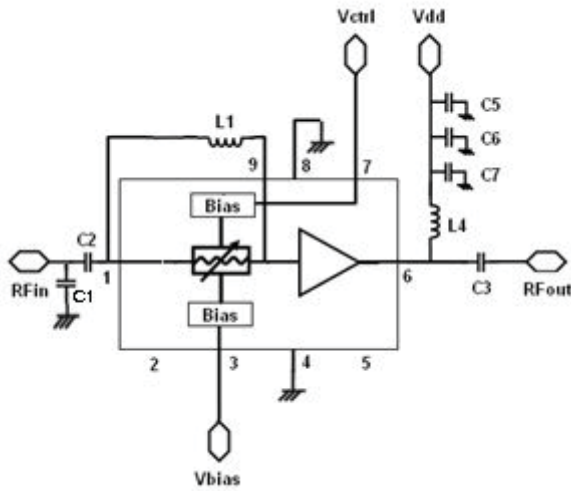
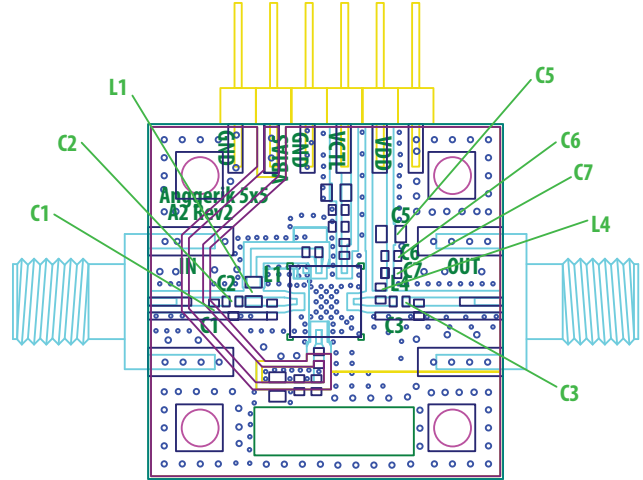

Figure 53. Demoboard schematic and layout



## Bill of Materials

Circuit Symbol	Size	Description			
		For 1.9GHz		For 2.5GHz	
C1	0402	0.4pF	Murata	NA	
C2	0402	27pF	Murata	100pF	Murata
C3	0402	100pF	Murata	100pF	Murata
C5	0603	2.2uF	Murata	2.2uF	Murata
C6	0402	0.1uF	Murata	0.1uF	Murata
C7	0402	15pF	Murata	3pF	Murata
L1	0402	NA		NA	
L4	0402	12nH	Toko	3.9nH	Toko

Note: For L1, please refer to Figure 54

ALM-80210 is an input fully matched and output pre-matched product. The product requires 3 biasing points i.e. Vdd (to bias up the PA), Vbias and Vctrl (for controlling the attenuator circuitry). The Vdd is connected to the output pin through a RF choke, L4 (which isolates the inband signal from the DC supply). The bypass capacitor (C5, C6 and C7) helps to eliminate out of band low frequency signals. DC blocking capacitors (C2 and C3) are required for its input and output, to isolate the supply voltage from succeeding circuits. To improve input return loss, C1 is being used for external tuning.

The external Inductor (L1), helps to stabilize the attenuator performance (by gain flatness and change of phase) for the frequency of interest as well as improving its dynamic range.

ALM-80210's gain is adjusted by supplying a voltage through Vctrl. For absolute dynamic range, Vctrl can operate from 0.8 to 5V, but for best linearity, Vctrl above 1V is recommended.

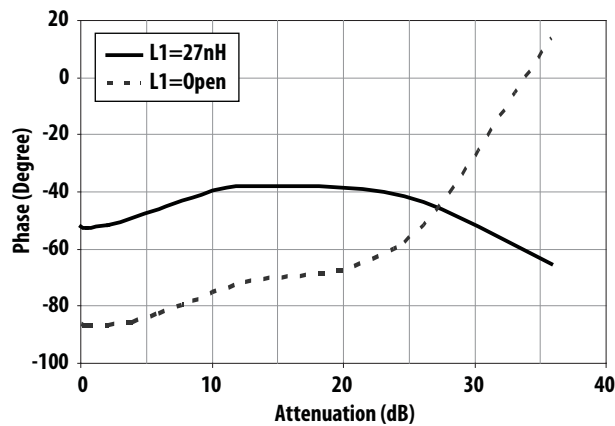

Figure 54. Phase vs Attenuation with and without External L1 at 1900MHz

## ALM-80210 Typical Scatter Parameters

$T_c = 25^\circ\text{C}$ ,  $V_{dd} = 5.0\text{V}$ ,  $V_{ctrl} = 5\text{V}$ ,  $V_{bias} = 4.0\text{V}$ ,  $Z_0 = 50\Omega$

Freq GHz	S11			S21			S12			S22		
	Mag.	Ang.	dB	Mag.	Ang.	dB	Mag.	Ang.	dB	Mag.	Ang.	dB
0.1	1.0	173.2	-0.3	0.2	-57.1	-14.1	0.0	127.0	-56.6	0.1	-71.6	-71.6
0.2	0.9	167.3	-0.6	0.7	-78.5	-3.7	0.0	148.2	-53.4	0.2	-88.5	-88.5
0.3	0.9	162.3	-0.8	1.2	-99.5	1.3	0.0	115.7	-47.2	0.2	-100.9	-100.9
0.4	0.9	157.2	-1.0	1.7	-118.9	4.5	0.0	109.3	-43.7	0.2	-111.4	-111.4
0.5	0.9	151.8	-1.2	2.2	-137.1	6.7	0.0	99.5	-41.5	0.3	-120.6	-120.6
0.6	0.8	146.1	-1.5	2.6	-154.5	8.3	0.0	87.1	-38.6	0.3	-129.6	-129.6
0.7	0.8	140.3	-1.9	3.0	-171.4	9.4	0.0	79.3	-37.0	0.4	-138.8	-138.8
0.8	0.8	134.8	-2.4	3.2	172.7	10.1	0.0	70.9	-35.3	0.4	-147.7	-147.7
0.9	0.7	129.5	-3.0	3.4	157.5	10.5	0.0	59.1	-34.2	0.4	-156.1	-156.1
1.0	0.7	124.0	-3.7	3.5	143.4	10.8	0.0	50.1	-33.1	0.4	-163.8	-163.8
1.1	0.6	118.5	-4.4	3.5	130.3	10.9	0.0	41.3	-32.4	0.4	-171.1	-171.1
1.2	0.6	114.5	-5.1	3.5	118.3	10.8	0.0	34.5	-31.7	0.4	-177.7	-177.7
1.3	0.5	110.7	-5.7	3.4	107.2	10.7	0.0	26.7	-31.1	0.3	176.6	176.6
1.4	0.5	106.8	-6.3	3.4	96.9	10.5	0.0	19.6	-30.6	0.3	171.4	171.4
1.5	0.4	103.1	-7.0	3.3	87.0	10.4	0.0	13.5	-30.2	0.3	166.9	166.9
1.6	0.4	98.9	-7.5	3.3	77.7	10.3	0.0	7.2	-29.6	0.3	162.9	162.9
1.7	0.4	94.6	-8.2	3.2	68.6	10.1	0.0	1.2	-29.3	0.3	159.6	159.6
1.8	0.4	90.0	-8.8	3.2	59.9	10.1	0.0	-5.1	-28.9	0.2	157.2	157.2
1.9	0.3	84.8	-9.5	3.2	51.0	10.0	0.0	-12.0	-28.4	0.2	155.6	155.6
2.0	0.3	79.1	-10.3	3.1	42.3	9.9	0.0	-17.7	-27.9	0.2	155.2	155.2
2.1	0.3	72.7	-11.2	3.1	33.5	9.9	0.0	-25.0	-27.4	0.2	156.9	156.9
2.2	0.2	65.3	-12.4	3.1	24.4	9.9	0.0	-30.8	-26.9	0.1	162.4	162.4
2.3	0.2	57.1	-13.9	3.1	15.4	9.9	0.0	-39.1	-26.5	0.1	171.9	171.9
2.4	0.2	46.2	-15.9	3.1	5.8	9.9	0.0	-46.0	-26.2	0.1	-173.8	-173.8
2.5	0.1	31.4	-18.8	3.1	-3.9	9.9	0.1	-54.1	-25.7	0.1	-159.1	-159.1
2.6	0.1	5.3	-22.8	3.1	-14.3	9.8	0.1	-63.0	-25.4	0.2	-150.2	-150.2
2.7	0.0	-52.7	-26.1	3.0	-24.9	9.6	0.1	-72.6	-25.1	0.2	-146.2	-146.2
2.8	0.1	-107.7	-22.3	3.0	-35.7	9.4	0.1	-81.5	-25.2	0.3	-146.1	-146.1
2.9	0.1	-133.0	-18.1	2.9	-46.6	9.1	0.1	-91.5	-25.0	0.3	-148.8	-148.8
3.0	0.2	-148.7	-15.3	2.7	-57.4	8.7	0.1	-101.4	-25.1	0.4	-152.6	-152.6
3.5	0.3	163.0	-10.5	1.9	-106.7	5.7	0.0	-145.3	-26.8	0.5	-174.2	-174.2
4.0	0.2	128.4	-13.3	1.3	-147.2	2.4	0.0	177.4	-29.2	0.5	171.9	171.9
5.0	0.3	-82.7	-9.8	0.6	130.4	-4.4	0.0	92.7	-35.1	0.5	162.6	162.6
6.0	0.7	-128.5	-3.0	0.3	111.6	-11.3	0.0	51.4	-41.4	0.5	156.3	156.3
7.0	0.7	-164.9	-3.1	0.2	31.6	-14.6	0.0	-63.3	-39.0	0.5	135.7	135.7
8.0	0.3	-158.9	-9.8	0.1	-78.9	-20.1	0.0	-163.6	-34.8	0.6	106.4	106.4
9.0	0.7	173.3	-2.5	0.0	117.6	-38.8	0.0	103.9	-42.1	0.6	95.6	95.6
10.0	0.9	149.3	-0.8	0.0	-6.6	-57.1	0.0	147.9	-63.8	0.6	92.9	92.9
11.0	0.8	144.2	-1.9	0.0	-157.7	-60.1	0.0	142.8	-50.3	0.6	84.1	84.1
12.0	0.8	137.6	-2.5	0.0	58.4	-60.9	0.0	100.4	-54.5	0.5	59.0	59.0
13.0	0.7	116.8	-3.4	0.0	98.8	-62.4	0.0	90.8	-54.5	0.6	29.1	29.1
14.0	0.7	96.2	-3.7	0.0	33.1	-60.1	0.0	75.9	-55.7	0.6	12.9	12.9
15.0	0.6	85.0	-3.9	0.0	-26.7	-54.0	0.0	-21.8	-53.0	0.6	6.9	6.9
16.0	0.6	78.2	-4.6	0.0	-44.2	-61.6	0.0	-58.2	-59.0	0.6	2.8	2.8
17.0	0.5	69.0	-5.6	0.0	-86.2	-58.6	0.0	-65.1	-56.5	0.6	-9.2	-9.2
18.0	0.4	52.2	-7.6	0.0	-108.8	-62.6	0.0	-83.8	-67.1	0.5	-32.3	-32.3
19.0	0.3	21.3	-11.2	0.0	-40.8	-60.3	0.0	-37.8	-66.4	0.6	-53.9	-53.9
20.0	0.1	-34.6	-20.4	0.0	-71.8	-47.2	0.0	-63.0	-48.0	0.6	-67.4	-67.4

TRL Board Layer:    Top Metal        → 0.5 oz CU  
                              Rogers RO4350    → 0.01"  
                              Inner Metal        → 0.5 oz CU  
                              Bottom Metal      → 0.5 oz CU

### ALM-80210 K-Factor

$T_c = 25^\circ\text{C}$ ,  $V_{dd} = 5.0\text{V}$ ,  $V_{ctrl} = 5\text{V}$ ,  $V_{bias} = 4.0\text{V}$ ,  $Z_o = 50\Omega$

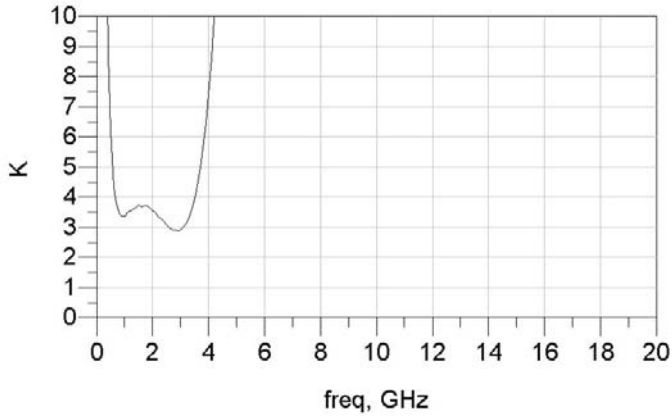

### ALM-80210 Typical Noise Parameters

$T_c = 25^\circ\text{C}$ ,  $V_{dd} = 5.0\text{V}$ ,  $V_{ctrl} = 5\text{V}$ ,  $V_{bias} = 4.0\text{V}$ ,  $Z_o = 50\Omega$

Freq (GHz)	F <sub>MIN</sub> (dB)	$\Gamma_{opt}$		R <sub>n</sub> /Z <sub>o</sub> 500hm	Ga (dB)
		Mag	Ang		
0.5	10.51	0.872	-152	2.52	6.99
1	5.89	0.728	-119	1.652	13.69
1.3	4.96	0.611	-92.7	1.43	12.09
1.5	4.64	0.478	-74.2	1.282	11.37
1.6	4.62	0.415	-64.7	1.22	11.03
1.7	4.66	0.352	-55.9	1.148	10.77
1.8	4.69	0.298	-45.7	1.088	10.52
1.9	4.75	0.238	-36.7	1.032	10.35
2	5.03	0.178	-25.9	1	10.21
2.1	5.21	0.125	-14.9	0.952	10.13
2.2	5.27	0.083	0.3	0.918	10.06
2.3	5.49	0.054	-25.9	0.862	10.06
2.4	5.63	0.043	98.9	0.818	9.93
2.5	5.79	0.061	130.4	0.812	9.89
2.6	5.93	0.097	156.4	0.748	9.83
2.7	6.21	0.107	163.3	0.798	9.78
2.8	6.38	0.134	170.5	0.792	9.7
2.9	6.61	0.172	-169.3	1.188	9.51
3	6.83	0.216	-161.7	0.828	9.26
3.5	7.64	0.21	-157.3	1.03	7.39
4	9.28	0.167	-146.5	1.87	4.14
4.5	10.95	0.033	77.2	3.28	0.69
5	13.86	0.272	88.4	7.552	-2.87
6	16.2	0.701	127.9	13.176	-6.91

## PCB Layout and Stencil Design

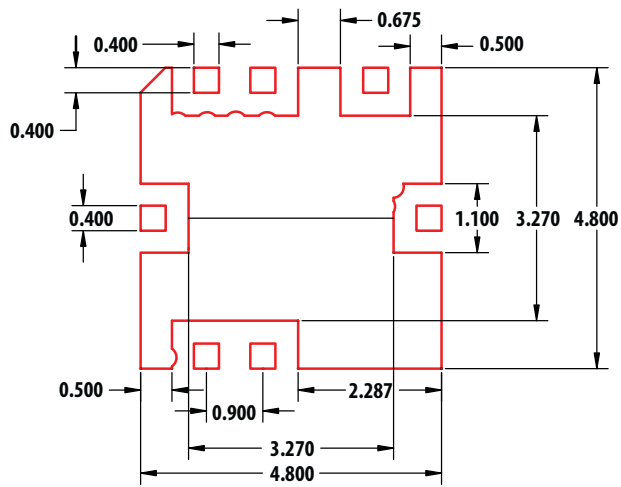

PCB Land Pattern (Top View)

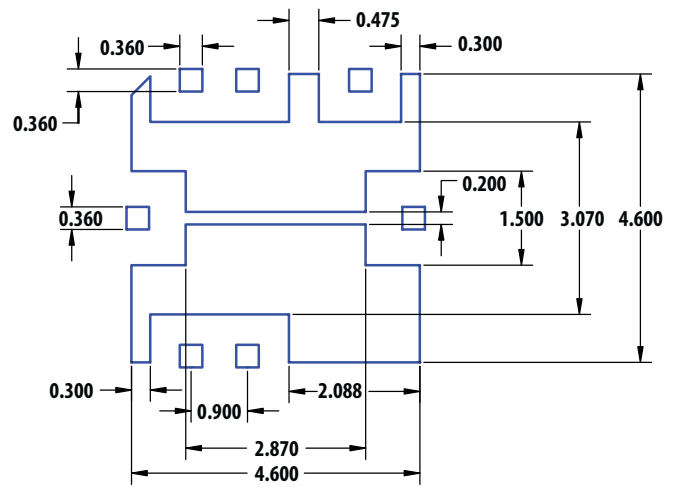

Stencil Outline

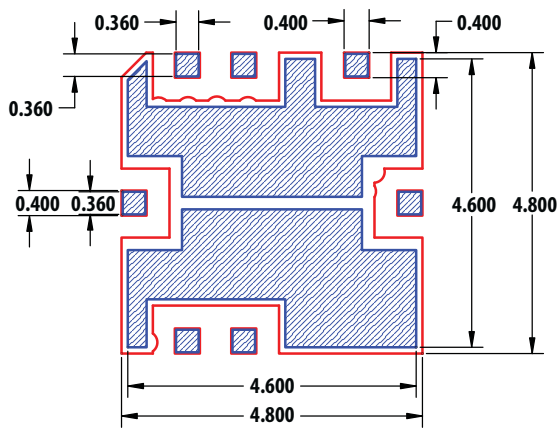

Combined PCB & Stencil Layouts

All Dimension are in MM

## Package Dimension

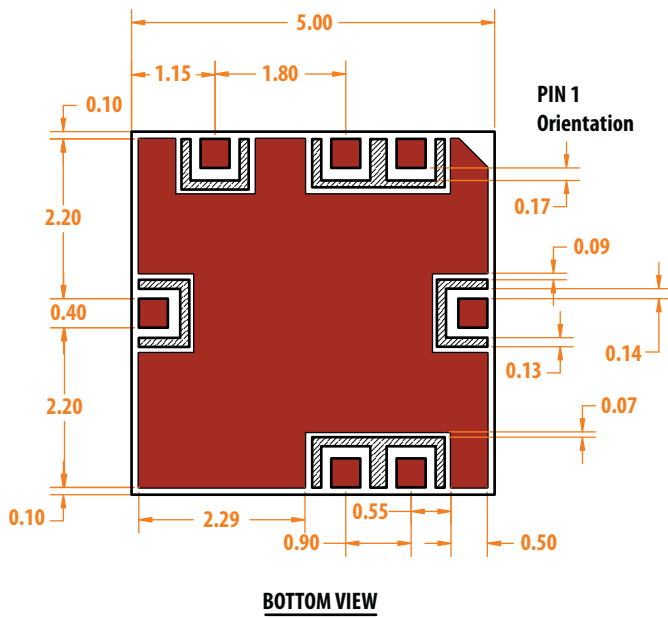
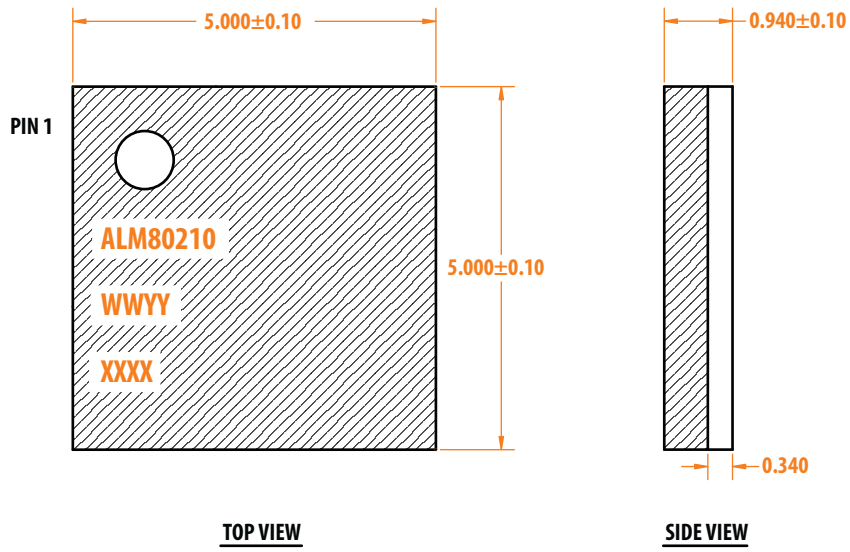

Note :

1. All dimensions are in millimeters
2. Dimensions are inclusive of plating
3. Dimensions are exclusive of mold flash and metal burr.



## Device Orientation

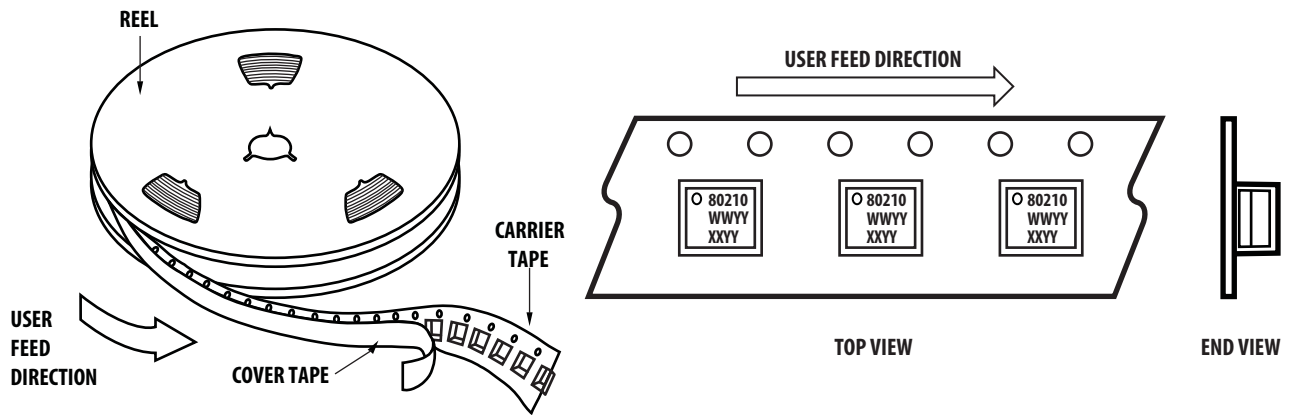

## Tape Dimensions

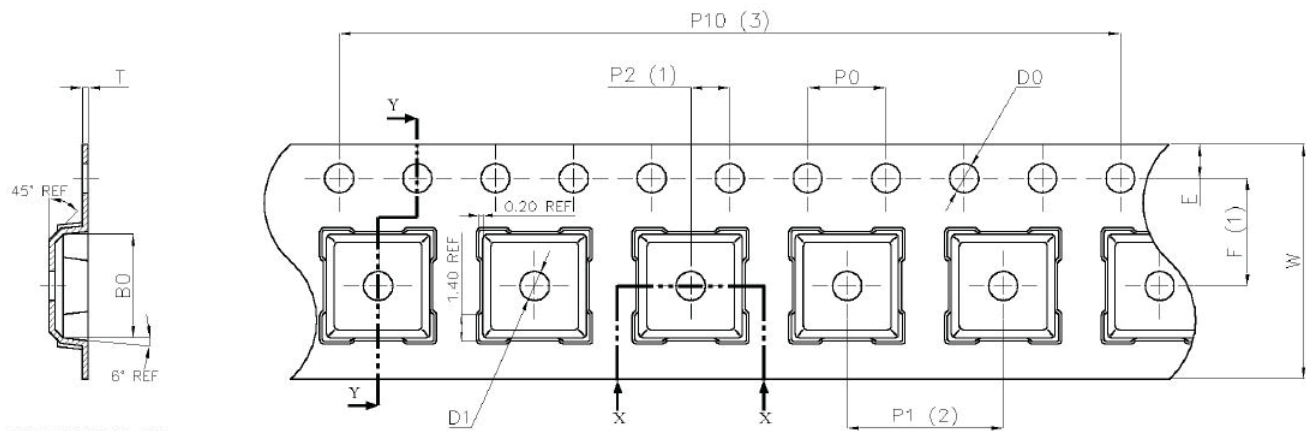

SECTION Y - Y

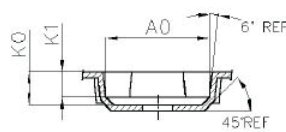

SECTION X - X

Dimension List			
Annote	Millimeter	Annote	Millimeter
A0	5.40±0.10	P0	4.00±0.10
B0	5.40±0.10	P2	2.00±0.10
D0	1.50 <sup>+0.10</sup> <sub>-0</sub>	P10	40.00±0.20
D1	1.60±0.10	E	1.75±0.10
K0	1.90±0.10	F	5.50±0.10
K1	1.50±0.10	T	0.30±0.03
P1	8.00±0.10	W	12.00±0.30

## Part Ordering Information

Part Number	No. of Devices	Container
ALM-80210-BLKG	100	Antistatic Bag
ALM-80210-TR1G	3000	13" Reel

For product information and a complete list of distributors, please go to our web site: [www.avagotech.com](http://www.avagotech.com)

Avago, Avago Technologies, and the A logo are trademarks of Avago Technologies in the United States and other countries. Data subject to change. Copyright © 2005-2010 Avago Technologies. All rights reserved.  
AV02-1971EN - March 29, 2010



## X-ON Electronics

Largest Supplier of Electrical and Electronic Components

*Click to view similar products for [RF Amplifier](#) category:*

*Click to view products by [Broadcom](#) manufacturer:*

Other Similar products are found below :

[A82-1](#) [BGA622H6820XTSA1](#) [BGA 728L7 E6327](#) [BGB719N7ESDE6327XTMA1](#) [HMC397-SX](#) [HMC405](#) [HMC561-SX](#) [HMC8120-SX](#)  
[HMC8121-SX](#) [HMC-ALH382-SX](#) [HMC-ALH476-SX](#) [SE2433T-R](#) [SMA3101-TL-E](#) [SMA39](#) [A66-1](#) [A66-3](#) [A67-1](#) [A81-2](#) [LX5535LQ](#)  
[LX5540LL](#) [MAAM02350](#) [HMC3653LP3BETR](#) [HMC549MS8GETR](#) [HMC576-SX](#) [HMC-ALH435-SX](#) [SMA101](#) [SMA32](#) [SMA411](#)  
[SMA531](#) [SST12LP19E-QX6E](#) [WPM0510A](#) [HMC5879LS7TR](#) [HMC1087F10](#) [HMC1086](#) [HMC1016](#) [SMA1212](#) [MAX2689EWS+T](#)  
[MAAMSS0041TR](#) [MAAM37000-A1G](#) [LTC6430AIUF-15#PBF](#) [SMA70-2](#) [SMA4011](#) [A231](#) [HMC-AUH232](#) [LX5511LQ](#) [LX5511LQ-TR](#)  
[HMC7441-SX](#) [HMC-ALH310](#) [XD1001-BD-000V](#) [A4011](#)