

Data Sheet

Description

The Broadcom[®] ALMD-Lx38 Oval LED series has the same or just slightly less luminous intensity than conventional high brightness through holes LEDs.

The new Oval LED lamps can be assembled using common SMT assembly processes and are compatible with industrial reflow soldering processes.

The LEDs are made with an advanced optical grade epoxy for superior performance in outdoor sign applications. The surface mount Oval LEDs are specifically designed for full color/video signs and indoor or outdoor passenger information sign applications.

For easy pick and place assembly, the LEDs are shipped in tape and reel. Every reel is shipped from a single intensity and color bin for better uniformity.

Features

- Well defined spatial radiation pattern
- High brightness material
- Available in Green and Blue LED
 - Green InGaN 525 nm
 - Blue InGaN 470 nm
- JEDEC MSL 2A
- Compatible with the reflow soldering process
- Tinted and diffused lens
- Wide viewing angle: 40° × 100°

Applications

- Mono color signs

CAUTION	InGaN devices are Class 1C HBM ESD sensitive, AlInGaP devices are Class 1B ESD sensitive per JEDEC Standard. Please observe appropriate precautions during handling and processing. Refer to Application Note AN-1142 for additional details. Customers should always keep the LED in the moisture barrier bag (MBB) with <5% RH when not in use because prolonged exposure to the environment might cause the leads to tarnish or rust, which might cause difficulties in soldering.
----------------	--

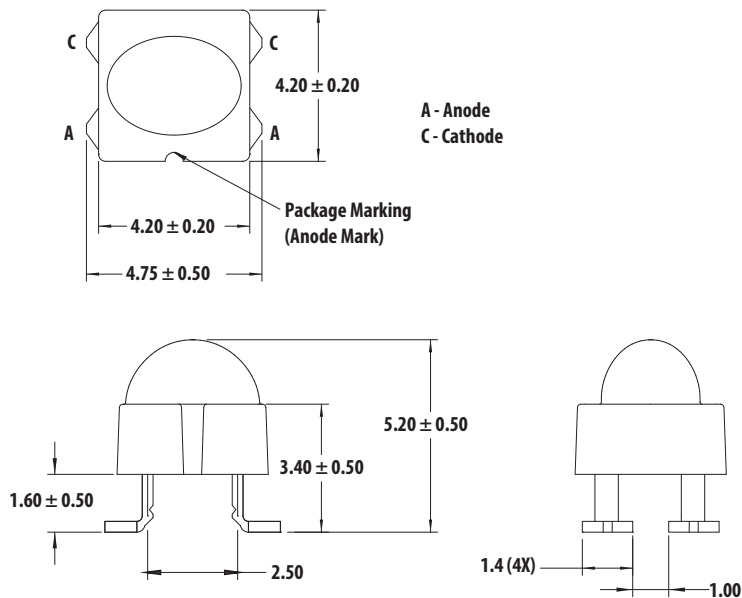
Figure 1 Package Dimensions**NOTE**

1. All dimensions in millimeters (mm).
2. Tolerance is ± 0.20 mm, unless other specified.
3. Midsteel lead frame.

Device Selection Guide

Part Number	Color and Dominant Wavelength, λ_d (nm) ^a	Luminous Intensity, I_V (mcd) ^{b,c,d}		Viewing Angle, $2\theta_{1/2}$ (°) ^e
	Typ.	Min.	Max.	Typ.
ALMD-LM38-24002	Green 525	3500	6050	40 × 100
ALMD-LB38-TV002	Blue 470	800	1380	40 × 100

- a. Dominant wavelength, λ_d , is derived from the CIE Chromaticity Diagram and represents the color of the lamp.
- b. The luminous intensity is measured on the mechanical axis of the lamp package and it is tested with pulsing condition.
- c. The optical axis is closely aligned with the package mechanical axis.
- d. Tolerance for each bin limit is $\pm 15\%$.
- e. $\theta_{1/2}$ is the off-axis angle where the luminous intensity is half of the peak intensity.

Absolute Maximum Rating, $T_J = 25^\circ\text{C}$

Parameter	Green	Blue	Unit
DC Forward Current ^a	30	20	mA
Peak Forward Current ^b	100	100	mA
Power Dissipation	114	70	mW
LED Junction Temperature	110	105	$^\circ\text{C}$
Operating Temperature Range	-40 to +85		$^\circ\text{C}$
Storage Temperature Range	-40 to +100		$^\circ\text{C}$

a. Derate linearly as shown in Figure 5.

b. Duty Factor = 10%, frequency = 1 kHz.

Electrical/Optical Characteristics, $T_J = 25^\circ\text{C}$

Parameter	Symbol	Min.	Typ.	Max.	Unit	Test Conditions
Forward Voltage	V_F				V	$I_F = 20\text{ mA}$.
Green		2.5	2.8	3.8		
Blue		2.5	2.8	3.5		
Reverse Voltage ^a	V_R				V	$I_R = 10\ \mu\text{A}$.
Green		5	—	—		
Blue		5	—	—		
Dominant Wavelength ^b	λ_d				nm	$I_F = 20\text{ mA}$.
Green		519	525	539		
Blue		460	470	480		
Peak Wavelength	λ_{PEAK}				nm	Peak of Wavelength of Spectral Distribution at $I_F = 20\text{ mA}$.
Green		—	522	—		
Blue		—	464	—		
Thermal Resistance	$R\theta_{\text{J-PIN}}$				$^\circ\text{C/W}$	LED Junction-to-Pin.
Green		—	270	—		
Blue		—	480	—		
Luminous Efficacy ^c	η_V				lm/W	Emitted Luminous Power/Emitted Radiant Power.
Green		—	500	—		
Blue		—	85	—		
Thermal Coefficient of λ_d					nm/ $^\circ\text{C}$	$I_F = 20\text{ mA}$; $+25^\circ\text{C} \leq T_J \leq +100^\circ\text{C}$.
Green		—	0.033	—		
Blue		—	0.033	—		

a. Indicates product final testing condition. Long-term reverse bias is not recommended.

b. The dominant wavelength is derived from the Chromaticity Diagram and represents the color of the lamp.

c. The radiant intensity, I_e in watts per steradian, may be found from the equation $I_e = I_V/\eta_V$ where I_V is the luminous intensity in candelas and η_V is the luminous efficacy in lumens/watt.

Part Numbering System

A L M D -

x ₁	x ₂	x ₃	x ₄
----------------	----------------	----------------	----------------

 -

x ₅	x ₆	x ₇	x ₈	x ₉
----------------	----------------	----------------	----------------	----------------

Code	Description	Option
x ₁	Package type	L Oval AlInGaP/InGaN
x ₂	Color	B Blue
		M Green
x ₃ , x ₄	Viewing Angle	38 40° × 100°
x ₅	Minimum Intensity Bin	Refer to Intensity Bin Limit Table (1.2:1 I_v Bin Ratio) .
x ₆	Maximum Intensity Bin	
x ₇	Color Bin Selection	0 Full distribution
x ₈ , x ₉	Packaging Option	02 Tested 20 mA, 13-inch carrier tape

Bin Information

Intensity Bin Limit Table (1.2:1 I_v Bin Ratio)

Bin	Luminous Intensity, I _v (mcd) at 20 mA	
	Min.	Max.
T	800	960
U	960	1150
V	1150	1380
W	1380	1660
X	1660	1990
Y	1990	2400
Z	2400	2900
1	2900	3500
2	3500	4200
3	4200	5040
4	5040	6050

Tolerance for each bin limit is ±15%.

Green Color Range

Bin	Min. Dom.	Max. Dom.	X Min.	Y Min.	X Max.	Y Max.
1	519.0	523.0	0.0667	0.8323	0.1450	0.7319
			0.1200	0.7375	0.0979	0.8316
2	523.0	527.0	0.0979	0.8316	0.1711	0.7218
			0.1450	0.7319	0.1305	0.8189
3	527.0	531.0	0.1305	0.8189	0.1967	0.7077
			0.1711	0.7218	0.1625	0.8012
4	531.0	535.0	0.1625	0.8012	0.2210	0.6920
			0.1967	0.7077	0.1929	0.7816
5	535.0	539.0	0.1929	0.7816	0.2445	0.6747
			0.2210	0.6920	0.2233	0.7600

Tolerance for each bin limit is ±0.5 nm.

Blue Color Range

Bin	Min. Dom.	Max. Dom.	X Min.	Y Min.	X Max.	Y Max.
1	460.0	464.0	0.1440	0.0297	0.1766	0.0966
			0.1818	0.0904	0.1374	0.0374
2	464.0	468.0	0.1374	0.0374	0.1699	0.1062
			0.1766	0.0966	0.1291	0.0495
3	468.0	472.0	0.1291	0.0495	0.1616	0.1209
			0.1699	0.1062	0.1187	0.0671
4	472.0	476.0	0.1187	0.0671	0.1517	0.1423
			0.1616	0.1209	0.1063	0.0945
5	476.0	480.0	0.1063	0.0945	0.1397	0.1728
			0.1517	0.1423	0.0913	0.1327

Tolerance for each bin limit is ±0.5 nm.

Figure 2 Relative Intensity vs. Wavelength

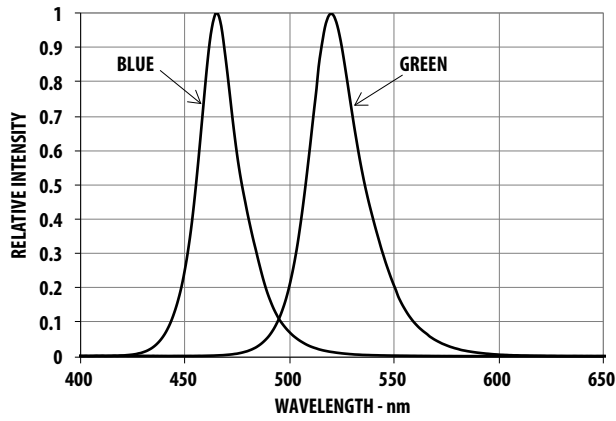

Figure 3 Forward Current vs. Forward Voltage

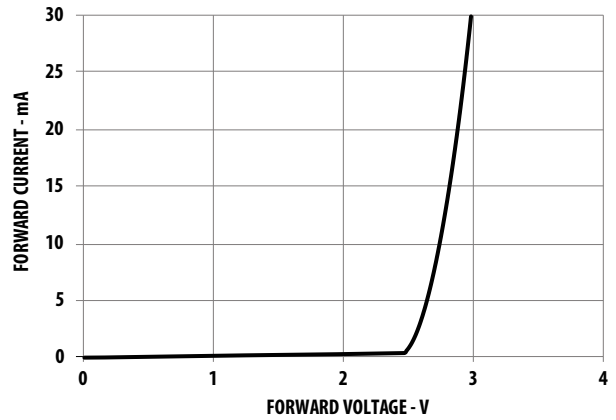

Figure 4 Relative Intensity vs. Forward Current

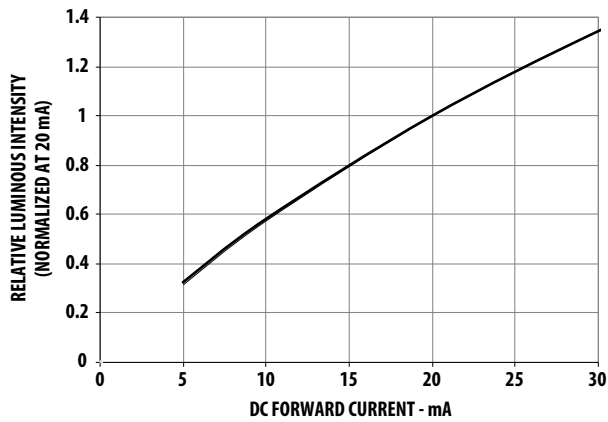

Figure 5 Maximum Forward Current vs. Ambient Temperature

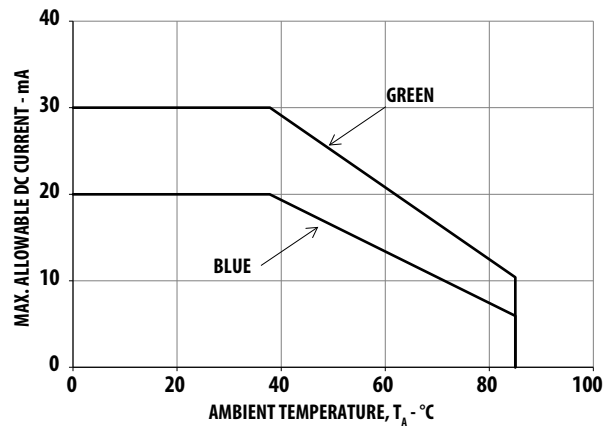

Figure 6 Dominant Wavelength Shift vs. Forward Current

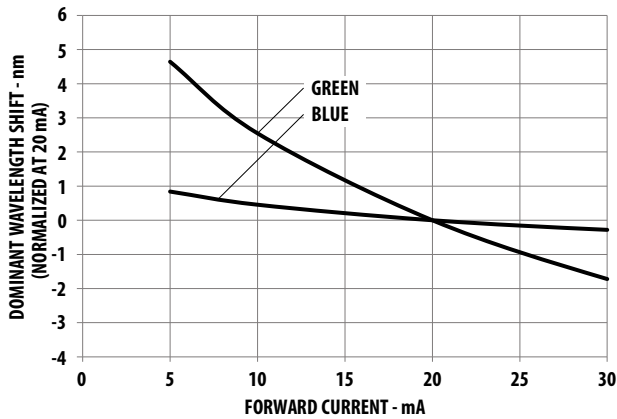

Figure 7 Radiation Pattern for Major Axis

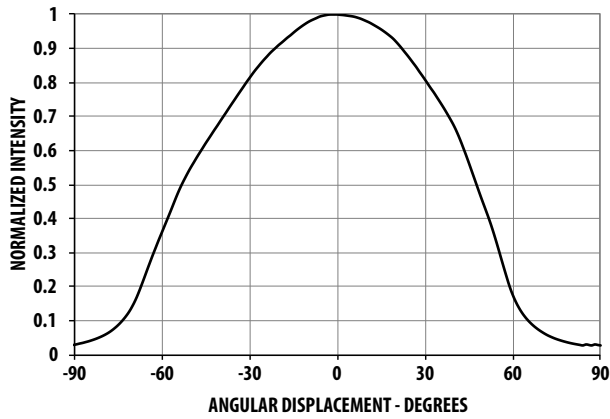

Figure 8 Radiation Pattern for Minor Axis

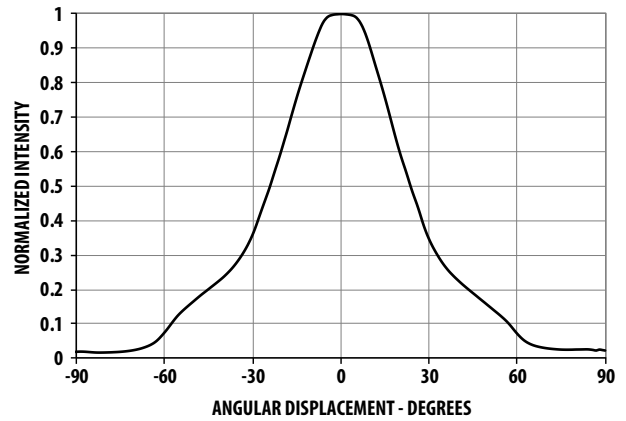

Figure 9 Relative Light Output vs. Junction Temperature

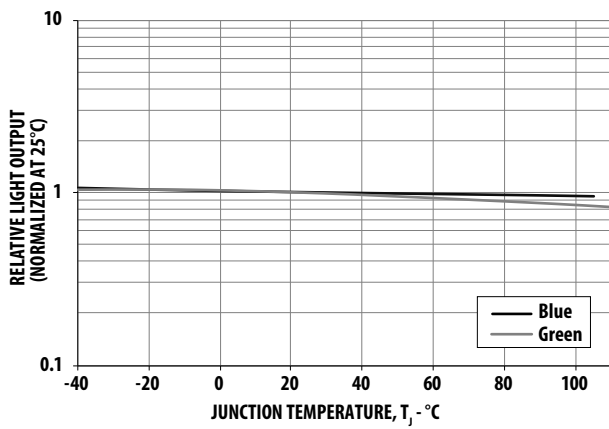

Figure 10 Forward Voltage Shift vs. Junction Temperature

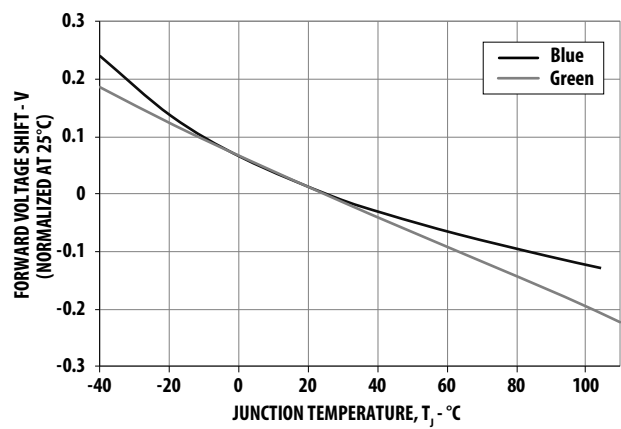
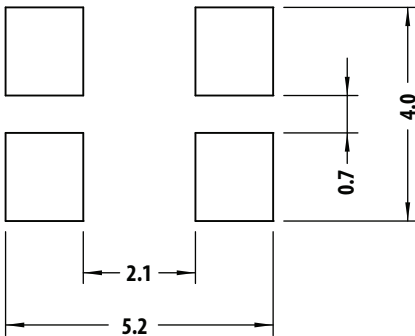

Figure 11 Recommended Soldering Land Pattern



NOTE Recommended stencil thickness is 0.1524 mm (6 mils) minimum and above.

Figure 12 Carrier Tape Dimension

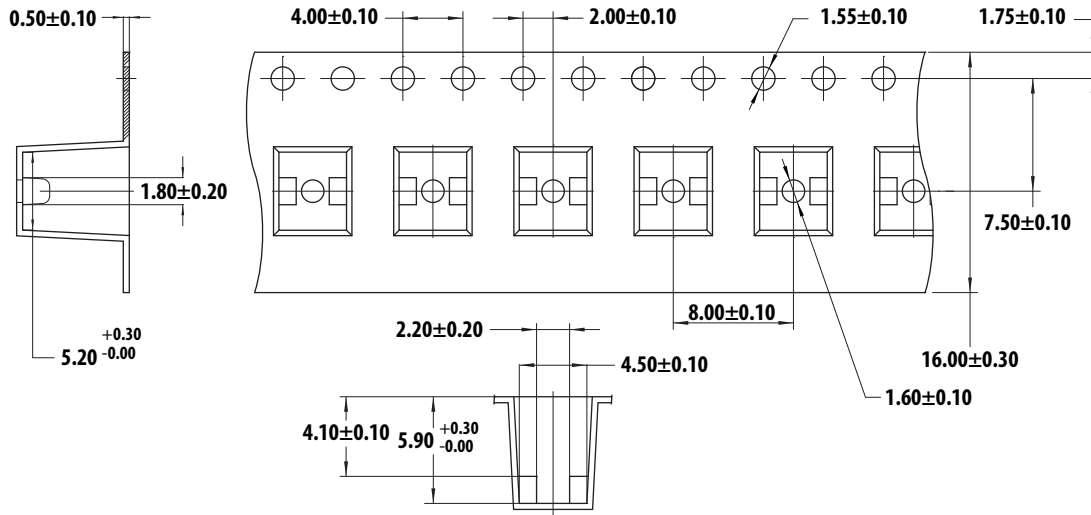
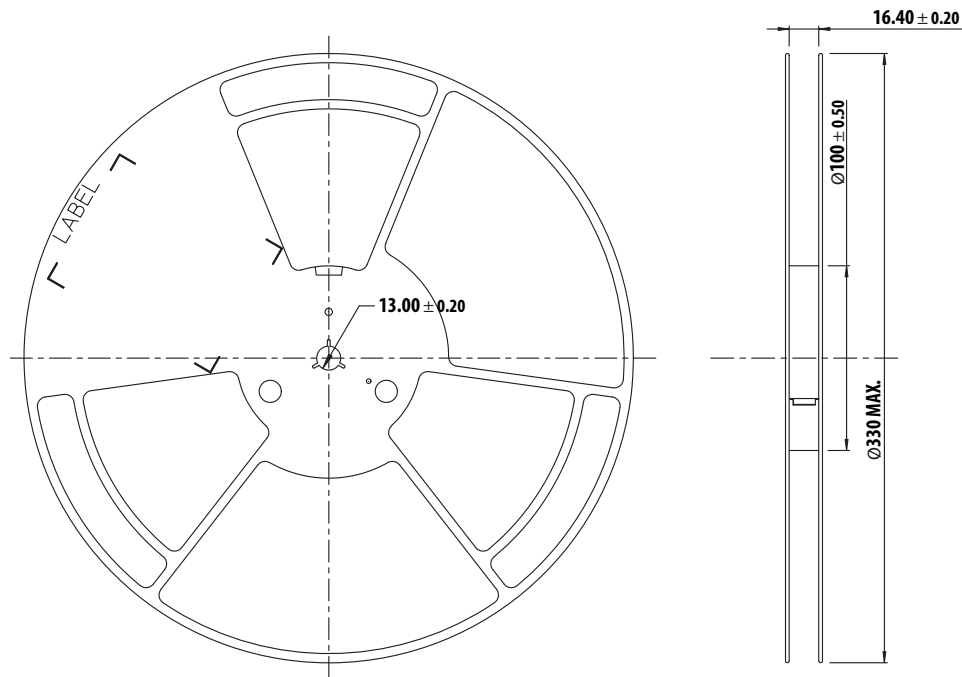
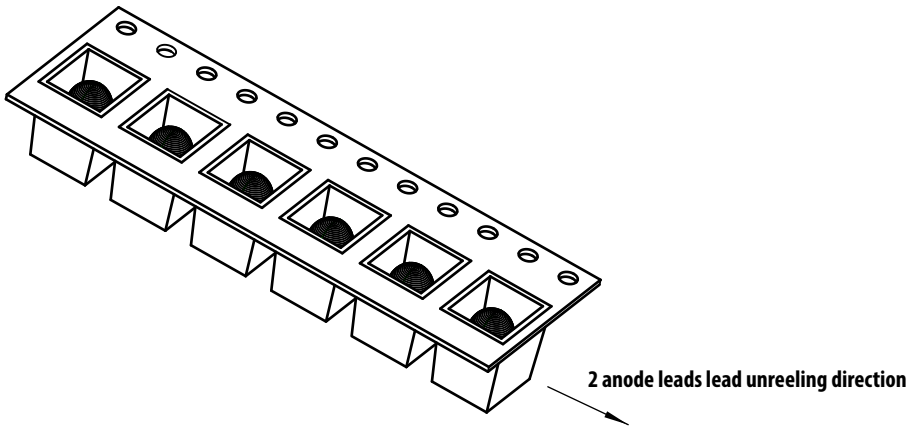

Figure 13 Reel Dimension















NOTE All dimensions are in millimeters.

Figure 14 Unit Orientation from Reel









Packing Label

(i) Mother Label (Available on the MBB Bag)

<p>(1P) Item: Part Number </p> <p>(1T) Lot: Lot Number </p> <p>LPN: </p> <p>(9D)MFG Date: Manufacturing Date </p>		<p>AVAGO TECHNOLOGIES</p> <p>STANDARD LABEL LS0002 RoHS Compliant (Q) QTY: Quantity e4 Max Temp 260C MSL 2a </p> <p>CAT: Intensity Bin </p> <p>BIN: Refer to below information </p>	
<p>(P) Customer Item: </p>			
<p>(V) Vendor ID: </p>		<p>(9D) Date Code: Date Code </p>	
<p>DeptID: OEAT01 </p>		<p>Made In: Country of Origin </p>	

(ii) Baby Label (Available on the Plastic Reel)

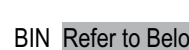
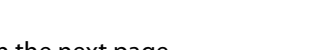
<p>(1P) PART #: Part Number </p> <p>(1T) Lot #: Lot Number </p> <p>(9D)MFG Date: Manufacturing Date </p> <p>C/O: Country of Origin </p> <p>(1T) TAPE DATE: Taping Date </p>		<p>AVAGO TECHNOLOGIES</p> <p>BABY LABEL COSBOO1B V0.0</p> <p>(Q) QTY: Quantity </p> <p>(9D) Date Code: Date Code </p> <p>CAT Intensity Bin </p> <p>BIN Refer to Below information </p>	
---	--	---	--

For definitions, see [Acronyms and Definitions](#) on the next page.

Acronyms and Definitions

BIN:

(i) Color bin only or V_F bin only

(Applicable for part numbers with color bins but without a V_F bin or part numbers with V_F bins and no color bin)

(ii) Color bin incorporated with V_F bin

Applicable for part numbers that have both the color bin and the V_F bin

Example:

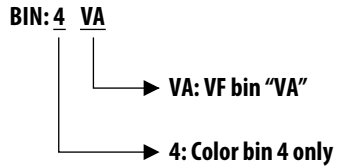

- a. Color bin only or V_F bin only
 - BIN: 4 (represent color bin 4 only)
 - BIN: VA (represent V_F bin "VA" only)
- b. Color bin incorporates with the V_F bin

Precautionary Notes

Soldering

- Reflow soldering must not be done more than two times. Take the necessary precautions for handling a moisture-sensitive device, as stated in [Handling Precautions](#).
- Do not apply any pressure or force on the LED during reflow and after reflow when the LED is still hot.
- Use reflow soldering to solder the LED. Use hand soldering only for rework if unavoidable, but hand soldering must be strictly controlled to the following conditions:
 - Soldering iron tip temperature = 320°C maximum.
 - Soldering duration = 3 sec maximum.
 - Number of cycles = 1 only
 - Power of soldering iron = 50W maximum.
- Do not touch the LED body with a hot soldering iron except the soldering terminals because this might damage the LED.
- For de-soldering, use a double head soldering iron.
- Confirm beforehand whether the functionality and performance of the LED is affected by hand soldering.

Figure 15 Leaded Reflow Soldering

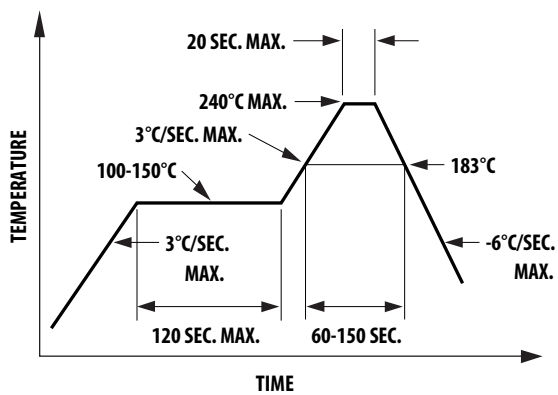

Figure 16 Lead-Free Reflow Soldering

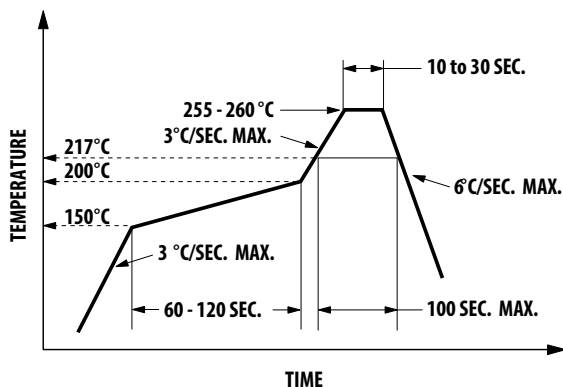
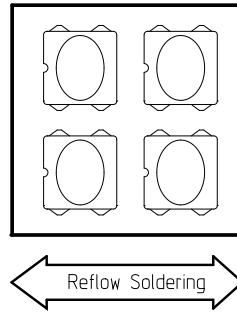

Figure 17 Recommended Board Reflow Direction



Handling Precautions

For automated pick and place, Broadcom has tested the following nozzle size made with urethane material to work well with this LED. However, due to the possibility of variations in other parameters, such as pick and place, machine maker/model, and other settings of the machine, verify the selected nozzle.

Figure 18 Nozzle Diagram

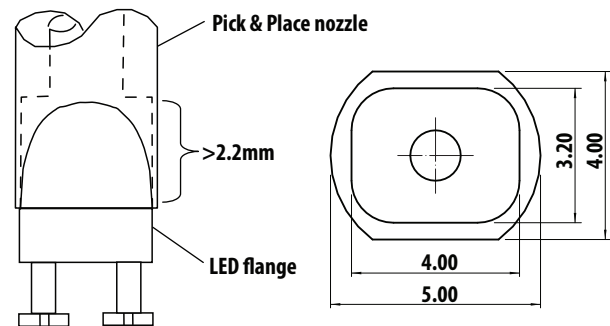

NOTE The nozzle tip should touch the LED flange during pick and place.

The outer dimensions of the nozzle should fit into the carrier tape pocket.

Handling of Moisture-Sensitive Device

This product has a Moisture Sensitive Level 2a rating per JEDEC J-STD-020. Refer to Broadcom Application Note AN5305, *Handling of Moisture Sensitive Surface Mount Devices*, for additional details and a review of proper handling procedures.

- Before use:
 - An unopened moisture barrier bag (MBB) can be stored at <math> < 40^{\circ}\text{C}/90\% \text{ RH}</math> for 12 months. If the actual shelf life has exceeded 12 months and the humidity indicator card (HIC) indicates that baking is not required, then it is safe to reflow the LEDs per the original MSL rating.
 - Do not open the MBB prior to assembly (e.g., for IQC).
- Control after opening the MBB:
 - Read the humidity indicator card (HIC) immediately upon opening of MBB.
 - Keep the LEDs <math> < 30^{\circ}\text{C}/60\% \text{ RH}</math> at all times; all high-temperature-related processes, including soldering, curing, or rework, must be completed within 672 hours.
- Control for unfinished reel:
 - Store unused LEDs in a sealed MBB with desiccant or desiccator at <math> < 5\% \text{ RH}</math>.
- Control of assembled boards:
 - If the PCB soldered with the LEDs is to be subjected to other high-temperature processes, store the PCB in a sealed MBB with desiccant or desiccator at <math> < 5\% \text{ RH}</math> to ensure that all LEDs have not exceeded their floor life of 672 hours.
- Baking is required if:
 - The HIC indicator is not BROWN at 10% and is AZURE at 5%.
 - The LEDs are exposed to conditions of $> 30^{\circ}\text{C}/60\% \text{ RH}$ at any time.
 - The LED floor life exceeded 672 hours.

The recommended baking condition is: $60^{\circ}\text{C} \pm 5^{\circ}\text{C}$ for 20 hours. Baking should only be done once.
- Storage:
 - The soldering terminals of these Broadcom LEDs are silver plated. If the LEDs are exposed for too long in an ambient environment, the silver plating might become oxidized, thus affecting its solderability performance. As such, keep unused LEDs in a sealed MBB with desiccant or in desiccator at <math> < 5\% \text{ RH}</math>.

Application Precautions

- The drive current of the LED must not exceed the maximum allowable limit across temperature as stated in the data sheet. Constant current driving is recommended to ensure consistent performance.
- LEDs exhibit slightly different characteristics at different drive currents, which might result in larger performance variations (i.e., intensity, wavelength, and forward voltage). Set the application current as close as possible to the test current to minimize these variations.
- The LED is not intended for reverse bias. Use other appropriate components for such purposes. When driving the LED in matrix form, make sure that the reverse bias voltage does not exceed the allowable limit of the LED.
- Avoid rapid changes in ambient temperature, especially in high-humidity environments, because this will cause condensation on the LED.
- If the LED is intended to be used in outdoor or harsh environments, protect the LED leads with suitable potting material against damages caused by rain water, oil, corrosive gases, and so on. Use a louver or shade to reduce direct sunlight on the LEDs.

Eye Safety Precautions

LEDs might pose optical hazards when in operation. Do not look directly at operating LEDs because it might be harmful to the eyes. For safety reasons, use appropriate shielding or personal protective equipment.

Disclaimer:

Broadcom's products and software are not specifically designed, manufactured, or authorized for sale as parts, components, or assemblies for the planning, construction, maintenance, or direct operation of a nuclear facility or for use in medical devices or applications. The customer is solely responsible, and waives all rights to make claims against Broadcom or its suppliers, for all loss, damage, expense, or liability in connection with such use.

For product information and a complete list of distributors, please go to our web site: www.broadcom.com.

Broadcom, the pulse logo, Connecting everything, Avago Technologies, Avago, and the A logo are among the trademarks of Broadcom in the United States, certain other countries and/or the EU.

Copyright © 2015-2017 Broadcom. All Rights Reserved.

The term "Broadcom" refers to Broadcom Limited and/or its subsidiaries. For more information, please visit www.broadcom.com.

Broadcom reserves the right to make changes without further notice to any products or data herein to improve reliability, function, or design.

Information furnished by Broadcom is believed to be accurate and reliable. However, Broadcom does not assume any liability arising out of the application or use of this information, nor the application or use of any product or circuit described herein, neither does it convey any license under its patent rights nor the rights of others.

AV02-4619EN – May 18, 2017



X-ON Electronics

Largest Supplier of Electrical and Electronic Components

Click to view similar products for [Standard LEDs - SMD category](#):

Click to view products by [Broadcom manufacturer](#):

Other Similar products are found below :

[LTST-C19GD2WT](#) [LTST-N683GBEW](#) [LTW-170ZDC](#) [LTW-M140SZS40](#) [598-8110-100F](#) [598-8170-100F](#) [598-8610-202F](#) [67-22VRVGC/TR8](#) [AAAF5060QBFSEEZGS](#) [HLMP-6305-L0011](#) [ALMD-LB36-SV002](#) [APT1608QGW](#) [15-21UYC/S530-A3/TR8](#) [EASV1803BA0](#) [LG M67K-H1J2-24-0-2-R18-Z](#) [LS A676-P2S1-1](#) [SML-512VWT86A](#) [SML-LX0606SISUGC/A](#) [SML-LXL1307SRC-TR](#) [SML-LXR851SIUPGUBC](#) [LT1ED53A](#) [FAT801-S](#) [AM27ZGC03](#) [APB3025SGNC](#) [APFA3010SURKCGKQBDC](#) [APHK1608VGCA](#) [APT2012QGW](#) [CLX6D-FKB-CN1R1H1BB7D3D3](#) [LTST-C250KGKT](#) [LTW-020ZDCG](#) [LTW-21TS5](#) [LTW-220DS5](#) [JANTXM19500/521-02](#) [UYGT801-S](#) [42-21UYC/S530-A3/TR8](#) [LO T67F-V1AB-24-1](#) [YGFR411-H](#) [SML-LX0402IC-TR](#) [CMDA20AYAA7D1S](#) [CMDA16AYDR7A1X](#) [339-1SURYGW/S530-A2](#) [598-8040-100F](#) [598-8070-100F](#) [598-8140-100F](#) [598-8610-200F](#) [EAPL3527GA5](#) [67-11/BHC-M1N2B8Y/2A0](#) [SML-LXL1209SYC/ATR](#) [EASV3020YGA0](#) [EAST16086YA5](#)