

AMMP-6425

18-28 GHz 1W Power Amplifier in SMT Package

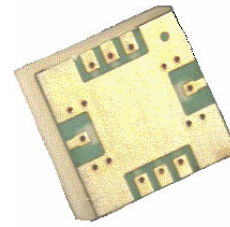

Data Sheet



Description

The AMMP-6425 MMIC is a broadband 1W power amplifier in a surface mount package designed for use in transmitters that operate in various frequency bands between 18GHz and 28GHz. At 25GHz, it provides 31dBm of output power (P-1dB) and 25dB of small-signal gain from a small easy-to-use device. The device has input and output matching circuitry for use in 50Ω environments. The AMMP-6425 also integrates a temperature compensated RF power detection circuit that enables power detection of 0.25V/W. DC bias is simple and the device operates on widely available 5V for current supply (negative voltage only needed for Vg). It is fabricated in a PHEMT process for exceptional power and gain performance.

Package Diagram

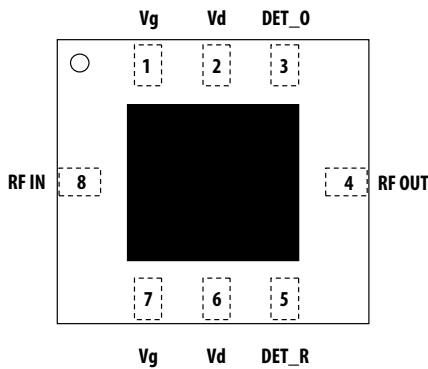

Note:

- This MMIC uses depletion mode pHEMT devices. Negative supply is used for DC gate biasing.

Features

- 5x5 mm Surface Mount Package
- Wide Frequency Range 18-28GHz
- One watt output power
- 50 Ω match on input and output

Specifications (Vd=5V, Idq=650mA)

- Frequency range 18 to 28 GHz
- Small signal Gain of 22dB
- Output power @P-1 of 28dBm (Typ.)
- Input/Output return-loss of -12dB

Applications

- Microwave Radio systems
- Satellite VSAT, DBS Up/Down Link
- LMDS & Pt-Pt mmW Long Haul
- Broadband Wireless Access (including 802.16 and 802.20 WiMax)
- WLL and MMDS loops
- Commercial grade military

Functional Block Diagram

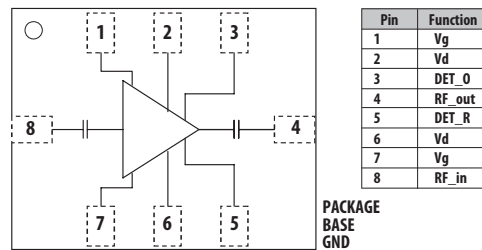

Attention: Observe Precautions for handling electrostatic sensitive devices.

ESD Machine Model (Class A): 60V
ESD Human Body Model (Class 0): 200V
Refer to Avago Application Note A004R:
Electrostatic Discharge Damage and Control.

Note: MSL Rating = Level 2A

Electrical Specifications

1. Small/Large -signal data measured in a fully de-embedded test fixture form TA = 25°C.
2. Pre-assembly into package performance verified 100% on-wafer per AMMC-6425 published specifications.
3. This final package part performance is verified by a functional test correlated to actual performance at one or more frequencies.
4. Specifications are derived from measurements in a 50 Ω test environment. Aspects of the amplifier performance may be improved over a more narrow bandwidth by application of additional conjugate, linearity, or low noise (Γopt) matching.
5. The Gain and P1dB tested at 18, 23 and 28 GHz guaranteed with measurement accuracy +/-1.5dB for Gain and P1dB, except Gain at 18 GHz with measurement accuracy +/-1.8dB.

Table 1. RF Electrical Characteristics

TA=25°C, Vd=5.0V, Idq=650mA, Vg=-1.1V, Zo=50 Ω

Parameter	18GHz			23GHz			28GHz			Unit	Comment
	Min	Typ	Max	Min	Typ	Max	Min	Typ	Max		
Operational Frequency	18		28	18		28	18		28	GHz	
Small Signal Gain, Gain	21	23		21	23		20	22		dB	
Output Power at 1dB Gain Compression, P1dB	26	28		27	28		27	28		dBm	
Output Third Order Intercept Point, OIP3		35			35			35		dBm	
Reverse Isolation, Isolation		43			43			43		dB	
Input Return Loss, RLin		10			10			10		dB	
Output Return Loss, RLOut		10			10			10		dB	

Table 2. Recommended Operating Range

1. Ambient operational temperature TA = 25°C unless otherwise noted.
2. Channel-to-backside Thermal Resistance (Tchannel (Tch) = 34°C) as measured using infrared microscopy. Thermal Resistance at backside temperature (Tb) = 25°C calculated from measured data.

Description	Min.	Typical	Max.	Unit	Comments
Drain Supply Current, Idq		650		mA	Vd = 5V, Vg set for typical Idq Typical
Gate Supply Voltage, Vg		-1.1		V	Idq = 650mA

Table 3. Thermal Properties

Parameter	Test Conditions	Value
Thermal Resistance (Channel-to-Base Plate), $R_{\theta ch-b}$		$R_{\theta ch-b} = 17.8^{\circ}C/W$
Channel temperature, T_{ch}		$T_{ch} = 142.8^{\circ}C$
Maximum Power Dissipation	$T_{baseplate} = 85^{\circ}C$	
Thermal Resistance (channel to backside), θ_{jc}	$V_d = 5V$ $I_d = 650mA$ $P_D = 3.25W$ $T_{baseplate} = 85^{\circ}C$	$\theta_{jc} = 17.8^{\circ}C/W$ $T_{ch} = 143^{\circ}C$ $P_d = 410$ $T_{ch} = 143^{\circ}C$
Channel Temperature, T_{ch}	$V_d = 5V$ $I_d = 900mA$ $P_{out} = 30dBm$ $P_d = 3.5W$ $T_{baseplate} = 85^{\circ}C$	$\theta_{jc} = 17.8^{\circ}C/W$ $T_{ch} = 147^{\circ}C$

Note:

Assume SnPb soldering to an evaluation RF board at 85°C base plate temperatures. Worst case is at saturated output power when DC power consumption rises to 5.5W with 1.58W RF power delivered to load. Power dissipation is 3.92W and the temperature rise in the channel is 69.8°C. In this condition, the channel temperature reached at the maximum operational channel temperature of 155°C. To maintain the maximum operational temperature below 155°C, the base plate temperature must be maintained below 85°C.

Absolute Minimum and Maximum Ratings

Table 4. Minimum and Maximum Ratings

Description Pin	Min.	Max.	Unit	Comments
Drain to Gate Voltage, V_d-V_g		8	V	
Drain Supply Voltage, V_d		5.5	V	
Gate Supply Voltage, V_g	-2.5	0.5	V	
Power Dissipation, P_d [2,3]		4	W	
RF CW Input Power, P_{in} [3]		20	dBm	CW
Channel Temperature, T_{ch} , max [4]		+150	°C	
Storage Case Temperature, T_{stg}	-65	+155	°C	
Maximum Assembly Temperature, T_{max}		320	°C	30 second maximum

Notes:

1. Operation in excess of any one of these conditions may result in permanent damage to this device.
2. Dissipated power P_D is in any combination of DC voltage, Drain Current, input power and power delivered to the load.
3. When operated at maximum P_D with a base plate temperature of 85 C, the median time to failure (MTTF) is significantly reduced.
4. These ratings apply to each individual FET. The operating channel temperature will directly affect the device MTTF. For maximum life, it is recommended that junction temperatures (T_j) be maintained at the lowest possible levels. See MTTF vs. $T_{channel}$ Temperature Table.

AMMP-6425 Typical Performance

(Data obtained from 2.4-mm connector based test fixture, and this data is including connector loss, and board loss.)
 ($T_A = 25^\circ\text{C}$, $V_d = 5\text{V}$, $I_{dq} = 650\text{mA}$, $V_g = -1.1\text{V}$, $Z_{in} = Z_{out} = 50\Omega$)

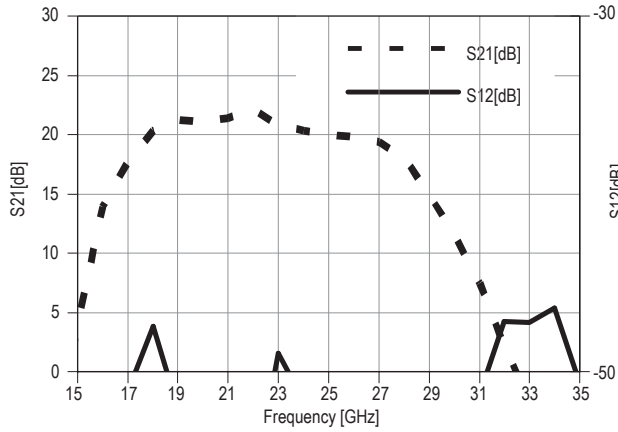

Figure 1. Typical Gain and Reverse Isolation

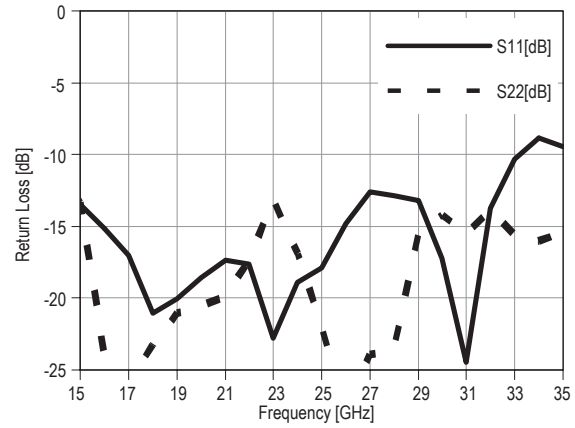

Figure 2. Typical Input & Output Return Loss

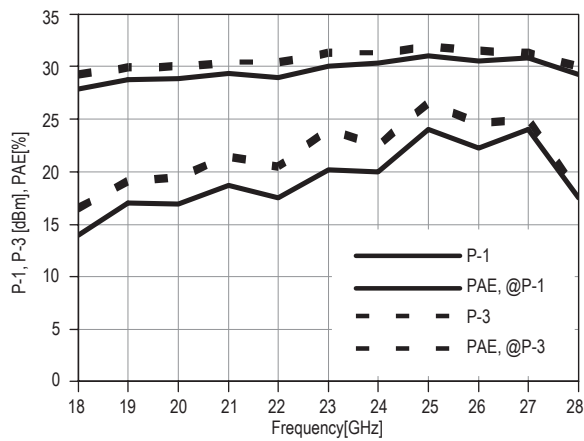

Figure 3. Typical P-1 and PAE

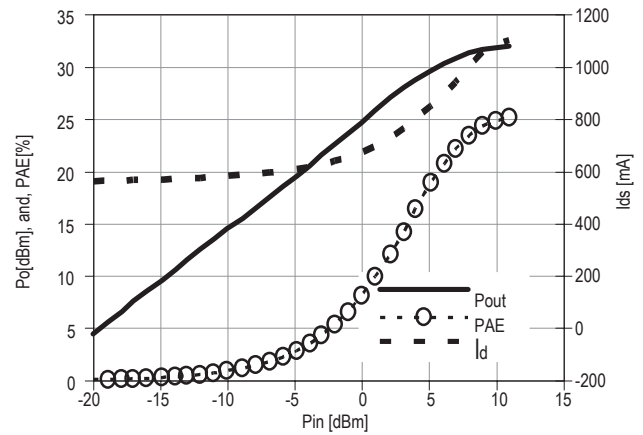

Figure 4. Typical Pout, Ids, and PAE vs. Pin at Freq=25GHz

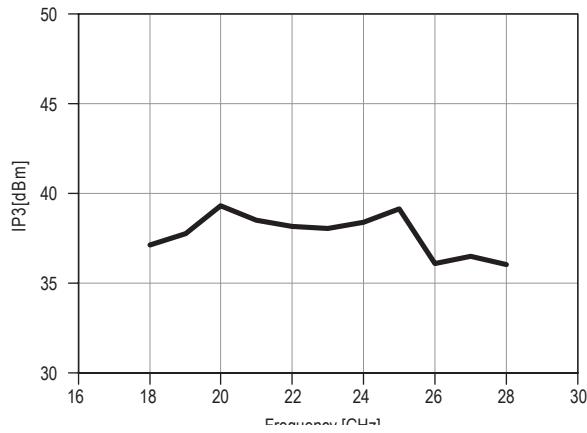

Figure 5. Typical IP3 (Third Order Intercept) @ Pin=-20dBm

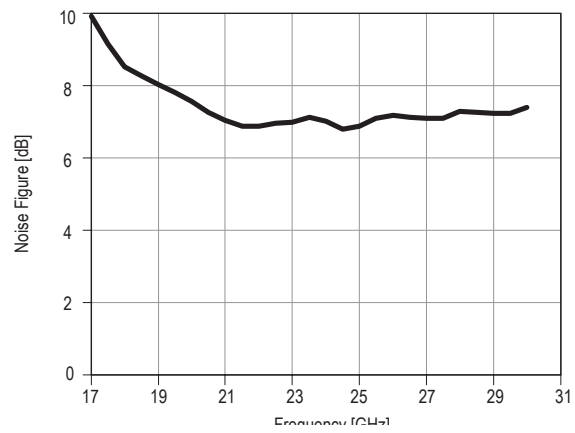

Figure 6. Typical Noise Figure

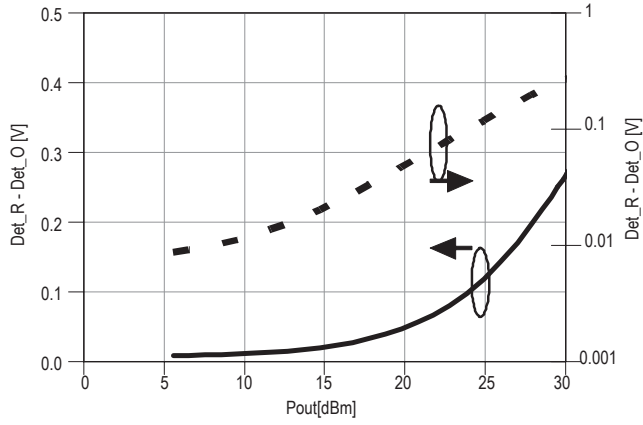

Figure 7. Typical Detector voltage vs. Output Power

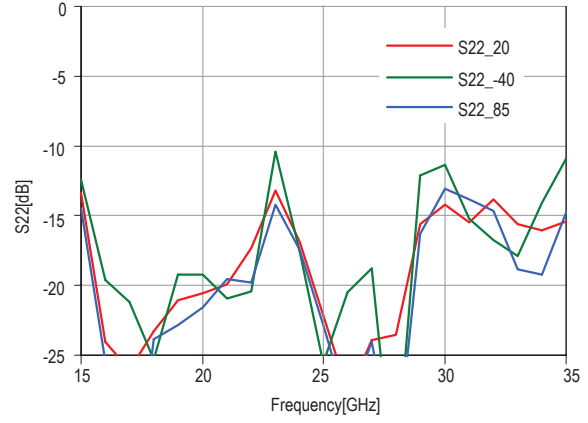

Figure 8. Typical S22 over temperature

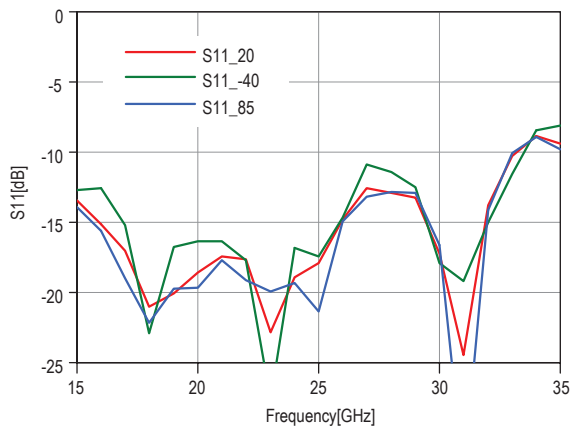

Figure 9. Typical S11 over temperature

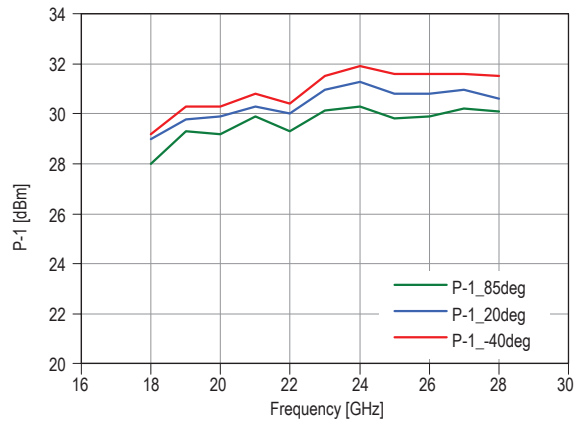

Figure 10. Typical P-1 over temperature

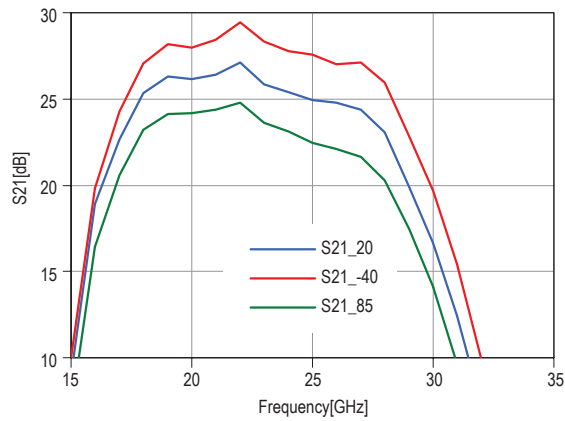

Figure 11. Typical Gain over temperature

Typical Scattering Parameters [1]

($T_A = 25^\circ\text{C}$, $V_d = 5\text{ V}$, $I_{dq} = 650\text{ mA}$, $Z_{in} = Z_{out} = 50\Omega$)

Freq [GHz]	S11			S21			S12			S22		
	dB	Mag	Phase	dB	Mag	Phase	dB	Mag	Phase	dB	Mag	Phase
1	-0.178	0.980	-37.820	-47.292	0.004	-74.488	-80.369	9.58E-05	103.780	-0.085	0.990	-34.276
2	-0.523	0.942	-74.503	-44.008	0.006	149.890	-70.925	2.84E-04	15.146	-0.279	0.968	-68.410
3	-0.978	0.893	-110.430	-46.417	0.005	67.301	-65.116	5.55E-04	-50.709	-0.630	0.930	-102.400
4	-1.451	0.846	-145.650	-46.503	0.005	13.513	-62.769	7.27E-04	-62.503	-1.318	0.859	-134.930
5	-2.031	0.792	178.840	-45.038	0.006	-58.861	-58.964	1.13E-03	-135.670	-1.389	0.852	-167.440
6	-2.704	0.732	143.950	-47.901	0.004	-154.120	-54.809	1.82E-03	178.760	-1.958	0.798	158.670
7	-3.392	0.677	109.310	-49.517	0.003	169.350	-53.665	2.07E-03	141.890	-2.558	0.745	125.480
8	-4.109	0.623	75.156	-50.018	0.003	105.240	-51.070	2.80E-03	104.940	-3.104	0.700	92.207
9	-4.791	0.576	41.436	-53.613	0.002	44.075	-51.693	2.60E-03	53.998	-3.633	0.658	58.406
10	-5.516	0.530	8.579	-56.475	0.002	-12.575	-51.331	2.71E-03	32.567	-4.100	0.624	24.394
11	-6.364	0.481	-23.142	-46.029	0.005	-103.650	-51.167	2.76E-03	11.953	-4.608	0.588	-10.323
12	-7.445	0.424	-52.655	-29.971	0.032	-152.130	-51.615	2.63E-03	3.625	-5.224	0.548	-45.888
13	-8.819	0.362	-78.361	-16.053	0.158	149.700	-50.249	3.07E-03	-15.675	-6.438	0.477	-82.797
14	-10.363	0.303	-98.427	-3.496	0.669	81.099	-50.263	3.07E-03	-28.191	-9.045	0.353	-120.890
15	-11.090	0.279	-112.740	8.685	2.718	-4.135	-46.066	4.97E-03	-65.232	-14.588	0.186	-150.360
16	-12.282	0.243	-131.170	18.694	8.604	-119.950	-46.237	4.88E-03	-110.450	-24.953	0.057	-82.936
17	-12.416	0.239	-151.110	22.143	12.798	128.380	-60.278	9.68E-04	-136.210	-14.586	0.187	-124.060
18	-18.133	0.124	-159.160	25.421	18.666	25.746	-58.209	1.23E-03	-69.871	-17.548	0.133	-113.800
19	-11.405	0.269	-143.530	24.729	17.236	-77.696	-47.566	4.18E-03	-85.440	-9.908	0.320	-139.560
20	-12.614	0.234	172.380	25.037	17.859	-153.820	-45.013	5.61E-03	-114.600	-12.434	0.239	164.360
21	-15.765	0.163	172.820	25.244	18.289	120.010	-46.939	4.50E-03	-153.480	-19.545	0.105	177.540
22	-18.729	0.116	169.430	25.205	18.208	41.393	-46.250	4.87E-03	-155.050	-19.073	0.111	-162.420
23	-19.222	0.109	155.900	24.889	17.557	-34.617	-49.429	3.38E-03	165.260	-19.220	0.109	176.780
24	-16.511	0.149	168.470	23.841	15.562	-111.460	-47.594	4.17E-03	177.280	-17.045	0.141	-178.550
25	-18.712	0.116	146.270	23.888	15.647	-179.450	-46.045	4.99E-03	168.010	-18.114	0.124	171.490
26	-17.947	0.127	175.590	24.682	17.143	103.360	-45.724	5.17E-03	158.550	-16.455	0.150	-178.830
27	-11.711	0.260	168.100	24.823	17.423	13.068	-42.460	7.53E-03	135.940	-11.479	0.267	172.720
28	-10.060	0.314	125.410	22.405	13.191	-74.382	-41.090	8.82E-03	113.320	-11.025	0.281	129.980
29	-13.299	0.216	95.693	19.705	9.666	-157.160	-42.711	7.32E-03	83.227	-15.117	0.175	123.360
30	-17.064	0.140	102.470	16.154	6.422	122.330	-38.921	1.13E-02	55.944	-13.896	0.202	133.650
31	-13.487	0.212	101.410	12.154	4.052	48.186	-44.057	6.27E-03	18.061	-11.050	0.280	111.830
32	-11.785	0.257	84.008	8.383	2.625	-23.332	-46.564	4.70E-03	2.928	-10.645	0.294	91.607
33	-11.532	0.265	62.490	4.076	1.599	-91.933	-53.813	2.04E-03	17.837	-10.575	0.296	76.604
34	-10.906	0.285	45.088	0.130	1.015	-158.780	-55.014	1.78E-03	112.070	-10.010	0.316	61.871
35	-10.536	0.297	23.915	-4.190	0.617	136.430	-48.002	3.98E-03	132.840	-9.589	0.332	45.962
36	-10.699	0.292	-1.693	-8.418	0.379	74.411	-40.193	9.78E-03	80.387	-9.107	0.350	29.444
37	-12.367	0.241	-29.330	-12.489	0.237	15.586	-38.833	1.14E-02	35.254	-8.758	0.365	12.764
38	-17.928	0.127	-55.180	-16.801	0.145	-41.207	-37.437	1.34E-02	6.758	-8.550	0.374	-1.575
39	-23.162	0.069	34.718	-21.962	0.080	-95.210	-34.527	1.88E-02	-16.672	-8.096	0.394	-17.493
40	-11.353	0.271	26.590	-27.653	0.041	-155.570	-36.493	1.50E-02	-57.641	-7.734	0.410	-32.201
41	-7.080	0.443	-9.207	-40.696	0.009	131.530	-36.464	1.50E-02	-63.002	-7.456	0.424	-46.161
42	-5.965	0.503	-39.140	-36.215	0.015	-26.815	-36.100	1.57E-02	-66.924	-6.986	0.447	-60.000
43	-6.061	0.498	-62.125	-33.829	0.020	-89.274	-34.607	1.86E-02	-102.970	-6.790	0.458	-74.546
44	-6.152	0.492	-76.987	-32.808	0.023	-126.740	-33.593	2.09E-02	-126.260	-6.710	0.462	-87.216
45	-5.936	0.505	-89.697	-36.302	0.015	-161.820	-37.542	1.33E-02	-154.850	-6.733	0.461	-98.984

Note:

1. Data obtained from a 2.4-mm connector based module, and this data is including connector loss, and board loss.

AMMP-6425 Biasing and Operation

Recommended quiescent DC bias condition for optimum power and linearity performances is $V_d=5$ volts with V_g (-1.1V) set for $I_{dq}=650$ mA. Minor improvements in performance are possible depending on the application. The drain bias voltage range is 3 to 5V. A single DC gate supply connected to V_g will bias all gain stages. Muting can be accomplished by setting V_{gg} to the pinch-off voltage V_p .

A simplified schematic for the AMMP6425 MMIC die is shown in Figure 12. The MMIC die contains ESD and over voltage protection diodes for V_g , and V_{dd} terminals. The package diagram for the recommended assembly is shown in Figure 13. In finalized package form, ESD diodes protect all possible ESD or over voltage damages between V_g and ground, V_g and V_d , V_d and ground. Typical ESD diode current versus diode voltage for 11-connected diodes in series is shown in Figure 14. Under the recommended DC quiescent biasing condition at $V_{ds}=5V$, $I_{ds}=650mA$, $V_g=-1V$, typical gate terminal current is approximately 0.3mA. If an active biasing technique is selected for the AMMP6425 MMIC PA DC biasing, the active biasing circuit must have more than 10-times higher internal current that the gate terminal current.

An optional output power detector network is also provided. The differential voltage between the Det-Ref and Det-Out pads can be correlated with the RF power

emerging from the RF output port. The detected voltage is given by :

$$V = (V_{ref} - V_{det}) - V_{ofs}$$

where V_{ref} is the voltage at the DET_R port, V_{det} is a voltage at the DET_0 port, V_{ofs} and is the zero-input-power offset voltage.

There are three methods to calculate V_{ofs} :

1. V_{ofs} can be measured before each detector measurement (by removing or switching off the power source and measuring $V_{ref} - V_{det}$). This method gives an error due to temperature drift of less than 0.01dB/50°C.
2. V_{ofs} can be measured at a single reference temperature. The drift error will be less than 0.25dB.
3. V_{ofs} can either be characterized over temperature and stored in a lookup table, or it can be measured at two temperatures and a linear fit used to calculate V_{ofs} at any temperature. This method gives an error close to the method #1.

The RF ports are AC coupled at the RF input to the first stage and the RF output of the final stage. No ground wires are needed since ground connections are made with plated through-holes to the backside of the device.

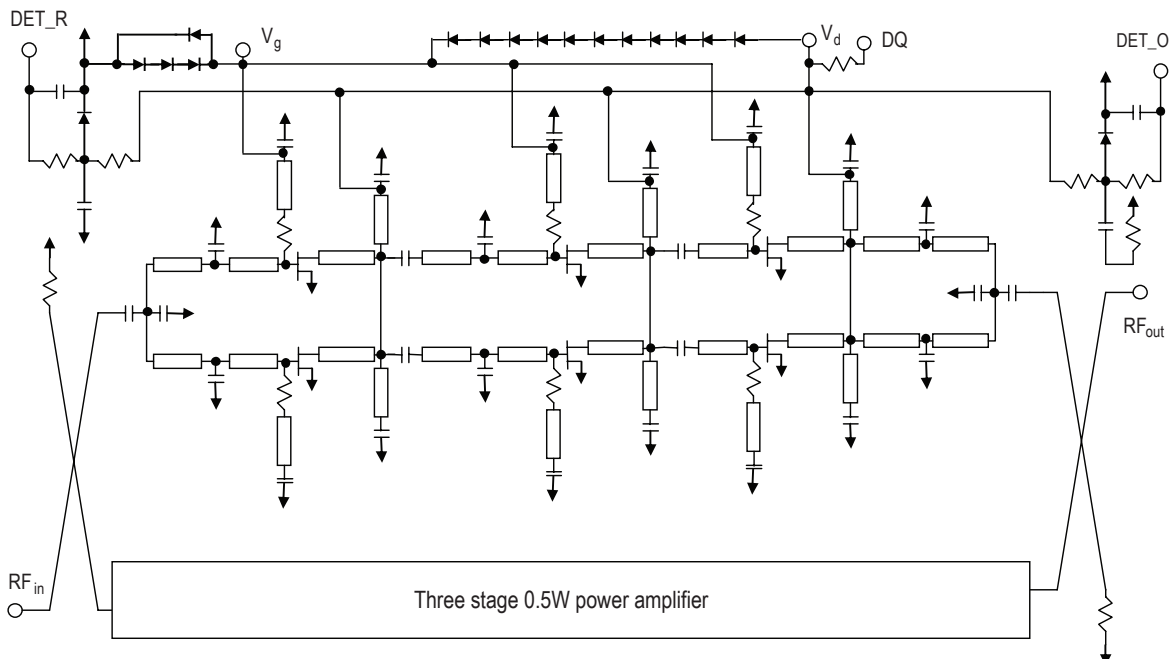
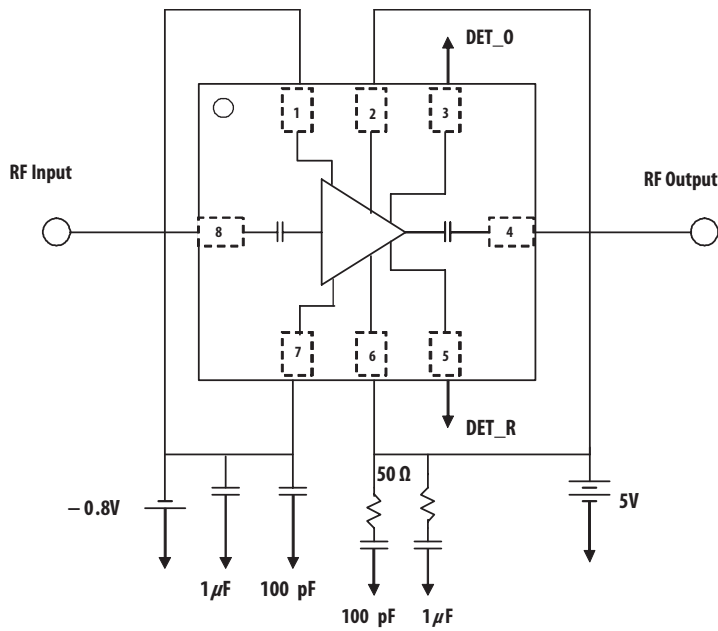

Figure 12. Simplified schematic for the MMIC die



Pin	Function
1	Vg
2	Vd
3	DET_0
4	RF_out
5	DET_R
6	Vd
7	Vg
8	RF_in

Figure 13. Typical DC connection

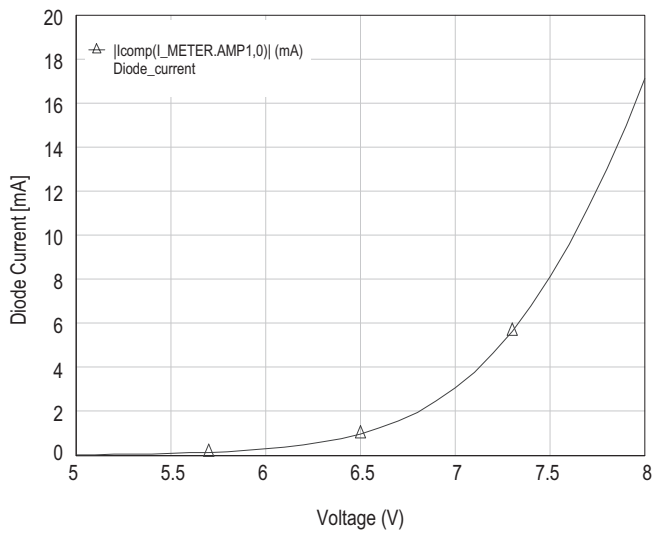

Figure 14. Typical ESD diode current versus diode voltage for 11-connected diodes in series

Note:

No RF performance degradation is seen due to ESD up to 200V HBM and 60V MM. The DC characteristics in general show increased leakage at lower ESD discharge voltages. The user is reminded that this device is ESD sensitive and needs to be handled with all necessary ESD protocols.

Package Dimension, PCB Layout and Tape and Reel information

Please refer to Avago Technologies Application Note 5520, AMxP-xxxx production Assembly Process (Land Pattern A).

AMMP-6425 Part Number Ordering Information

Part Number	Devices Per Container	Container
AMMP-6425-BLKG	10	Antistatic bag
AMMP-6425-TR1G	100	7" Reel
AMMP-6425-TR2G	500	7" Reel

For product information and a complete list of distributors, please go to our web site: www.avagotech.com

Avago, Avago Technologies, and the A logo are trademarks of Avago Technologies in the United States and other countries.
Data subject to change. Copyright © 2005-2013 Avago Technologies. All rights reserved.
AV02-0034EN - July 8, 2013



X-ON Electronics

Largest Supplier of Electrical and Electronic Components

Click to view similar products for [RF Amplifier](#) category:

Click to view products by [Broadcom](#) manufacturer:

Other Similar products are found below :

[A82-1](#) [BGA622H6820XTSA1](#) [BGA 728L7 E6327](#) [BGB719N7ESDE6327XTMA1](#) [HMC397-SX](#) [HMC405](#) [HMC561-SX](#) [HMC8120-SX](#)
[HMC8121-SX](#) [HMC-ALH382-SX](#) [HMC-ALH476-SX](#) [SE2433T-R](#) [SMA3101-TL-E](#) [SMA39](#) [A66-1](#) [A66-3](#) [A67-1](#) [A81-2](#) [LX5535LQ](#)
[LX5540LL](#) [MAAM02350](#) [HMC3653LP3BETR](#) [HMC549MS8GETR](#) [HMC-ALH435-SX](#) [SMA101](#) [SMA32](#) [SMA411](#) [SMA531](#)
[SST12LP19E-QX6E](#) [WPM0510A](#) [HMC5929LS6TR](#) [HMC5879LS7TR](#) [HMC1087F10](#) [HMC1086](#) [HMC1016](#) [SMA1212](#) [MAX2689EWS+T](#)
[MAAMSS0041TR](#) [MAAM37000-A1G](#) [LTC6430AIUF-15#PBF](#) [SMA70-2](#) [SMA4011](#) [A231](#) [HMC-AUH232](#) [LX5511LQ](#) [LX5511LQ-TR](#)
[HMC7441-SX](#) [HMC-ALH310](#) [XD1001-BD-000V](#) [A4011](#)