

High Brightness Tall Black Surface PLCC6 Tricolor LED

Data Sheet

Description

This family of SMT LEDs is packaged in the form of PLCC-6 with a separate heat path for each LED die, enabling it to be driven at higher current.

Individually addressable pin-outs give higher flexibility in circuitry design. With closely matched radiation pattern along the package's X-axis, these LEDs are suitable for full color display application. The black top surface of the LED provides better contrast enhancement.

For easy pick and place, the LEDs are shipped in tape and reel. Every reel is shipped from a single intensity and color bin for better uniformity.

These LEDs are compatible with reflow soldering process.

CAUTION These LEDs are ESD-sensitive. Please observe appropriate precautions during handling and processing. Please refer to Avago Application Note AN-1142 for additional details.

CAUTION Customer is advised to keep the LED in the MBB when not in use, as prolonged exposure to environment might cause the silver-plated leads to tarnish, which might cause difficulties in soldering.

Features

- Standard PLCC-6 package (Plastic Leaded Chip Carrier)
 - LED package with diffused encapsulation
 - Tall package enable potting on LED's lead.
 - High brightness using AlInGaP and InGaN dice technologies
 - Typical viewing angle at 115°
 - Compatible with reflow soldering process
 - JEDEC MSL 4
 - Enhanced corrosion resistance.
 - Water resistance (IPx6* and IPx8) per IEC 60529:2001
- * The test is conducted on component level by mounting the components on PCB with potting to protect the leads. It is strongly recommended that customers perform necessary tests on the components for their final application.

Applications

- Full color display

Package Dimensions

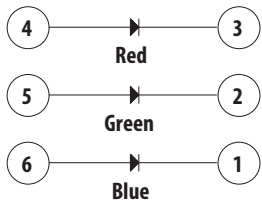
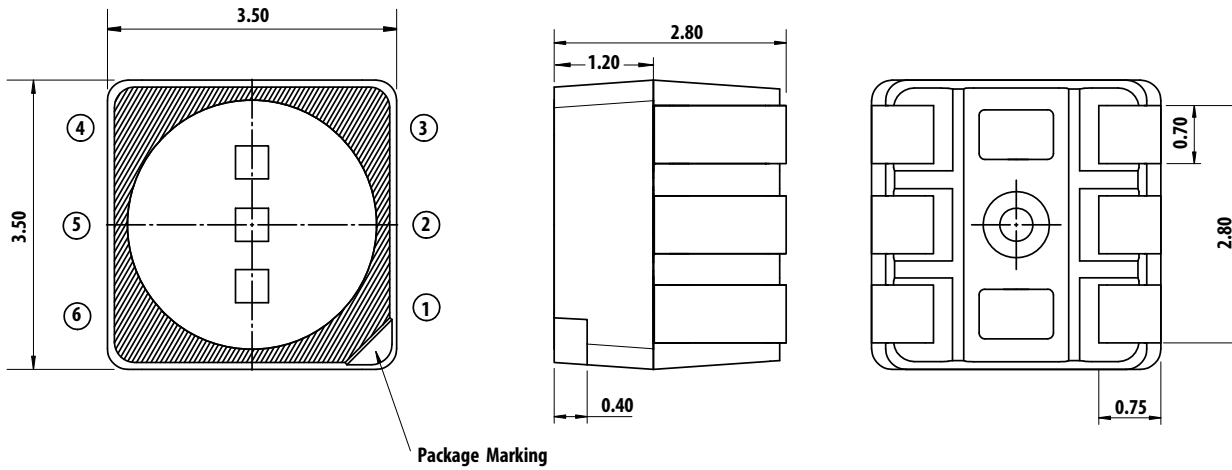

Lead Configuration

1	Cathode (Blue)
2	Cathode (Green)
3	Cathode (Red)
4	Anode (Red)
5	Anode (Green)
6	Anode (Blue)

NOTE

1. All dimensions are in millimeters (mm).
2. Unless otherwise specified, tolerance is ± 0.20 mm.
3. Terminal finish = silver plating.

Absolute Maximum Ratings (T_J = 25 °C)

Parameter	Red	Green & Blue	Unit
DC forward current ^a	50	35	mA
Peak forward current ^b	100	100	mA
Power dissipation	130	126	mW
Maximum junction temperature T _J max	110		°C
Operating temperature range	-40 to +100		°C
Storage temperature range	-40 to +100		°C

- a. Derate linearly as shown in [Figure 7](#) to [Figure 10](#).
b. Duty Factor = 10% Frequency = 1 kHz

Optical Characteristics (T_J = 25 °C)

Color	Luminous Intensity, I _V (mcd) @ I _F = 20mA ^a			Dominant Wavelength, λ _d (nm) @ I _F = 20mA ^b			Peak Wavelength, λ _p (nm) @ I _F = 20m	Viewing Angle, 2θ _{1/2} (°) ^c
	Min.	Typ.	Max.	Min.	Typ.	Max.	Typ.	Typ.
Red	560	790	1125	618	621	628	635	115
Green	1800	2400	3550	523	530	535	521	115
Blue	355	500	715	465	470	473	464	115

- a. The luminous intensity I_V is measured at the mechanical axis of LED package and it is tested in pulsing condition. The actual peak of the spatial radiation pattern may not be aligned with the axis.
b. The dominant wavelength is derived from the CIE Chromaticity Diagram and represents the perceived color of the device.
c. θ_{1/2} is the off axis angle where the luminous intensity is 1/2 the peak intensity

Electrical Characteristics (T_J = 25 °C)

Color	Forward Voltage, V _F (V) @ I _F = 20mA ^a			Reverse Voltage, V _R (V) @ I _R = 100μA ^b	Reverse Voltage, V _R (V) @ I _R = 10μA ^b	Thermal Resistance, R _{θJ-S} (°C/W)	
	Min.	Typ.	Max.	Min.	Min.	1 chip on	3 chips on
Red	1.8	2.1	2.5	4	—	320	320
Green	2.8	3.1	3.6	—	4	320	320
Blue	2.8	3.1	3.6	—	4	320	320

- a. Tolerance = ±0.1V.
b. Indicates product final testing condition. Long term reverse bias is not recommended.

Part Numbering System

A S M B - T T B 0 - 0 A 3 A 2

x1

x2 x3 x4 x5

Code	Description	Option		
x1	Package type	B	Black surface	
x2	Minimum intensity bin	A	Red: bin U2	Red: bin U2, V1, V2
			Green: bin X1	Green: bin X1, X2, Y1
			Blue: bin T2	Blue: bin T2, U1, U2
x3	Number of intensity bins	3	3 intensity bins from minimum	
x4	Color bin combination	A	Red: full distribution	
			Green: bin E, A, B	
			Blue: bin A, B, C	
x5	Test option	2	Test current = 20 mA	

Bin Information

Intensity Bins (CAT)

Bin ID	Luminous intensity (mcd)	
	Min	Max
T2	355	450
U1	450	560
U2	560	715
V1	715	900
V2	900	1125
W1	1125	1400
W2	1400	1800
X1	1800	2240
X2	2240	2850
Y1	2850	3550

Tolerance: $\pm 12\%$

Color Bins (BIN) – Blue

Bin ID	Dominant Wavelength (nm)		Chromaticity Coordinate (for Reference)	
	Min.	Max.	Cx	Cy
A	465.0	469.0	0.1355	0.0399
			0.1553	0.0692
			0.1473	0.0814
			0.1267	0.0534
B	467.0	471.0	0.1314	0.0459
			0.1516	0.0746
			0.1427	0.0897
			0.1215	0.0626
C	469.0	473.0	0.1267	0.0534
			0.1473	0.0814
			0.1376	0.0996
			0.1158	0.0736

Tolerance: ± 1 nm.

Color Bins (BIN) – Red

Bin ID	Dominant Wavelength (nm)		Chromaticity Coordinate (for Reference)	
	Min.	Max.	Cx	Cy
—	618.0	628.0	0.6873	0.3126
			0.6696	0.3136
			0.6866	0.2967
			0.7052	0.2948

Tolerance: ± 1 nm.

Color Bins (BIN) – Green

Bin ID	Dominant Wavelength (nm)		Chromaticity Coordinate (for Reference)	
	Min.	Max.	Cx	Cy
E	523.0	529.0	0.0979	0.8316
			0.1685	0.6821
			0.2027	0.6673
			0.1468	0.8104
A	526.0	532.0	0.1223	0.8228
			0.1856	0.6759
			0.2192	0.6576
			0.1702	0.7965
B	529.0	535.0	0.1468	0.8104
			0.2027	0.6673
			0.2350	0.6471
			0.1929	0.7816

Tolerance: ± 1 nm.

Figure 1 Relative Intensity vs. Wavelength

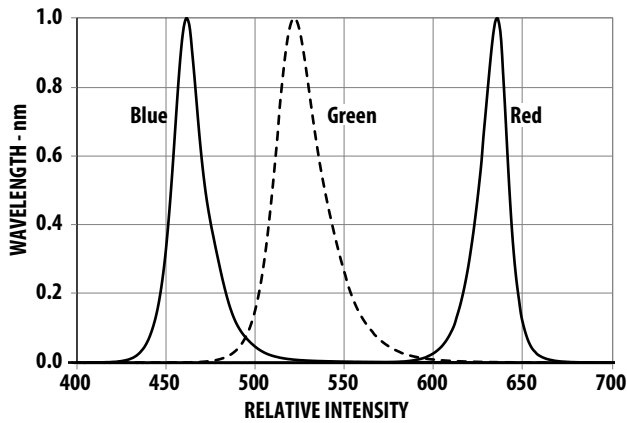

Figure 2 Forward Current vs. Forward Voltage

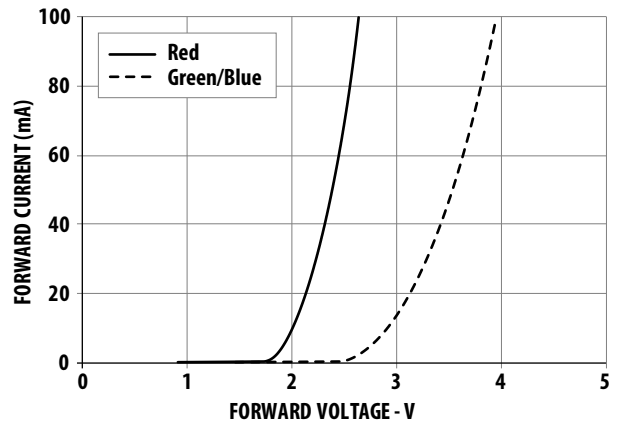

Figure 3 Relative Intensity vs. Forward Current

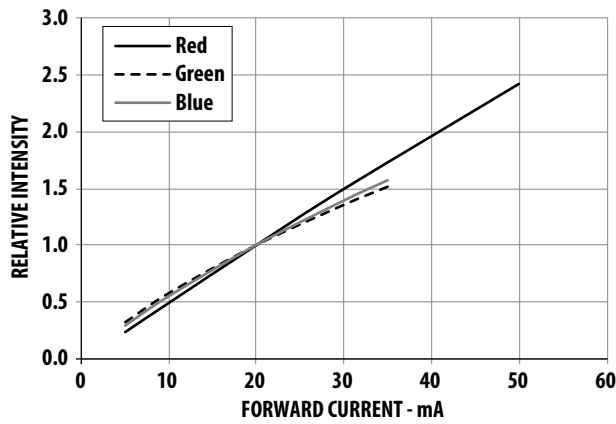

Figure 4 Dominant Wavelength Shift vs. Forward Current

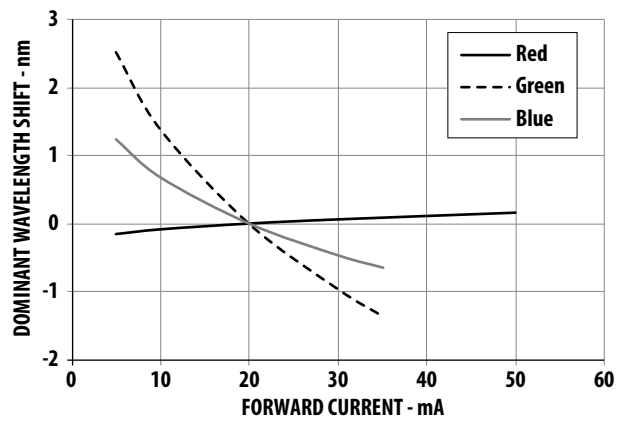

Figure 5 Relative Intensity vs. Junction Temperature

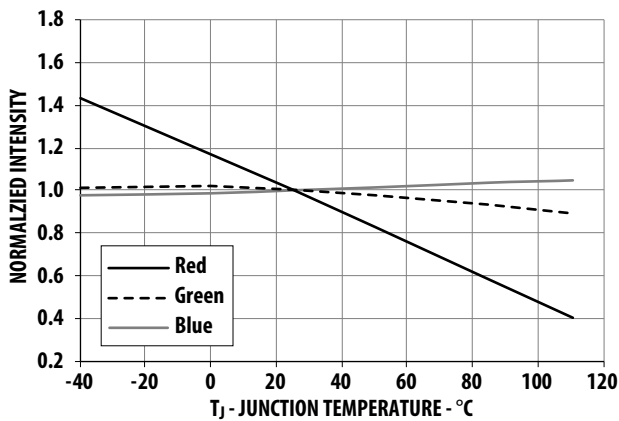

Figure 6 Forward Voltage vs. Junction Temperature

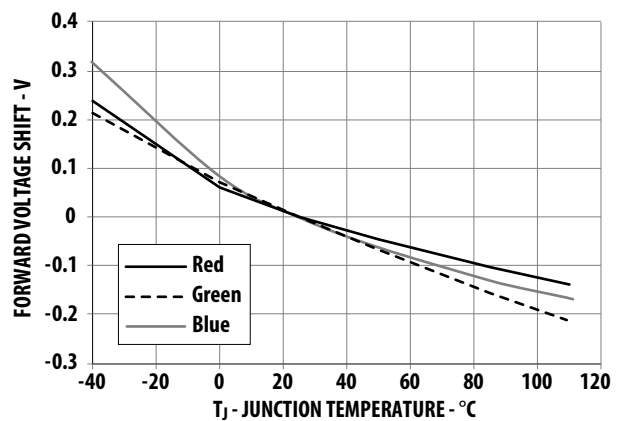

Figure 7 Maximum Forward Current vs. Temperature for Red (1 Chip On)

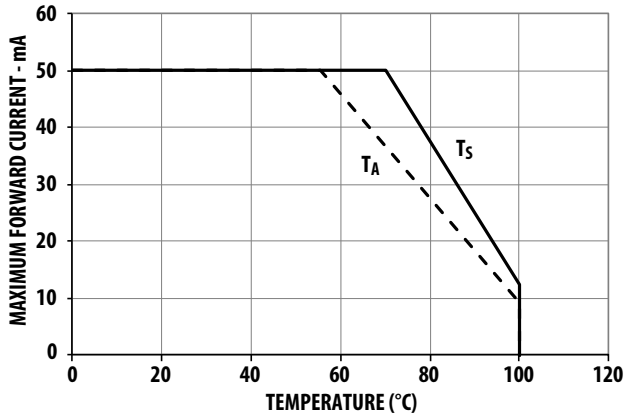

Figure 8 Maximum Forward Current vs. Temperature for Red (3 Chips On)

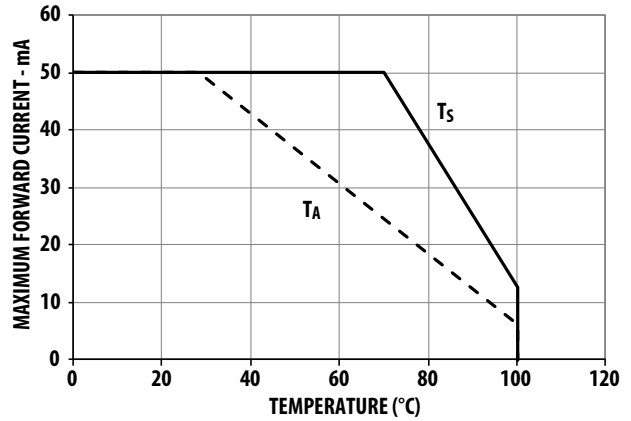

Figure 9 Maximum Forward Current vs. Temperature for Green and Blue (1 Chip On)

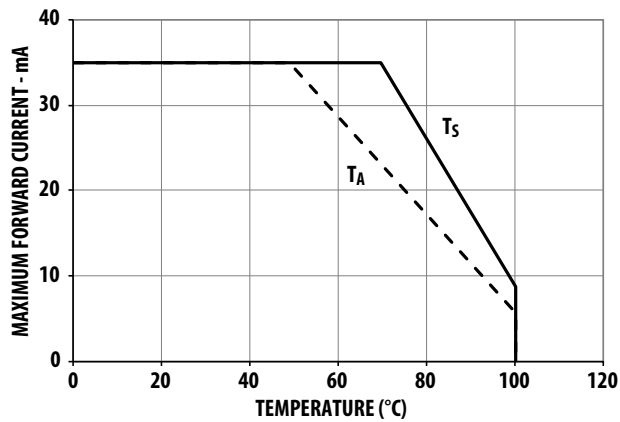
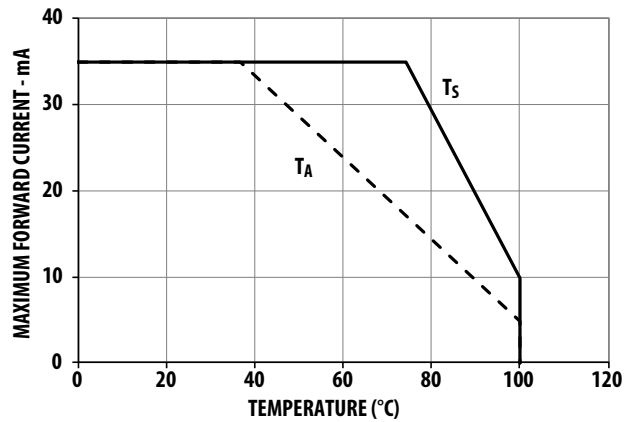

Figure 10 Maximum Forward Current vs. Temperature for Green and Blue (3 Chips On)



NOTE Maximum forward current graphs based on ambient temperature, T_A are with reference to thermal resistance $R_{\theta J-A}$ as follows. For more details, see Precautionary Notes (4).

Condition	Thermal Resistance from LED Junction to Ambient, $R_{\theta J-A}$ ($^{\circ}\text{C}/\text{W}$)	
	Red	Green and Blue
1 chip on	437	485
3 chips on	654	654

Figure 11 Radiation Pattern Along X-Axis of the Package

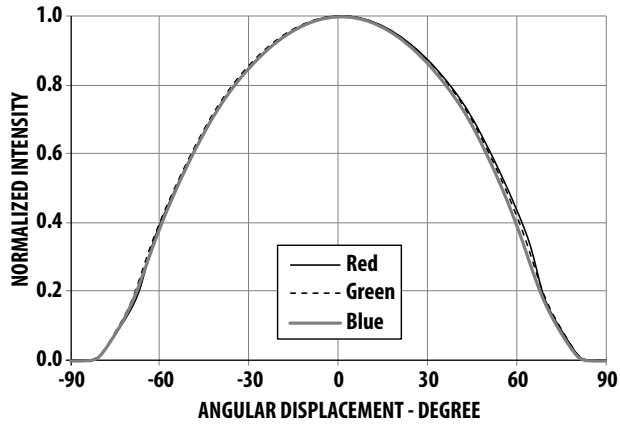

Figure 12 Radiation Pattern Along Y-Axis of the Package

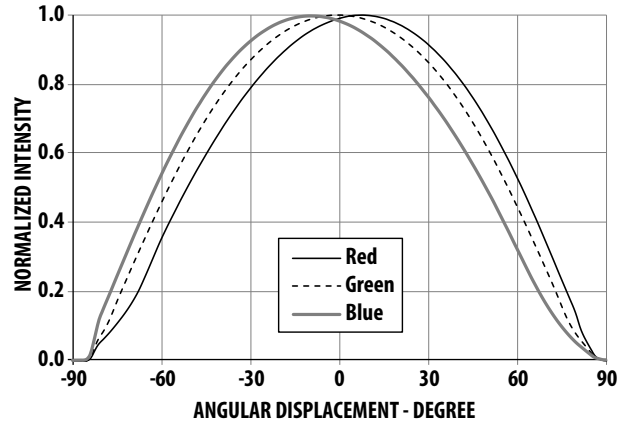

Figure 13 Illustration of Package Axis for Radiation Pattern

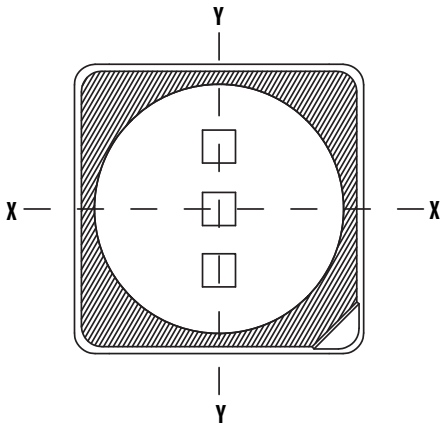

Figure 14 Recommended Soldering Land Pattern

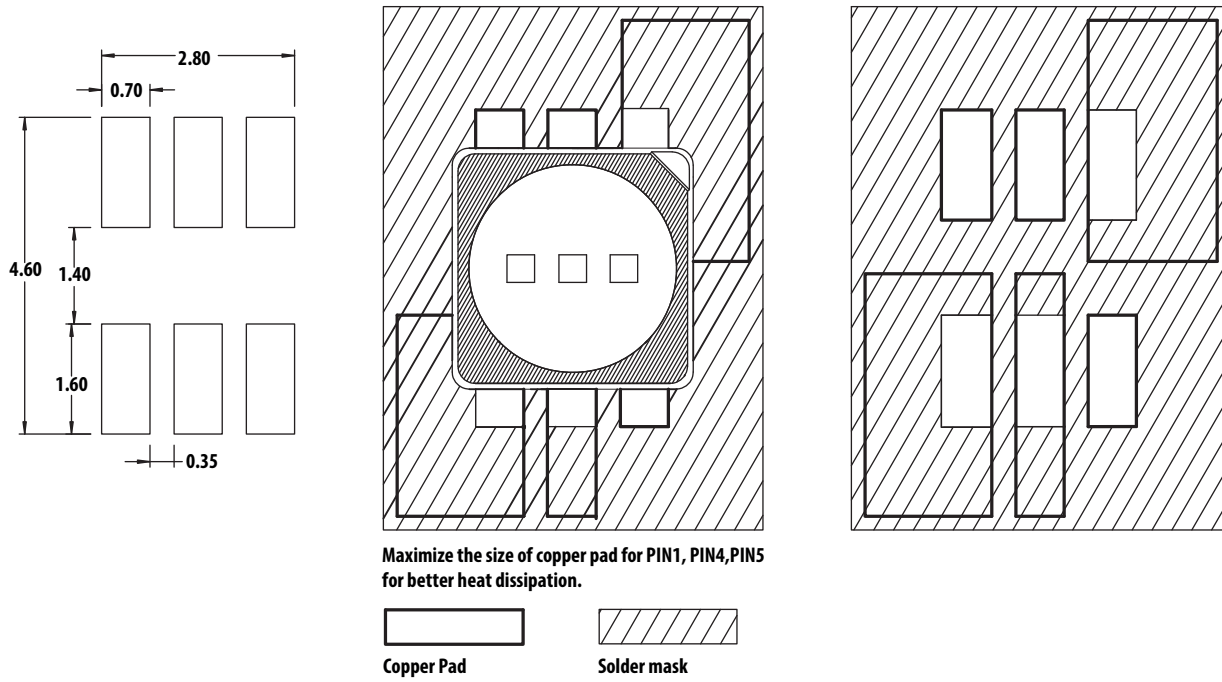

Figure 15 Carrier Tape Dimensions

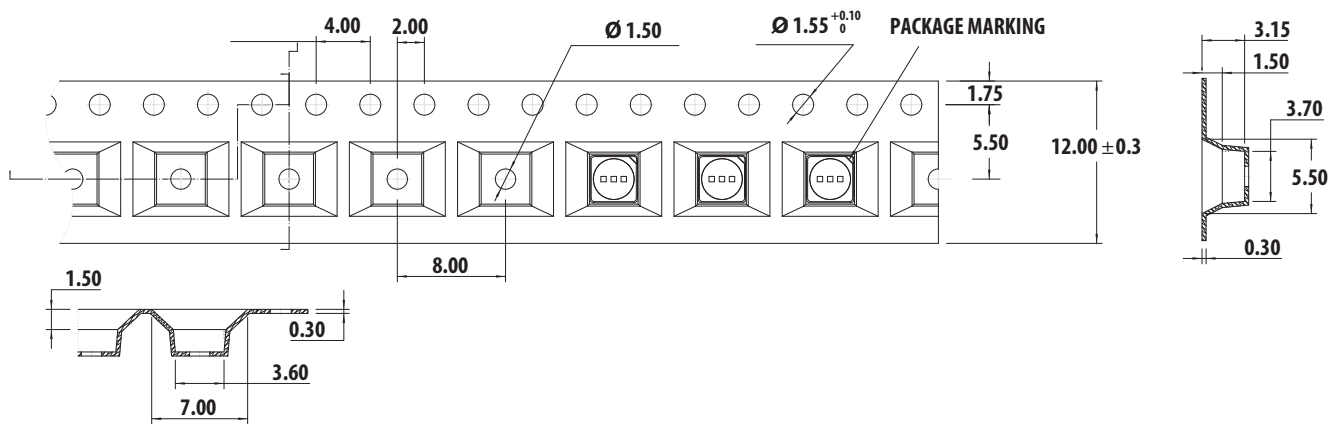

Figure 16 Reel Orientation

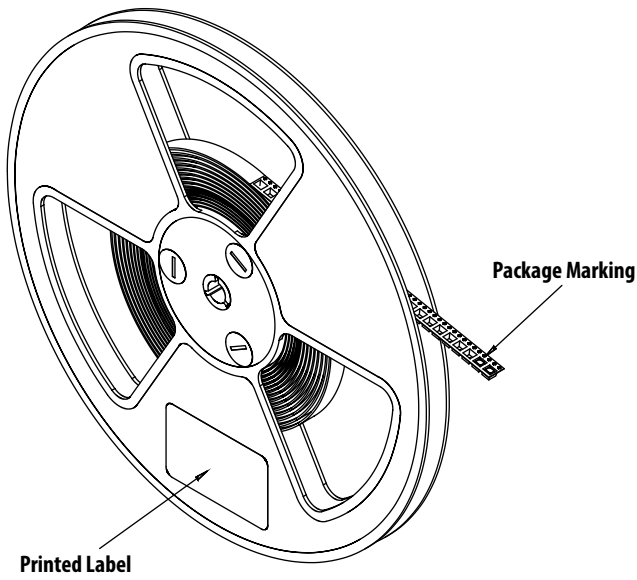
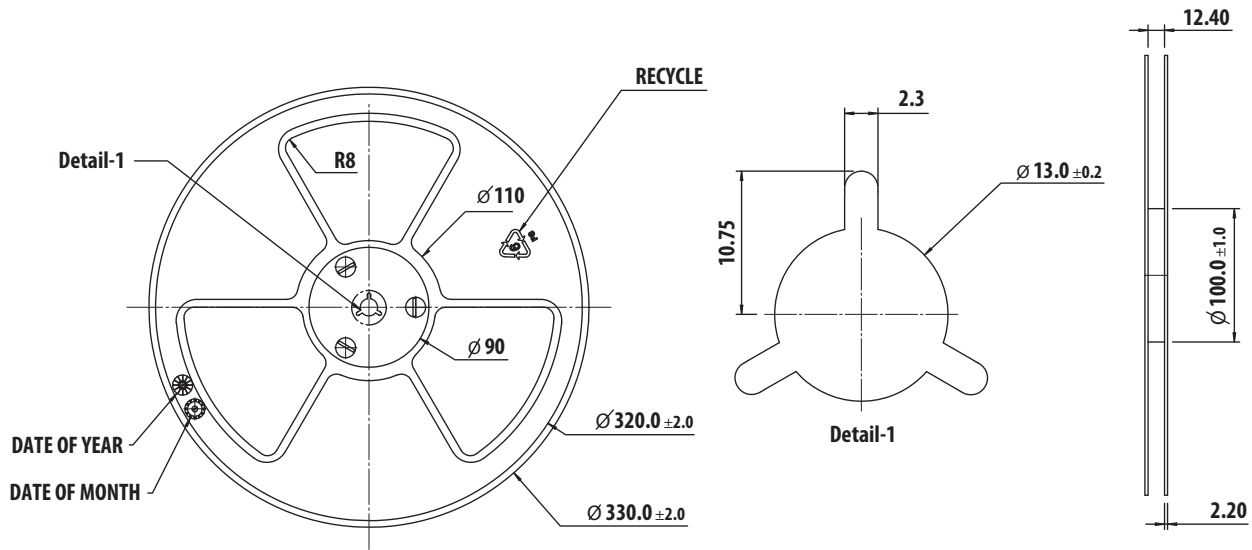

Figure 17 Reel Dimensions



Packing Label

(i) Standard Label (Attached on Moisture Barrier Bag)

<p>AvAGO TECHNOLOGIES STANDARD LABEL LS0002 RoHS Compliant Halogen Free e4 Max Temp 260C MSL4</p>	
(1P) Item: Part Number 	(Q) QTY: Quantity
(1T) Lot: Lot Number 	CAT: Intensity Bin
LPN: 	BIN: Color Bin
(9D) MFG Date: Manufacturing Date 	
(P) Customer Item: 	
(V) Vendor ID: 	(9D) Date Code: Date Code
DeptID: 	Made In: Country of Origin

(ii) Baby Label (Attached on Plastic Reel)

<p>AvAGO TECHNOLOGIES BABY LABEL COSB 001B V0.0</p>	
(1P) PART #: Part Number 	QUANTITY: Packing Quantity
(1T) LOT #: Lot Number 	(9D): DATE CODE:
(9D)MFG DATE: Manufacturing Date 	
C/O: Country of Origin 	
(1T) TAPE DATE: 	D/C: Date Code VF: CAT: INTENSITY BIN BIN: COLOR BIN

Example of Luminous Intensity (Iv) Bin Information on Label

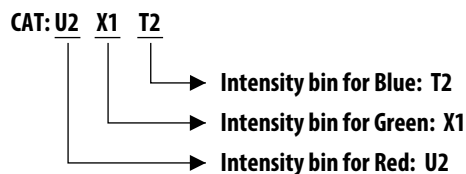

Example of Color Bin Information on Label

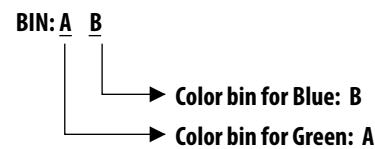

NOTE There is no color bin ID for Red color as there is only one range as stated in Table 4.

Soldering

Recommended reflow soldering condition

(i) Leaded Reflow Soldering

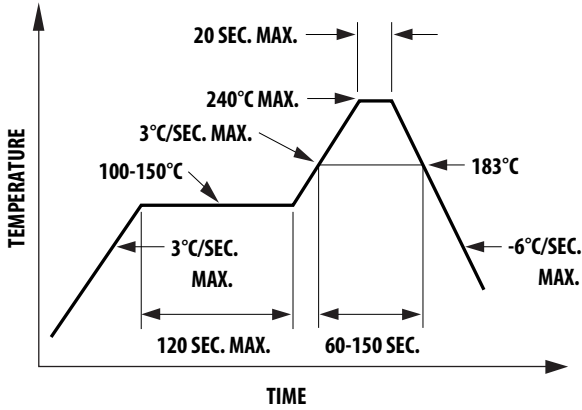

1. Reflow soldering must not be done more than 2 times. Do observe necessary precautions of handling moisture sensitive device as stated in the following section.
2. Recommended board reflow direction:

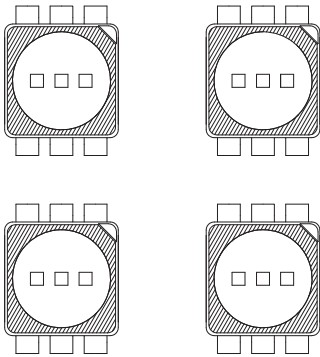

(ii) Lead-Free Reflow Soldering

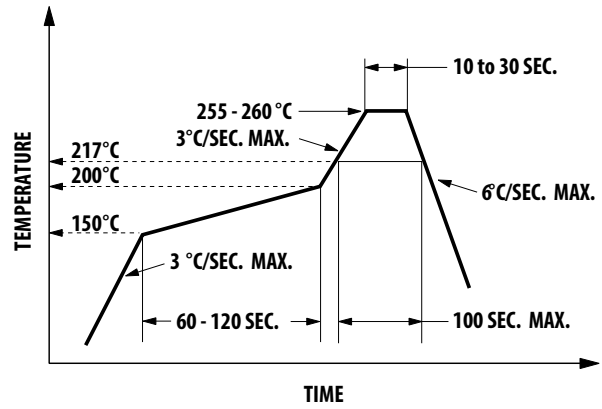

3. Do not apply any pressure or force on the LED during reflow and after reflow when the LED is still hot.
4. It is preferred to use reflow soldering to solder the LED. Hand soldering shall only be used for rework if unavoidable but must be strictly controlled to the following conditions:
 - Soldering iron tip temperature = 320 °C max
 - Soldering duration = 3 sec max
 - Number of cycles = 1 only
 - Power of soldering iron = 50W max
5. Do not touch the LED body with hot soldering iron except the soldering terminals as it may cause damage to the LED.
6. For de-soldering, it is recommended to use double flat tip.
7. The user is advised to confirm beforehand whether the functionality and performance of the LED is affected by hand soldering.

Precautionary Notes

1. Handling precautions

- a. Do not poke sharp objects into the encapsulant. Sharp object like tweezers or syringes might apply excessive force or even pierce through the encapsulant and induce failures to the LED die or wire bond.
- b. Do not touch the encapsulant. Uncontrolled force acting on the encapsulant might result in excessive stress on the wire bond. The LED should only be held by the body.
- c. Do not stack assembled PCBs together. Use an appropriate rack to hold the PCBs.
- d. To remove foreign particles on the surface of the encapsulant, a cotton bud can be used with isopropyl alcohol (IPA). During cleaning, rub the surface gently without applying too much pressure. Ultrasonic cleaning is not recommended.
- e. For automated pick and place, Avago has tested the following nozzle size to be working fine with this LED. However, due to the possibility of variations in other parameters such as pick and place machine maker/model and other settings of the machine, customer is recommended to verify the nozzle selected will not cause damage to the LED.

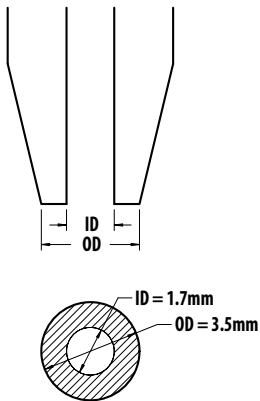

2. Handling of moisture sensitive device

This product has a Moisture Sensitive Level 4 rating per JEDEC J-STD-020. Refer to Avago Application Note AN5305, *Handling of Moisture Sensitive Surface Mount Devices*, for additional details and a review of proper handling procedures.

- a. Before use
 - An unopened moisture barrier bag (MBB) can be stored at $< 40\text{ }^{\circ}\text{C} / 90\%\text{RH}$ for 12 months. If the actual shelf life has exceeded 12 months and the humidity indicator card (HIC) indicates that baking is not required, then it is safe to reflow the LEDs per the original MSL rating.

- It is recommended that the MBB not be opened prior to assembly (e.g., for IQC).
- b. Control after opening the MBB
 - The humidity indicator card (HIC) shall be read immediately upon opening of MBB.
 - The LEDs must be kept at $< 30\text{ }^{\circ}\text{C} / 60\%\text{RH}$ at all times and all high temperature related processes including soldering, curing or rework need to be completed within 72 hours.
- c. Control for unfinished reel
 - Unused LEDs must be stored in a sealed MBB with desiccant or desiccator at $< 5\%\text{RH}$.
- d. Control of assembled boards
 - If the PCB soldered with the LEDs is to be subjected to other high temperature processes, the PCB must be stored in a sealed MBB with desiccant or desiccator at $< 5\%\text{RH}$ to ensure that all LEDs have not exceeded their floor life of 72 hours.
- e. Baking is required if:
 - The HIC indicator is not BROWN at 10% and is AZURE at 5%.
 - The LEDs are exposed to condition of $> 30\text{ }^{\circ}\text{C} / 60\%\text{RH}$ at any time.
 - The LED floor life exceeded 72 hrs.

The recommended baking condition is: $60\pm 5\text{ }^{\circ}\text{C}$ for 24 hrs.

Baking should only be done once.
- f. Storage
 - The soldering terminals of these Avago LEDs are silver plated. If the LEDs are exposed too long in an ambient environment, the silver plating might be oxidized and thus affect its solderability performance. As such, unused LEDs must be kept in a sealed MBB with desiccant or in a desiccator at $< 5\%\text{RH}$.

3. Application precautions

- a. The drive current of the LED must not exceed the maximum allowable limit across temperature as stated in the data sheet. Constant current driving is recommended to ensure consistent performance.
- b. LEDs do exhibit slightly different characteristics at different drive currents that might result in larger performance variations (i.e., intensity, wavelength, and forward voltage). The user is recommended to set the application current as close as possible to the test current to minimize these variations.

- c. The LED is not intended for reverse bias. Use other appropriate components for such purposes. When driving the LED in matrix form, it is crucial to ensure that the reverse bias voltage does not exceed the allowable limit of the LED.
- d. This LED is designed to have enhanced gas corrosion resistance. Its performance has been tested according to the following specific conditions:
 - IEC 60068-2-43: 25 °C / 75%RH, H₂S 15 ppm, 21 days
 - IEC 60068-2-42: 25 °C / 75%RH, SO₂ 25 ppm, 21 days
 - IEC 60068-2-60: 25 °C / 75%RH, SO₂ 200 ppb, NO₂ 200 ppb, Cl₂ 10 ppb, 21 days

As actual application conditions might not be exactly similar to the test conditions, the user is advised to verify that the LED will not be damaged by prolonged exposure in the intended environment.

- e. Avoid rapid change in ambient temperature especially in high humidity environment because this will cause condensation on the LED.
- f. Although the LED is rated as IPx6 and IPx8 according to IEC60529: Degree of protection provided by enclosure, the test condition may not represent actual exposure during the application. If the LED is intended to be used in an outdoor or a harsh environment, the LED must be protected against damages caused by rain water, water, dust, oil, corrosive gases, external mechanical stress, etc.

4. Thermal management

Optical, electrical, and reliability characteristics of the LED are affected by temperature. The junction temperature (T_J) of the LED must be kept below the allowable limit at all times. T_J can be calculated as below:

$$T_J = T_A + R_{\theta J-A} \times I_F \times V_{Fmax}$$

where;

T_A = ambient temperature (°C)

$R_{\theta J-A}$ = thermal resistance from LED junction to ambient (°C/W)

I_F = forward current (A)

V_{Fmax} = maximum forward voltage (V)

The complication of using this formula lies in T_A and $R_{\theta J-A}$. Actual T_A is sometimes subjective and hard to determine. $R_{\theta J-A}$ varies from system to system depending on design and is usually not known.

Another way of calculating T_J is by using solder point temperature T_S as shown below:

$$T_J = T_S + R_{\theta J-S} \times I_F \times V_{Fmax}$$

where;

T_S = LED solder point temperature as shown in the following illustration (°C)

$R_{\theta J-S}$ = thermal resistance from junction to solder point (°C/W)

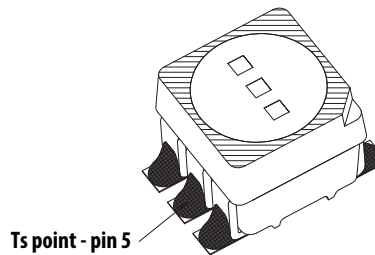

T_S can be measured easily by mounting a thermocouple on the soldering joint as shown in the preceding illustration, while $R_{\theta J-S}$ is provided in the data sheet. The user is advised to verify the T_S of the LED in the final product to ensure that the LEDs are operated within all maximum ratings stated in the data sheet.

5. Eye safety precautions

LEDs may pose optical hazards when in operation. It is not advisable to view directly at operating LEDs as it may be harmful to the eyes. For safety reasons, use appropriate shielding or personal protective equipments.

For product information and a complete list of distributors, please go to our web site:

www.avagotech.com

Avago Technologies and the A logo are trademarks of Avago Technologies in the United States and other countries. All other brand and product names may be trademarks of their respective companies.

This data sheet (including, without limitation, the Avago component [s] identified herein) is not designed, intended, or certified for use in any military, nuclear, medical, mass transportation, aviation, navigations, pollution control, hazardous substances management, or other high-risk application. Avago provides this data sheet "as-is," without warranty of any kind. Avago disclaims all warranties, expressed and implied, including, without limitation, the implied warranties of merchantability, fitness for a particular purpose, and noninfringement.

Data subject to change. Copyright © 2014–2016 Avago Technologies. All Rights Reserved.

AV02-4415EN – April 18, 2016

Avago
TECHNOLOGIES



Lead (Pb) Free
RoHS 6 fully
compliant

X-ON Electronics

Largest Supplier of Electrical and Electronic Components

Click to view similar products for [Standard LEDs - SMD category](#):

Click to view products by [Broadcom manufacturer](#):

Other Similar products are found below :

[LTST-C19GD2WT](#) [LTST-N683GBEW](#) [LTW-170ZDC](#) [LTW-M140SZS40](#) [598-8110-100F](#) [598-8170-100F](#) [598-8610-202F](#) [67-22VRVGC/TR8](#) [AAAF5060QBFSEEZGS](#) [HLMA-QG00-S0021](#) [HLMP-6305-L0011](#) [ALMD-LB36-SV002](#) [APT1608QGW](#) [15-21UYC/S530-A3/TR8](#) [EASV1803BA0](#) [LG M67K-H1J2-24-0-2-R18-Z](#) [LS A676-P2S1-1](#) [SML-512VWT86A](#) [SML-LX0606SISUGC/A](#) [SML-LXL1307SRC-TR](#) [SML-LXR851SIUPGUBC](#) [LT1ED53A](#) [FAT801-S](#) [AM27ZGC03](#) [APB3025SGNC](#) [APFA3010SURKCGKQBDC](#) [APHK1608VGCA](#) [APT2012QGW](#) [CLX6D-FKB-CN1R1H1BB7D3D3](#) [LTST-C250KGKT](#) [LTW-020ZDCG](#) [LTW-21TS5](#) [LTW-220DS5](#) [JANTXM19500/521-02](#) [UYGT801-S](#) [42-21UYC/S530-A3/TR8](#) [LO T67F-V1AB-24-1](#) [YGFR411-H](#) [SML-LX0402IC-TR](#) [CMDA20AYAA7D1S](#) [CMDA16AYDR7A1X](#) [339-1SURSYGW/S530-A2](#) [598-8040-100F](#) [598-8070-100F](#) [598-8140-100F](#) [598-8610-200F](#) [EAPL3527GA5](#) [SML-LXL1209SYC/ATR](#) [EASV3020YGA0](#) [EAST16086YA5](#)