

## ASMC-PxB9-Txxxx

### Envisium™ Power PLCC-4 Surface Mount LED

---

## Overview

The Envisium LED is the premier class of mid-Power LEDs using AlInGaP chip technology. Envisium LEDs offer unparalleled performance, engineering, and design flexibility.

## Description

The Envisium™ Power PLCC-4 SMT LED is an extension of the Broadcom® PLCC-4 SMT LEDs. The package can be driven at high current due to its superior package design. The product is able to dissipate the heat more efficiently compared to the conventional PLCC-2 SMT LEDs. These LEDs produce higher light output with better flux performance compared to the conventional PLCC-4 SMT LEDs.

The Envisium Power PLCC-4 SMT LEDs are designed for higher reliability and better performance, and operate under a wide range of environmental conditions. The performance characteristics of these new mid-power LEDs make them uniquely suitable for use in harsh conditions such as in automotive applications, and in electronics signs and signals.

To facilitate easy pick and place assembly, the LEDs are packed in EIA-compliant tape and reel. Every reel is shipped in single intensity and color bin (except for red), to provide close uniformity. These LEDs are compatible with the IR solder reflow process. Due to the high reliability feature of these products, they also can be mounted using through-the-wave soldering process.

The Envisium Power PLCC-4 SMT LED is available in three colors: red, red-orange, and amber.

## Features

- Industry-standard PLCC-4 (Plastic Leaded Chip Carrier)
- High reliability LED package
- High brightness with optimum flux performance using AlInGaP dice technologies
- Available in Red, Red Orange, and Amber colors
- High optical efficiency
- Higher ambient temperature at the same current possible compared to PLCC-2
- Super wide viewing angle at 120°
- Available in 8-mm carrier tape on 7-inch reel
- Compatible with both IR and TTW soldering process

## Applications

- Interior automotive
  - Instrument panel backlighting
  - Central console backlighting
  - Navigation and audio system
  - Push button backlighting
- Exterior automotive
  - Turn signals
  - Side repeaters
  - CHMSL
  - Rear combination lamp
  - Puddle light
- Electronic signs and signals
  - Channel lettering
  - Contour lighting
  - Indoor variable message sign
- Office automation, home appliances, industrial equipment
  - Front panel backlighting
  - Push button backlighting
  - Display backlighting

# Package Dimensions

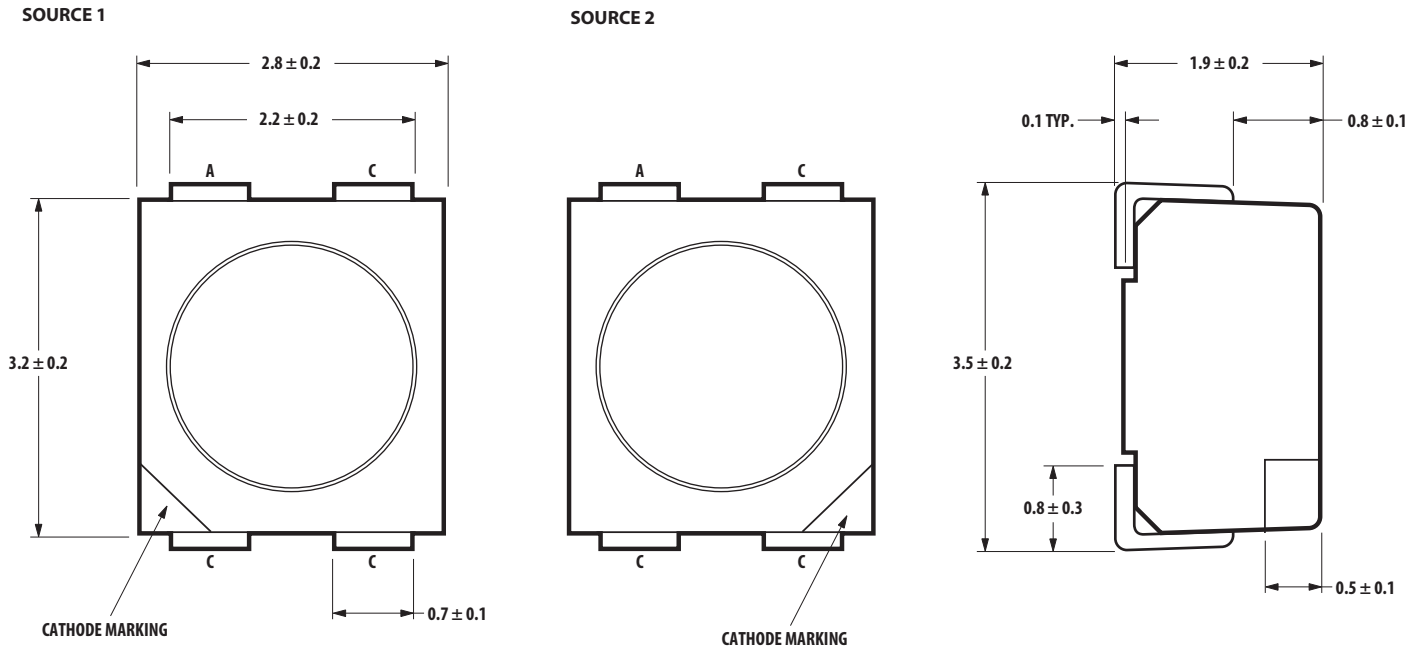

NOTE: ALL DIMENSIONS IN mm.

## Device Selection Guide ( $T_J = 25\text{ }^\circ\text{C}$ )

| Color      | Part Number     | Min. IV (mcd) | Max. IV (mcd) | Test Current (mA) | Dice Technology |
|------------|-----------------|---------------|---------------|-------------------|-----------------|
| Red        | ASMC-PRB9-TV005 | 715.0         | —             | 50                | AllnGaP         |
| Red Orange | ASMC-PHB9-TW005 | 1125.0        | —             | 50                | AllnGaP         |
| Amber      | ASMC-PAB9-TV005 | 715.0         | —             | 50                | AllnGaP         |

**NOTE:**

1. The luminous intensity,  $I_V$ , is measured at the mechanical axis of the lamp package. The actual peak of the spatial radiation pattern may not be aligned with this axis.
2.  $\Phi_V$  is the total luminous flux output as measured with an integrating sphere at mono pulse conditions.
3. Tolerance =  $\pm 12\%$ .

## Part Numbering System

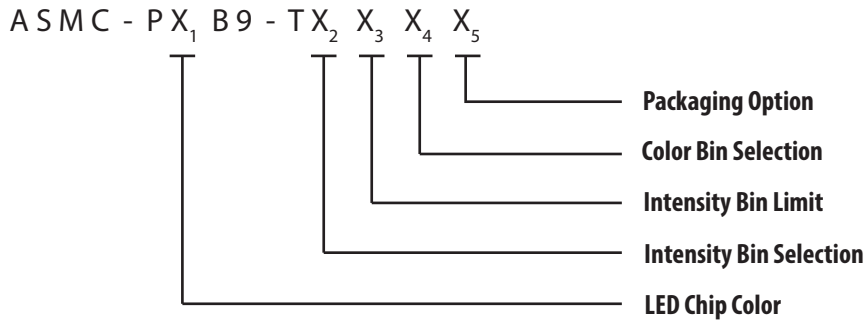

## Absolute Maximum Ratings (T<sub>A</sub> = 25 °C)

| Parameters                        | ASMC-PxB9-Txxxx      |
|-----------------------------------|----------------------|
| DC Forward Current <sup>a</sup>   | 70 mA <sup>b,c</sup> |
| Peak Forward Current <sup>d</sup> | 200 mA               |
| Power Dissipation                 | 240 mW               |
| Reverse Voltage                   | 5V                   |
| Junction Temperature              | 125°C                |
| Operating Temperature             | -40°C to +100°C      |
| Storage Temperature               | -40°C to +100°C      |

- a. Derate linearly as shown in [Figure 4](#).
- b. Drive current between 10 mA and 70 mA is recommended for best long-term performance.
- c. Operation at currents below 5 mA is not recommended.
- d. Duty factor = 10%, frequency = 1 kHz.

## Optical Characteristics ( $T_J = 25\text{ }^\circ\text{C}$ )

| Color      | Part Number     | Dice Technology | Peak Wavelength<br>$\lambda_{\text{PEAK}}$ (nm) | Dominant Wavelength<br>$\lambda_{\text{D}}$ <sup>a</sup> (nm) | Viewing Angle<br>$\theta_{1/2}$ <sup>b</sup><br>(Degrees) | Luminous Efficacy<br>$\eta_V$ <sup>c</sup> (lm/W) | Luminous Intensity/<br>Total Flux<br>$I_V$ (mcd)/ $\Phi_V$ <sup>d</sup> (lm) |
|------------|-----------------|-----------------|---|---|---|---|--|
|            |                 |                 | Typ.  | Typ.  | Typ.  | Typ.  | Typ.   |
| Red        | ASMC-PRB9-Txxx5 | AlInGaP         | 639.0   | 630.0   | 120   | 155   | 0.30   |
| Red Orange | ASMC-PHB9-Txxx5 | AlInGaP         | 623.0   | 617.0   | 120   | 263   | 0.29   |
| Amber      | ASMC-PAB9-Txxx5 | AlInGaP         | 594.0   | 592.0   | 120   | 500   | 0.26   |

- The dominant wavelength,  $\lambda_{\text{D}}$ , is derived from the CIE Chromaticity Diagram and represents the color of the device.
- $\theta_{1/2}$  is the off-axis angle where the luminous intensity is 1/2 the peak intensity.
- Radiant intensity,  $I_e$  in watts/steradian, may be calculated from the equation  $I_e = I_V/\eta_V$ , where  $I_V$  is the luminous intensity in candelas and  $\eta_V$  is the luminous efficacy in lumens/watt.
- $\Phi_V$  is the total luminous flux output as measured with an integrating sphere at mono pulse conditions.

## Electrical Characteristics ( $T_J = 25\text{ }^\circ\text{C}$ )

| Part Number     | Forward Voltage $V_F$ (Volts) at $I_F = 50\text{ mA}$ |      | Reverse Voltage $V_R$ at $100\text{ }\mu\text{A}$ |
|-----------------|---|------|---|
|                 | Typ.  | Max. | Min.  |
| ASMC-PxB9-Txxx5 | 2.8   | 3.4  | 5   |

Figure 1: Relative Intensity vs. Wavelength

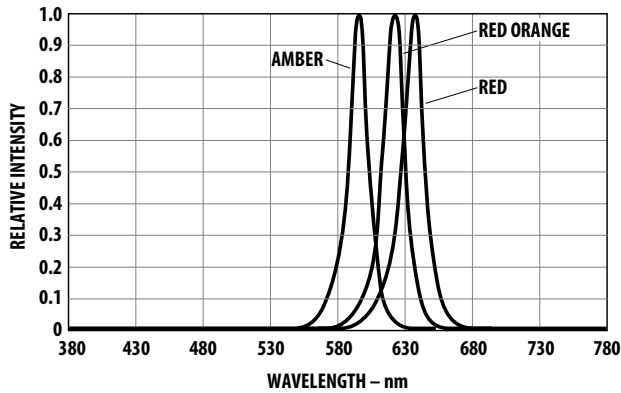

Figure 2: Forward Current vs. Forward Voltage

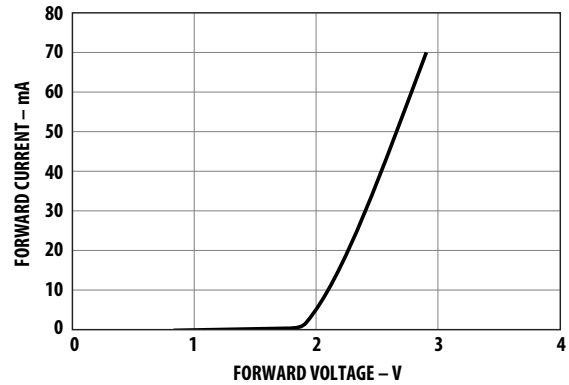

Figure 3: Relative Intensity vs. Forward Current

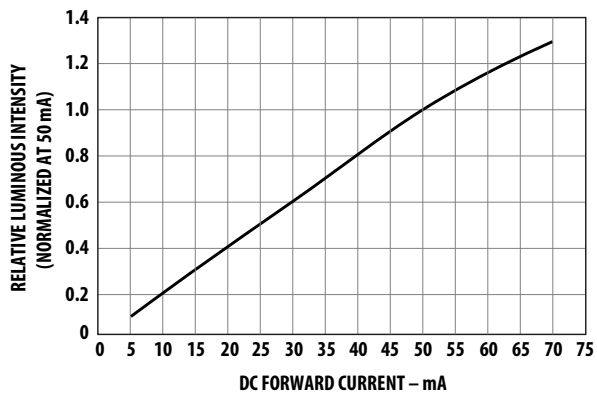

Figure 4: Maximum Forward Current vs. Ambient Temperature (Derated Based on  $T_{JMAX} = 125^{\circ}C$ ,  $R_{\theta JA} = 300^{\circ}C/W$ )

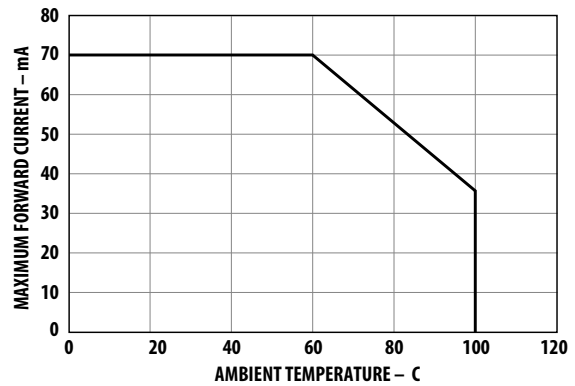

Figure 5: Radiation Pattern

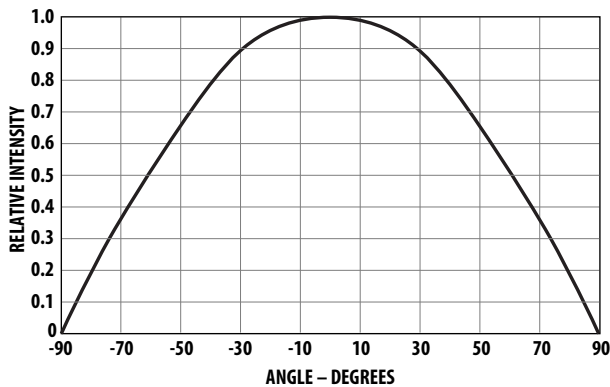
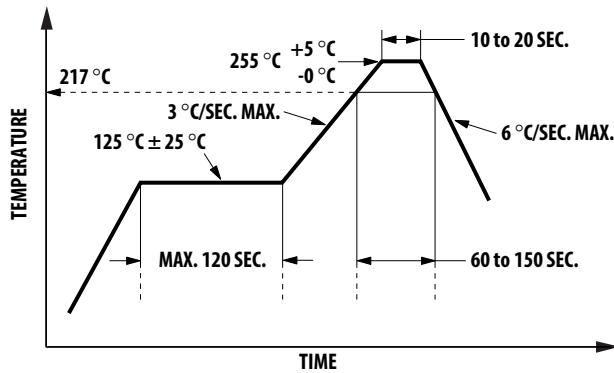

Figure 6: Recommended Pb-Free Reflow Soldering Profile



\* THE TIME FROM 25 °C TO PEAK TEMPERATURE = 6 MINUTES MAX.

For detailed information on reflow soldering of Broadcom surface-mount LEDs, refer to Application Note AN 1060, *Surface Mounting SMD LED Indicator Components*.

Figure 7: Recommended Wave Soldering Profile

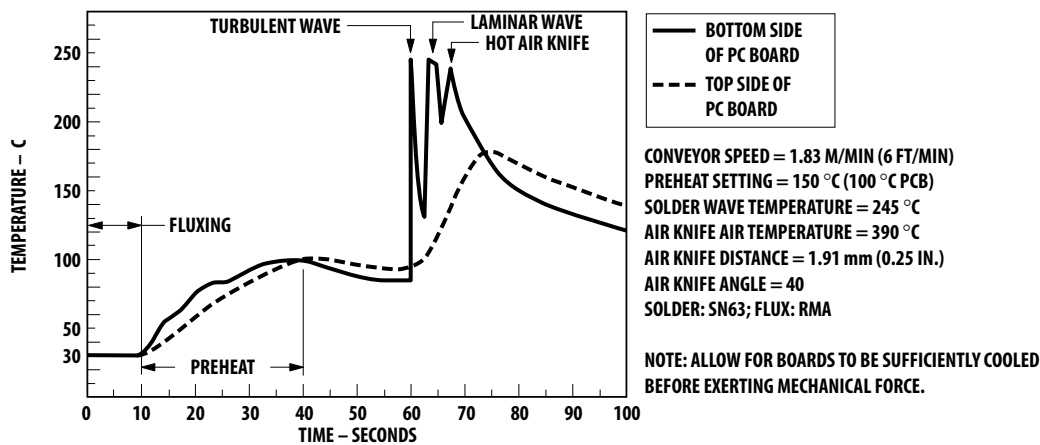

Figure 8: Recommended Soldering Pattern

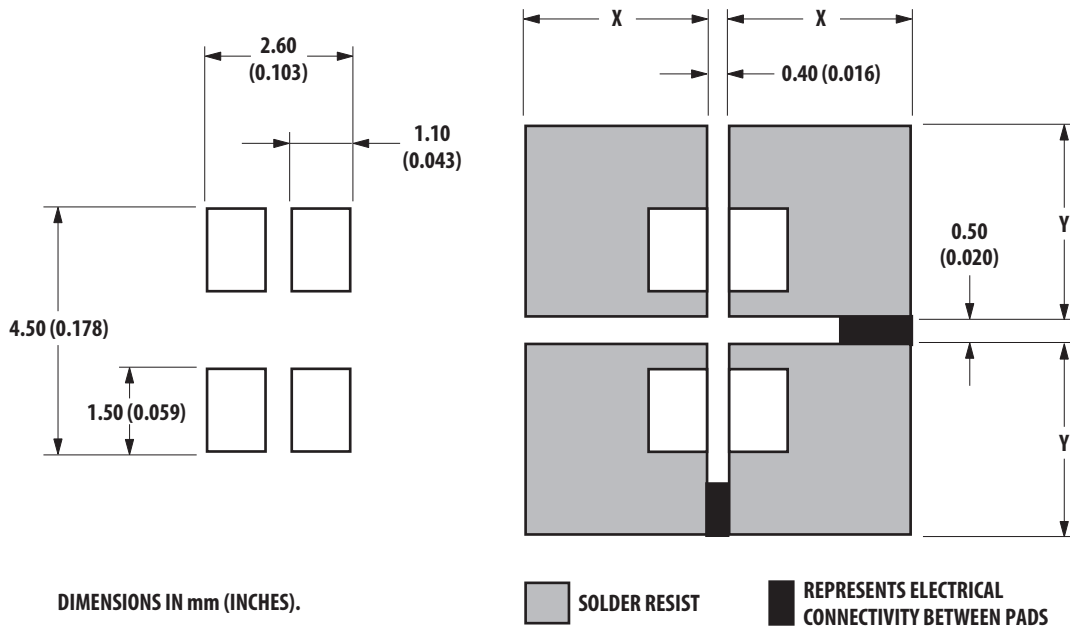
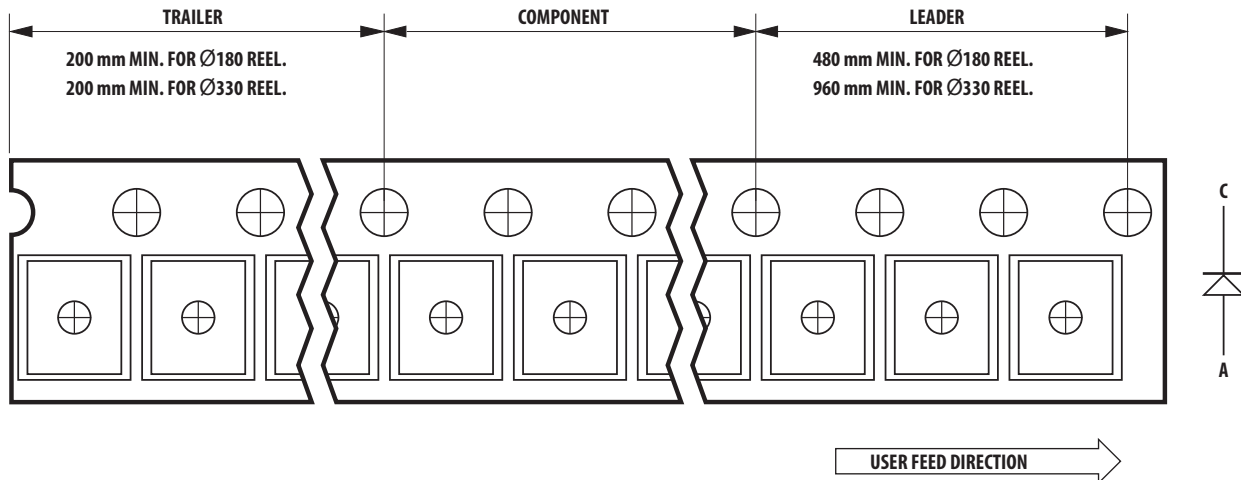

Figure 9: Tape Leader and Trailer Dimensions







## Intensity Bin Select (X<sub>2</sub>X<sub>3</sub>)

Individual reel will contain parts from one half bin only.

| X <sub>2</sub> | Min I <sub>V</sub> Bin                     |
|----------------|--|
|                |  |
| X <sub>3</sub> |  |
| 0              | Full Distribution                          |
| 2              | 2 half bins starting from X <sub>2</sub> 1 |
| 3              | 3 half bins starting from X <sub>2</sub> 1 |
| 4              | 4 half bins starting from X <sub>2</sub> 1 |
| 5              | 5 half bins starting from X <sub>2</sub> 1 |
| 6              | 2 half bins starting from X <sub>2</sub> 2 |
| 7              | 3 half bins starting from X <sub>2</sub> 2 |
| 8              | 4 half bins starting from X <sub>2</sub> 2 |
| 9              | 5 half bins starting from X <sub>2</sub> 2 |

## Intensity Bin Limits and Typical Flux

| Bin ID | Min. (mcd) | Max. (mcd) |
|--------|------------|------------|
| V1     | 715.00     | 900.00     |
| V2     | 900.00     | 1125.00    |
| W1     | 1125.00    | 1400.00    |
| W2     | 1400.00    | 1800.00    |
| X1     | 1800.00    | 2240.00    |
| X2     | 2240.00    | 2850.00    |

Tolerance of each bin limit = ±12%.

## Color Bin Select (X<sub>4</sub>)

Individual reel will contain parts from one full bin only.

| X <sub>4</sub> |                        |
|----------------|------------------------|
| 0              | Full Distribution      |
| A              | 1 and 2 only           |
| B              | 2 and 3 only           |
| C              | 3 and 4 only           |
| D              | 4 and 5 only           |
| E              | 5 and 6 only           |
| G              | 1, 2, and 3 only       |
| H              | 2, 3, and 4 only       |
| J              | 3, 4, and 5 only       |
| K              | 4, 5, and 6 only       |
| M              | 1, 2, 3, and 4 only    |
| N              | 2, 3, 4, and 5 only    |
| P              | 3, 4, 5, and 6 only    |
| R              | 1, 2, 3, 4, and 5 only |
| S              | 2, 3, 4, 5, and 6 only |

## Color Bin Limits

| Amber/Yellow | Min. (nm) | Max. (nm) |
|--------------|-----------|-----------|
| 1            | 582.0     | 584.5     |
| 2            | 584.5     | 587.0     |
| 3            | 587.0     | 589.5     |
| 4            | 589.5     | 592.0     |
| 5            | 592.0     | 594.5     |
| 6            | 594.5     | 597.0     |

| Red Orange | Min. (nm) | Max. (nm) |
|------------|-----------|-----------|
| 1          | 611.0     | 616.0     |
| 2          | 616.0     | 620.0     |

| Red               | Min. (nm) | Max. (nm) |
|-------------------|-----------|-----------|
| Full Distribution |           |           |

Tolerance of each bin limit = ±1 nm.

## Packaging Option (X<sub>5</sub>)

| Option | Test Current | Package Type | Reel Size |
|--------|--------------|--------------|-----------|
| 5      | 50 mA        | Top Mount    | 7 inch    |

## Forward Voltage Bin Table for ASMC-PXB9-Txxxx Only

| Bin | Min. | Max. |
|-----|------|------|
| VA  | 1.9  | 2.2  |
| VB  | 2.2  | 2.5  |
| VC  | 2.5  | 2.8  |
| VD  | 2.8  | 3.1  |
| VE  | 3.1  | 3.4  |

Tolerance of each bin limit =  $\pm 0.05$ .

## Precautionary Notes

### Handling Precautions

For automated pick and place, Broadcom has tested the following nozzle size to be working with this LED. However, due to the possibility of variations in other parameters, such as pick and place machine maker/model and other settings of the machine, the customer should verify that the nozzle selected will not cause damage to the LED.

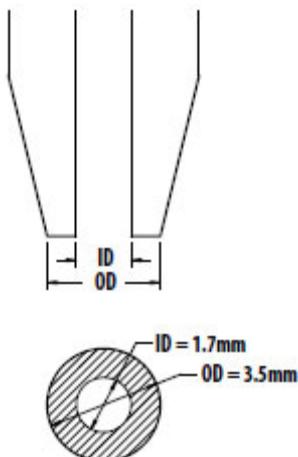

## Handling of Moisture Sensitive Devices

This product has a Moisture Sensitive Level 2a rating per JEDEC J-STD-020. Refer to the Application Note AN5305, *Handling of Moisture Sensitive Surface Mount Devices*, for additional details and a review of proper handling procedures.

- Before use:
  - An unopened moisture barrier bag (MBB) can be stored at  $< 40\text{ }^{\circ}\text{C}/90\%\text{ RH}$  for 12 months. If the actual shelf life has exceeded 12 months and the humidity indicator card (HIC) indicates that baking is not required, it is safe to reflow the LEDs per the original MSL rating.
  - Do not open the MBB prior to assembly (for example, for IQC).
- Control after opening the MBB:
  - Read the HIC immediately upon opening of MBB.
  - The LEDs must be kept at  $< 30\text{ }^{\circ}\text{C} / 60\%\text{ RH}$  at all times and all high temperature-related processes, including soldering, curing, or rework, must be completed within 672 hours.
- Control for unfinished reel:
 

Store unused LEDs in a sealed MBB with desiccant or desiccator at  $< 5\%\text{ RH}$ .
- Control of assembled boards:
 

If the PCB soldered with the LEDs is to be subjected to other high temperature processes, the PCB must be stored in a sealed MBB with desiccant or desiccator at  $< 5\%\text{ RH}$  to ensure that all LEDs have not exceeded their floor life of 168 hours.
- Baking is required if:
  - The HIC indicator is not BROWN at 10% and is AZURE at 5%.
  - The LEDs are exposed to condition of  $> 30\text{ }^{\circ}\text{C}/60\%\text{ RH}$  at any time.
  - The LED floor life exceeded 168 hrs.

The recommended baking condition is  $60 \pm 5\text{ }^{\circ}\text{C}$  for 20 hrs.

Baking should only be done once.
- Storage:
 

The soldering terminals of these Broadcom LEDs are silver plated. If the LEDs are exposed in ambient environment for too long, the silver plating might become oxidized, which affects its solderability performance. As such, keep unused LEDs in a sealed MBB with desiccant or in desiccator at  $< 5\%\text{ RH}$ .

## Application Precautions

- The drive current of the LED must not exceed the maximum allowable limit across temperature as stated in the data sheet. Constant current driving is recommended to ensure consistent performance.
- LEDs exhibit slightly different characteristics at different drive currents that might result in larger variations in their performance (that is, intensity, wavelength and forward voltage). Set the application current as close as possible to the test current to minimize these variations.
- The LED is not intended for reverse bias. Use other appropriate components for such purposes. When driving the LED in matrix form, ensure that the reverse bias voltage does not exceed the allowable limit of the LED.
- Do not use the LED in the vicinity of materials with sulfur content, such as environment of high gaseous sulfur compounds and corrosive elements. Examples of material that may contain sulfur are rubber gasket, RTV (room temperature vulcanizing) silicone rubber, rubber gloves, and so on. Prolonged exposure to such environments might affect the optical characteristics and product life.
- Avoid rapid change in ambient temperature, especially in high humidity environments because they will cause condensation on the LED.
- Although the LED is rated as IPx6 according to IEC60529: Degree of protection provided by enclosure, the test condition may not represent actual exposure during application. If the LED is intended to be used in outdoor or harsh environments, the LED must be protected against damages caused by rain water, dust, oil, corrosive gases, external mechanical stress and so on.

## Thermal Management

Optical, electrical, and reliability characteristics of the LED are affected by temperature. Keep the junction temperature ( $T_J$ ) of the LED below the allowable limit at all times.  $T_J$  can be calculated as below:

$$T_J = T_A + R_{\theta J-A} \times I_F \times V_{Fmax}$$

where:

$T_A$  = Ambient temperature ( $^{\circ}\text{C}$ )

$R_{\theta J-A}$  = Thermal resistance from LED junction to ambient ( $^{\circ}\text{C}/\text{W}$ )

$I_F$  = Forward current (A)

$V_{Fmax}$  = Maximum forward voltage (V)

The complication of using this formula lies in  $T_A$  and  $R_{\theta J-A}$ . Actual  $T_A$  is sometimes subjective and hard to determine.  $R_{\theta J-A}$  varies from system to system depending on design and is usually not known.

Another way of calculating  $T_J$  is by using solder point temperature  $T_S$  as follows:

$$T_J = T_S + R_{\theta J-S} \times I_F \times V_{Fmax}$$

where:

$T_S$  = LED solder point temperature as shown in the following illustration ( $^{\circ}\text{C}$ )

$R_{\theta J-S}$  = Thermal resistance from junction to solder point ( $^{\circ}\text{C}/\text{W}$ )

Source 1

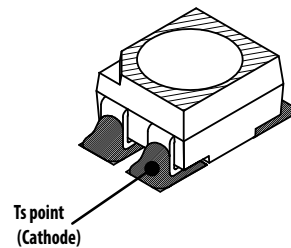

Source 2

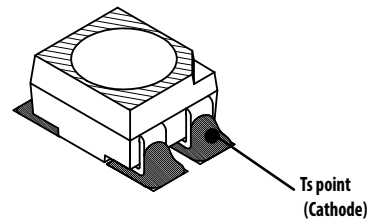

$T_S$  can be measured easily by mounting a thermocouple on the soldering joint as shown in the preceding illustration, while  $R_{\theta J-S}$  is provided in the data sheet. Verify the  $T_S$  of the LEDs in the final product to ensure that the LEDs are operated within all maximum ratings stated in this data sheet.

## Eye Safety Precautions

LEDs can pose optical hazards when in operation. Do not look directly at operating LEDs because doing so might be harmful to the eyes. For safety reasons, use appropriate shielding or personal protective equipment.

## Disclaimer

Broadcom's products and software are not specifically designed, manufactured, or authorized for sale as parts, components, or assemblies for the planning, construction, maintenance, or direct operation of a nuclear facility or for use in medical devices or applications. The customer is solely responsible, and waives all rights to make claims against Broadcom or its suppliers, for all loss, damage, expense, or liability in connection with such use.

Broadcom, the pulse logo, Connecting everything, Avago Technologies, Avago, and the A logo are among the trademarks of Broadcom and/or its affiliates in the United States, certain other countries, and/or the EU.

Copyright © 2015–2020 Broadcom. All Rights Reserved.

The term “Broadcom” refers to Broadcom Inc. and/or its subsidiaries. For more information, please visit [www.broadcom.com](http://www.broadcom.com).

Broadcom reserves the right to make changes without further notice to any products or data herein to improve reliability, function, or design. Information furnished by Broadcom is believed to be accurate and reliable. However, Broadcom does not assume any liability arising out of the application or use of this information, nor the application or use of any product or circuit described herein, neither does it convey any license under its patent rights nor the rights of others.



Lead (Pb) Free  
RoHS Compliant

## X-ON Electronics

Largest Supplier of Electrical and Electronic Components

*Click to view similar products for [Standard LEDs - SMD category](#):*

*Click to view products by [Broadcom manufacturer](#):*

Other Similar products are found below :

[LTST-C19GD2WT](#) [LTST-N683GBEW](#) [LTW-170ZDC](#) [LTW-M140SZS40](#) [598-8110-100F](#) [598-8170-100F](#) [598-8610-202F](#) [67-22VRVGC/TR8](#) [AAAF5060QBFSEEZGS](#) [HLMP-6305-L0011](#) [ALMD-LB36-SV002](#) [APT1608QGW](#) [15-21UYC/S530-A3/TR8](#) [EASV1803BA0](#) [LG M67K-H1J2-24-0-2-R18-Z](#) [LS A676-P2S1-1](#) [SML310BATT86](#) [SML-512VWT86A](#) [SML-LX0606SISUGC/A](#) [SML-LXL1307SRC-TR](#) [SML-LXR851SIUPGUBC](#) [LT1ED53A](#) [FAT801-S](#) [AM27ZGC03](#) [APB3025SGNC](#) [APFA3010SURKCGKQBDC](#) [APHK1608VGCA](#) [APT2012QGW](#) [CLX6D-FKB-CN1R1H1BB7D3D3](#) [LTST-C250KGKT](#) [LTW-020ZDCG](#) [LTW-21TS5](#) [LTW-220DS5](#) [JANTXM19500/521-02](#) [UYGT801-S](#) [42-21UYC/S530-A3/TR8](#) [LO T67F-V1AB-24-1](#) [YGFR411-H](#) [SML-LX0402IC-TR](#) [CMDA20AYAA7D1S](#) [CMDA16AYDR7A1X](#) [339-1SURSYGW/S530-A2](#) [598-8040-100F](#) [598-8070-100F](#) [598-8140-100F](#) [598-8610-200F](#) [EAPL3527GA5](#) [67-11/BHC-M1N2B8Y/2A0](#) [SML-LXL1209SYC/ATR](#) [EASV3020YGA0](#)