

## **ASMM-Cx03-xxxxx**

### **PLCC-2 Surface Mount LED**

---

#### **Description**

The Broadcom<sup>®</sup> ASMM-Cx03 Surface Mount LED is packaged in the industry-standard PLCC-2 package and has high-reliability performance designed to work under a wide range of environmental conditions. This high-reliability feature makes them ideally suited to be used for wide range of applications.

The wide viewing angle at 120° makes these LEDs ideally suited for panel, push button, or general backlighting in office equipment, industrial equipment, and home appliances. The flat top emitting surface makes it easy for these LEDs to integrate with light pipes. With the built-in reflector enhancing the light output intensity, these LEDs are also suitable to be used as LED pixels in indoor electronic signs.

To facilitate easy pick and place assembly, the LEDs are packed in tape and reel form. Every reel is shipped in single intensity and color bin to provide close uniformity.

#### **Features**

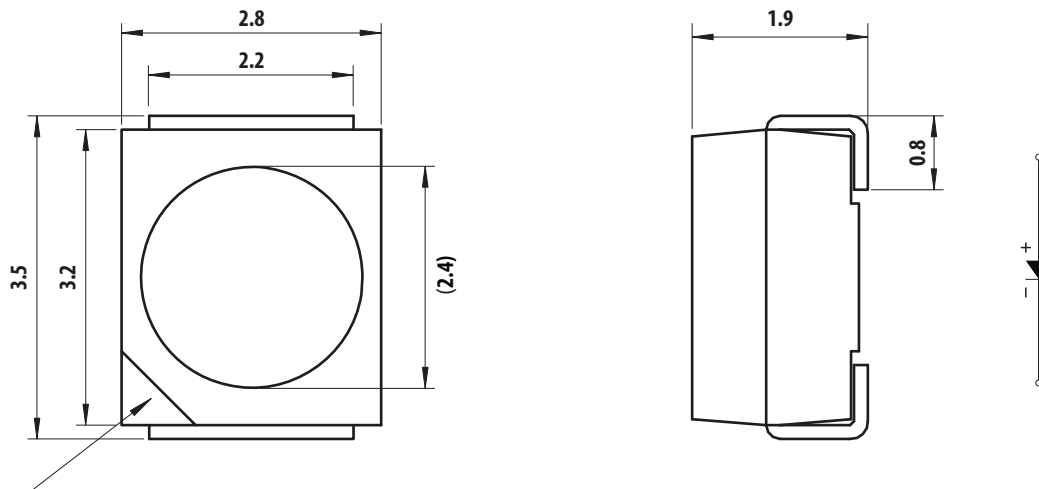
- Industry-standard PLCC-2 package.
- High-reliability LED package with enhanced silicone resin encapsulation.
- High brightness using AlGaAs, GaP, and AlInGaP dice technologies.
- Available in full selection of colors.
- Wide angle viewing angle at 120°.
- JEDEC MSL 3.

#### **Applications**

- Electronic signs and signals.
- Office automations, home appliances, and industrial equipment.
  - Front panel backlighting
  - Push button backlighting
  - Display backlighting
  - Scanner lighting

**CAUTION!** This LED is ESD sensitive. Please observe appropriate precautions during handling and processing. Refer to application note AN-1142 for additional details.

Figure 1: Package Drawing



CATHODE MARK (ANODE MARK FOR AlGaAs AND ASMM-CR03-Bxxxx2)

**NOTE:**

1. Dimensions in bracket are for reference only.
2. Tolerance is  $\pm 0.20$  mm unless otherwise specified.
3. Encapsulation = silicone.
4. Terminal finish = silver plating.
5. All dimensions in millimeters (mm).

## Device Selection Guide ( $T_J = 25^\circ\text{C}$ )

Part Number	Color	Luminous Intensity, $I_V$ (mcd) <sup>a, b</sup>			Luminous Flux, $\Phi_V$ (lm) <sup>c</sup>	Test Current (mA)	Dice Technology
		Min.	Typ.	Max.	Typ.		
ASMM-CS03-HM002	Super Red	18.0	40.0	—	114.3	20	AlGaAs
ASMM-CS03-HN402	Super Red	28.5	45.0	71.5	128.6	20	AlGaAs
ASMM-CR03-GJ002	Red	4.5	12.0	—	34.3	20	GaP
ASMM-CR03-AS402	Red	180.0	220.0	450.0	594.6	20	AllnGaP
ASMM-CR03-BU602	Red	560.0	750.0	900.0	2027.1	20	AllnGaP
ASMM-CR03-BU802	Red	560.0	750.0	1400.0	2027.1	20	AllnGaP
ASMM-CR03-BV302	Red	715.0	850.0	1400.0	2297.3	20	AllnGaP
ASMM-CH03-AS402	Red-Orange	180.0	225.0	450.0	608.1	20	AllnGaP
ASMM-CJ03-GL002	Orange	11.2	15.0	—	42.9	20	GaP
ASMM-CJ03-AS402	Orange	180.0	350.0	450.0	945.9	20	AllnGaP
ASMM-CA03-GK002	Amber	7.2	15.0	—	40.5	20	GaP
ASMM-CA03-AR402	Amber	112.5	165.0	285.0	445.9	20	AllnGaP
ASMM-CA03-AS402	Amber	180.0	200.0	450.0	540.5	20	AllnGaP
ASMM-CA03-AR8C2	Amber	140.0	180.0	355.0	486.5	20	AllnGaP
ASMM-CF03-GL8M2	Yellow-Green	14.0	28.0	35.5	75.7	20	GaP
ASMM-CF03-GK7M1	Yellow-Green	9.0	14.0	18.0	37.8	10	GaP
ASMM-CF03-AQ3B2	Yellow-Green	71.5	85.0	140.0	229.7	20	AllnGaP
ASMM-CF03-AP402	Yellow-Green	45.0	65.0	112.5	175.7	20	AllnGaP
ASMM-CF03-AQ6M2	Yellow-Green	90.0	100.0	140.0	270.3	20	AllnGaP

a. The luminous intensity,  $I_V$  is measured at the mechanical axis of the LED package at a single current pulse condition. The actual peak of the spatial radiation pattern may not be aligned with the axis.

b. Luminous intensity tolerance =  $\pm 12\%$ .

c. Values are for reference only.

## Absolute Maximum Ratings

Parameter	GaP and AlGaAs	AllnGaP	Unit
DC Forward Current <sup>a</sup>	30	30	mA
Peak Forward Current <sup>b</sup>	100	100	mA
Power Dissipation	78	78	mW
LED Junction Temperature	110		$^\circ\text{C}$
Operating Temperature Range	-40 to +100		$^\circ\text{C}$
Storage Temperature Range	-40 to +100		$^\circ\text{C}$

a. Derate linearly as shown in [Figure 18](#), [Figure 19](#), and [Figure 20](#).

b. Duty factor = 10%, frequency = 1 kHz.

## Optical Characteristics ( $T_J = 25^\circ\text{C}$ )

Part Number	Color	Peak Wavelength, $\lambda_p$ (nm)	Dominant Wavelength, $\lambda_d$ (nm) <sup>a</sup>	Viewing Angle, $2\theta_{1/2}$ ( $^\circ$ ) <sup>b</sup>	Test Current (mA)	Dice Technology
		Typ.	Typ.	Typ.		
ASMM-CS03-HM002	Super Red	645	637	120	20	AlGaAs
ASMM-CS03-HN402	Super Red	645	637	120	20	AlGaAs
ASMM-CR03-GJ002	Red	635	628	120	20	GaP
ASMM-CR03-AS402	Red	630	625	120	20	AllnGaP
ASMM-CR03-BU602	Red	630	625	120	20	AllnGaP
ASMM-CR03-BU802	Red	630	625	120	20	AllnGaP
ASMM-CR03-BV302	Red	630	625	120	20	AllnGaP
ASMM-CH03-AS402	Red-Orange	626	618	120	20	AllnGaP
ASMM-CJ03-GL002	Orange	604	602	120	20	GaP
ASMM-CJ03-AS402	Orange	609	605	120	20	AllnGaP
ASMM-CA03-GK002	Amber	590	588	120	20	GaP
ASMM-CA03-AR402	Amber	590	588	120	20	AllnGaP
ASMM-CA03-AS402	Amber	590	588	120	20	AllnGaP
ASMM-CA03-AR8C2	Amber	590	588	120	20	AllnGaP
ASMM-CF03-GL8M2	Yellow-Green	566	570	120	20	GaP
ASMM-CF03-GK7M1	Yellow-Green	566	570	120	10	GaP
ASMM-CF03-AQ3B2	Yellow-Green	572	570	120	20	AllnGaP
ASMM-CF03-AP402	Yellow-Green	572	570	120	20	AllnGaP
ASMM-CF03-AQ6M2	Yellow-Green	572	570	120	20	AllnGaP

a. The dominant wavelength,  $\lambda_d$ , is derived from the CIE Chromaticity Diagram and represents the color of the device.

b.  $\theta_{1/2}$  is the off-axis angle where the luminous intensity is  $1/2$  the peak intensity.

## Electrical Characteristics ( $T_J = 25^\circ\text{C}$ )

Part Number	Color	Forward Voltage, $V_F$ (V) <sup>a</sup>			Reverse Voltage, $V_R$ (V) at $I_R = 100 \mu\text{A}$ <sup>b</sup>	Thermal Resistance, $R_{\theta J-S}$ ( $^\circ\text{C}/\text{W}$ ) <sup>c</sup>	Test Current (mA)	Dice Technology
		Min.	Typ.	Max.	Min.	Typ.		
ASMM-CS03-HM002	Super Red	1.7	2.1	2.6	5	130	20	AlGaAs
ASMM-CS03-HN402	Super Red	1.7	2.1	2.6	5	130	20	AlGaAs
ASMM-CR03-GJ002	Red	1.7	2.1	2.6	5	270	20	GaP
ASMM-CR03-AS402	Red	1.7	2.0	2.6	5	220	20	AllnGaP
ASMM-CR03-BU602	Red	1.7	2.2	2.6	5	100	20	AllnGaP
ASMM-CR03-BU802	Red	1.7	2.2	2.6	5	100	20	AllnGaP
ASMM-CR03-BV302	Red	1.7	2.2	2.6	5	100	20	AllnGaP
ASMM-CH03-AS402	Red-Orange	1.7	2.0	2.6	5	100	20	AllnGaP
ASMM-CJ03-GL002	Orange	1.7	2.1	2.6	5	220	20	GaP
ASMM-CJ03-AS402	Orange	1.7	2.0	2.6	5	190	20	AllnGaP
ASMM-CA03-GK002	Amber	1.7	2.2	2.6	5	340	20	GaP
ASMM-CA03-AR402	Amber	1.7	2.0	2.6	5	190	20	AllnGaP
ASMM-CA03-AS402	Amber	1.7	2.0	2.6	5	190	20	AllnGaP
ASMM-CA03-AR8C2	Amber	1.7	2.0	2.6	5	190	20	AllnGaP
ASMM-CF03-GL8M2	Yellow-Green	1.7	2.2	2.6	5	210	20	GaP
ASMM-CF03-GK7M1	Yellow-Green	1.7	2.0	2.6	5	210	10	GaP
ASMM-CF03-AQ3B2	Yellow-Green	1.7	2.0	2.6	5	270	20	AllnGaP
ASMM-CF03-AP402	Yellow-Green	1.7	2.0	2.6	5	270	20	AllnGaP
ASMM-CF03-AQ6M2	Yellow-Green	1.7	2.0	2.6	5	270	20	AllnGaP

a. Forward voltage,  $V_F$  tolerance:  $\pm 0.1\text{V}$ .

b. Indicates product final test condition only. Long-term reverse bias is not recommended.

c. Thermal resistance from LED junction to solder point.

## Part Numbering System

A S M M - C x<sub>1</sub> 0 3 - x<sub>2</sub> x<sub>3</sub> x<sub>4</sub> x<sub>5</sub> x<sub>6</sub>

Code	Description	Option
x1	Color	A Amber
		F Yellow-Green
		H Red-Orange
		J Orange
		R Red
		S Super Red
x2	Dice Technology	A AllnGaP
		B AllnGaP
		G GaP
		H AlGaAs
x3	Minimum Intensity Bin	Refer to <a href="#">Intensity Bin Limits (CAT)</a> table.
x4	Number Of Half Bins	0 Full Distribution
		2 2 half bins starting from (x3)1
		3 3 half bins starting from (x3)1
		4 4 half bins starting from (x3)1
		5 5 half bins starting from (x3)1
		6 2 half bins starting from (x3)2
		7 3 half bins starting from (x3)2
		8 4 half bins starting from (x3)2
		9 5 half bins starting from (x3)2
		x5
A 1 and 2 only		
B 2 and 3 only		
C 3 and 4 only		
D 4 and 5 only		
E 5 and 6 only		
G 1, 2, and 3 only		
H 2, 3, and 4 only		
J 3, 4, and 5 only		
K 4, 5, and 6 only		
M 1, 2, 3, and 4 only		
N 2, 3, 4, and 5 only		
P 3, 4, 5, and 6 only		
R 1, 2, 3, 4, and 5 only		
S 2, 3, 4, 5, and 6 only		
Z Special Color Bin		
x6	Test Option	1 Test current = 10 mA
		2 Test current = 20 mA

## Part Number Example

ASMM-CA03-AR8C2

- $x_1$  : A — Amber
- $x_2$  : A — AlInGaP
- $x_3, x_4$  : R, 8 — 4 half bins from intensity bin R2 (R2, S1, S2, and T1)
- $x_5$  : C — Color bins 3 and 4 only
- $x_6$  : 2 — Test current = 20 mA

## Bin Information

### Intensity Bin Limits (CAT)

Bin ID	Luminous Intensity, $I_v$ (mcd)	
	Min.	Max.
J1	4.5	5.6
J2	5.6	7.2
K1	7.2	9.0
K2	9.0	11.2
L1	11.2	14.0
L2	14.0	18.0
M1	18.0	22.4
M2	22.4	28.5
N1	28.5	35.5
N2	35.5	45.0
P1	45.0	56.0
P2	56.0	71.5
Q1	71.5	90.0
Q2	90.0	112.5
R1	112.5	140.0
R2	140.0	180.0
S1	180.0	224.0
S2	224.0	285.0
T1	285.0	355.0
T2	355.0	450.0
U1	450.0	560.0
U2	560.0	715.0
V1	715.0	900.0
V2	900.0	1125.0
W1	1125.0	1400.0
W2	1400.0	1800.0

### Color Bin Limits (BIN)

Bin ID	Dominant Wavelength, $\lambda_d$ (nm)	
	Min.	Max.
<b>Yellow Green</b>		
1	564.5	567.5
2	567.5	570.5
3	570.5	573.5
4	573.5	576.5
<b>Amber</b>		
2	583.0	586.0
3	586.0	589.0
4	589.0	592.0
5	592.0	595.0
6	595.0	598.0
<b>Orange</b>		
1	597.0	600.0
2	600.0	603.0
3	603.0	606.0
4	606.0	609.0
5	609.0	612.0
<b>Red-Orange</b>		
1	611.0	616.0
2	616.0	620.0
3	620.0	625.0
<b>Red</b>		
0	618.0	635.0
<b>Super Red</b>		
0	635.0	650.0

Tolerance =  $\pm 1$  nm.

Example of bin information on reel and packaging label:

CAT : R2      —      Intensity bin R2

BIN : 2        —      Color bin 2



Figure 2: Relative Intensity vs. Wavelength for GaP and AlGaAs

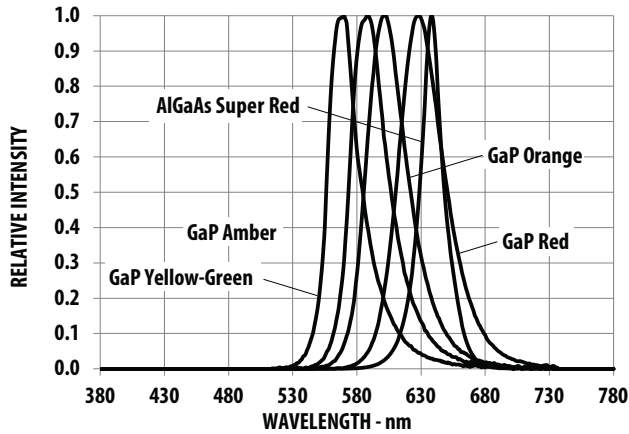


Figure 3: Relative Intensity vs. Wavelength for AlInGaP

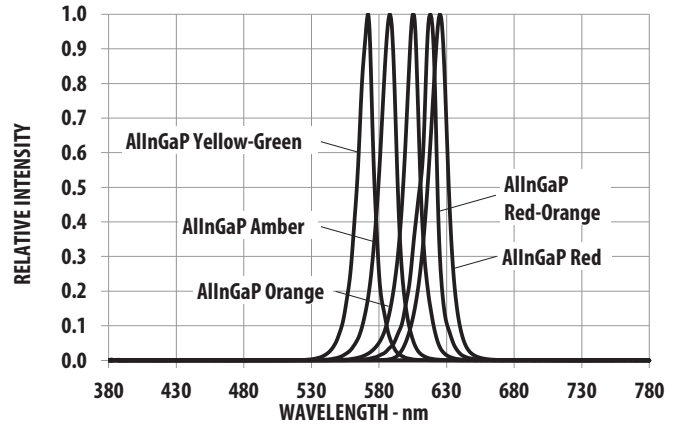


Figure 4: Forward Current vs. Forward Voltage for GaP and AlGaAs

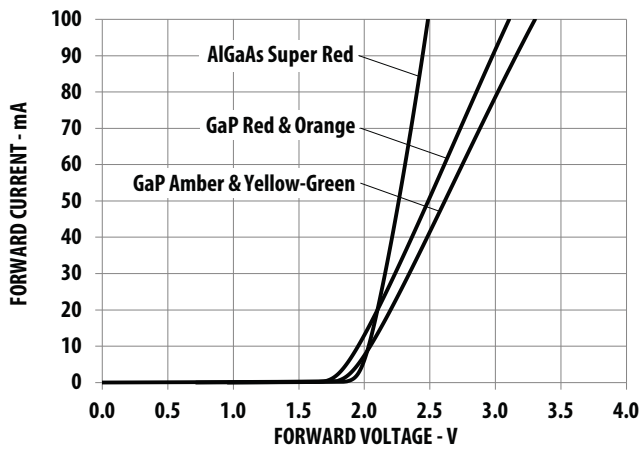


Figure 5: Forward Current vs. Forward Voltage for AlInGaP

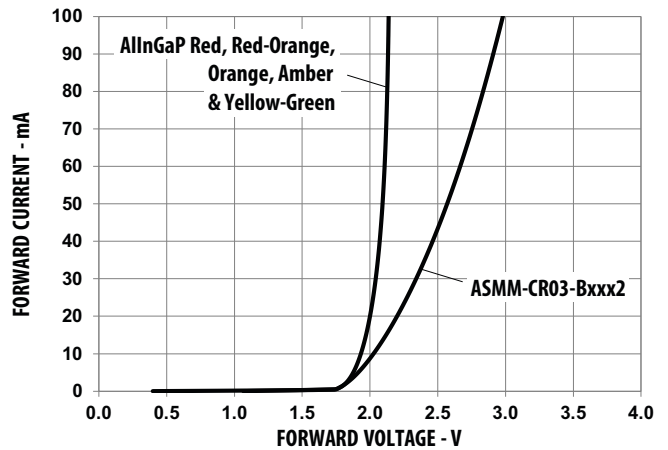


Figure 6: Relative Luminous Intensity vs. Forward Current for GaP, AlGaAs, and AlInGaP (except ASMM-CF03-Gxxx1)

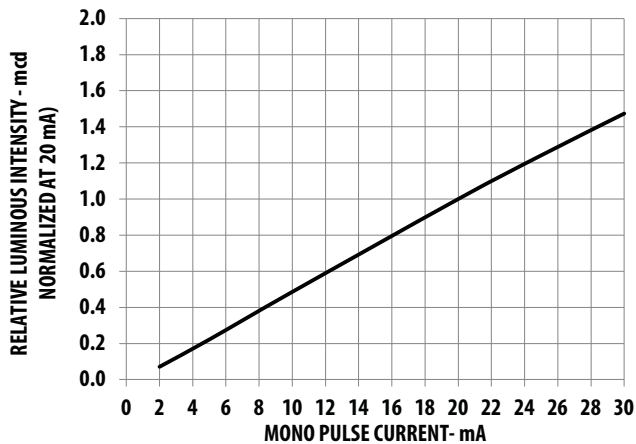


Figure 7: Relative Luminous Intensity vs. Forward Current for ASMM-CF03-Gxxx1

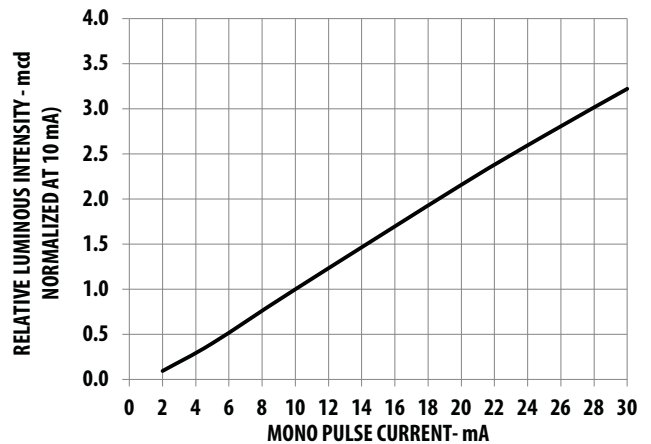


Figure 8: Dominant Wavelength Shift vs. Forward Current for GaP and AlGaAs (except ASMM-CF03-Gxxx1)

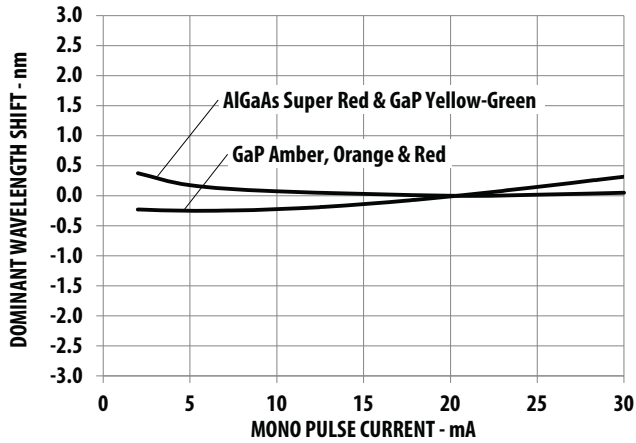


Figure 9: Dominant Wavelength Shift vs. Forward Current for ASMM-CF03-Gxxx1

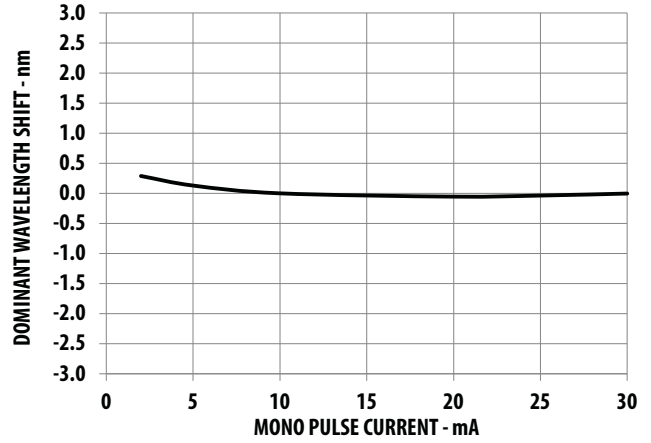


Figure 10: Dominant Wavelength Shift vs. Forward Current for AlInGaP

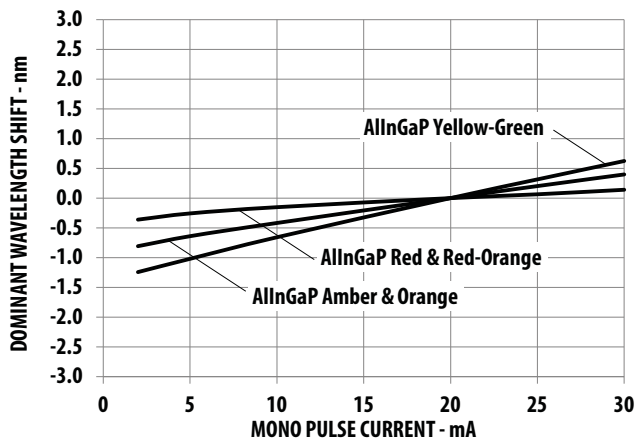


Figure 11: Relative Light Output vs. Junction Temperature for GaP and AlGaAs

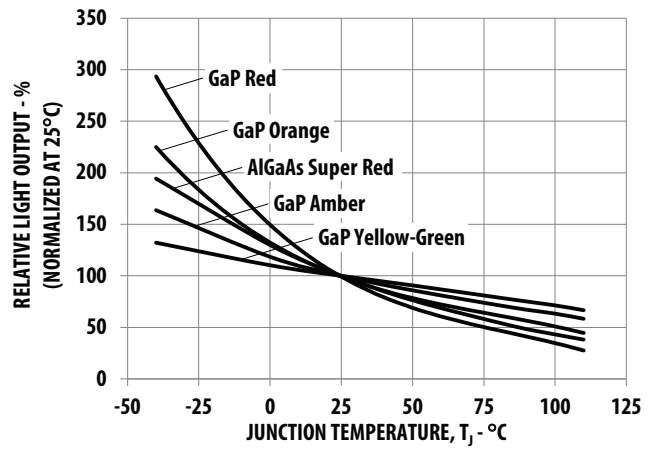


Figure 12: Relative Light Output vs. Junction Temperature for AlInGaP

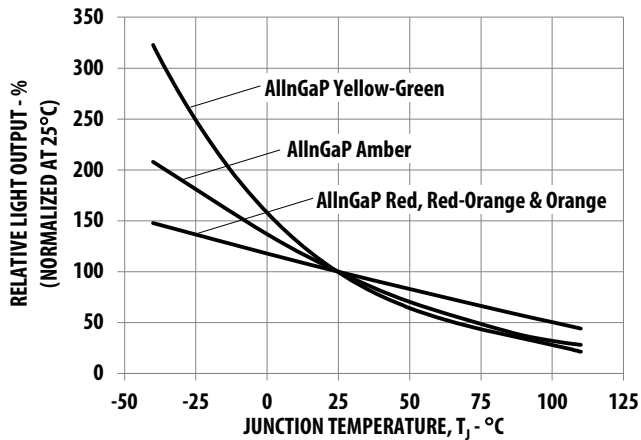


Figure 13: Forward Voltage Shift vs. Junction Temperature for GaP and AlGaAs

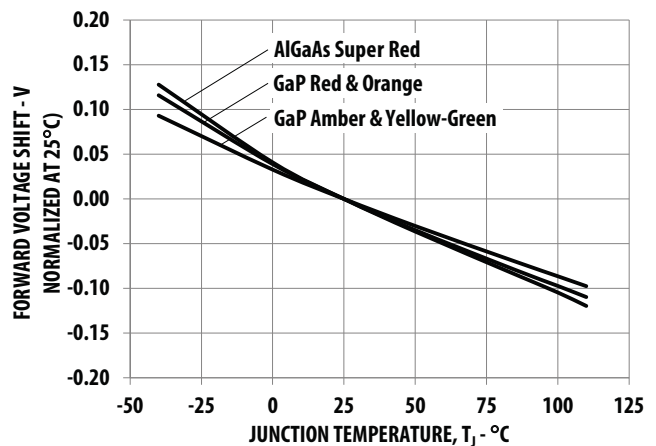


Figure 14: Forward Voltage Shift vs. Junction Temperature for AlInGaP

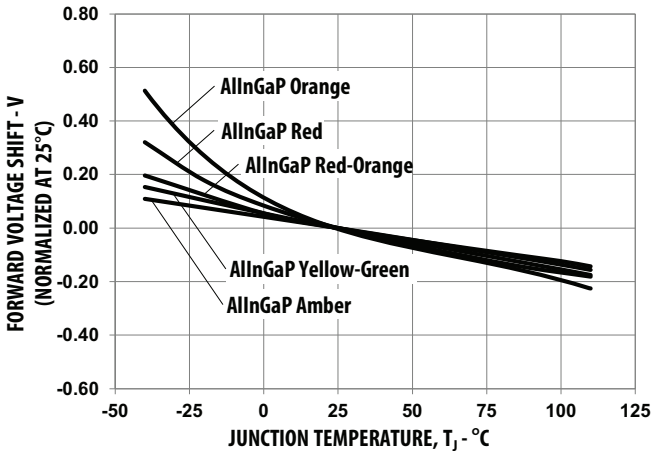


Figure 15: Dominant Wavelength Shift vs. Junction Temperature for GaP and AlGaAs

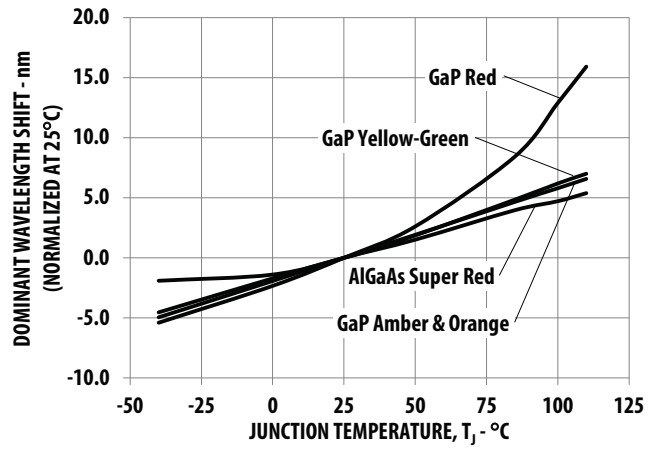


Figure 16: Dominant Wavelength Shift vs. Junction Temperature for AlInGaP

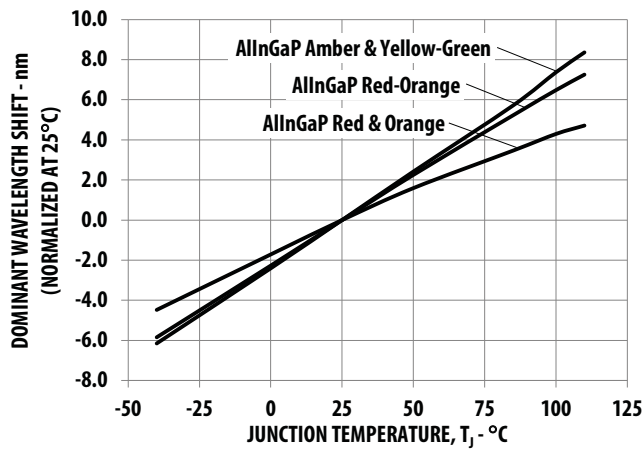


Figure 17: Radiation Pattern

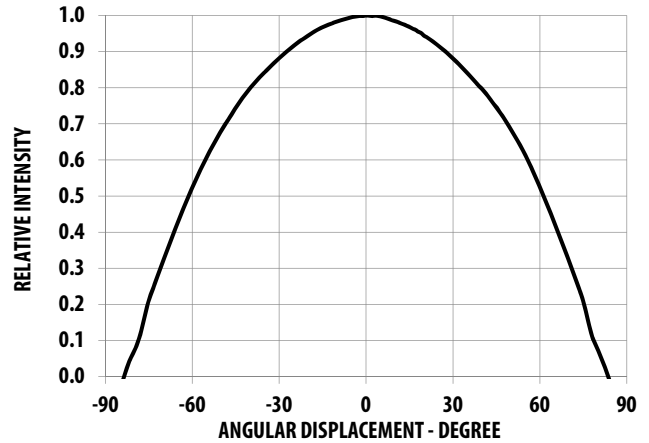


Figure 18: Maximum Forward Current vs. Ambient Temperature for GaP & AlGaAs (Derated based on  $T_{JMAX} = 110\text{ °C}$ ,  $R_{\theta J-A} = 800\text{ °C/W}$ )

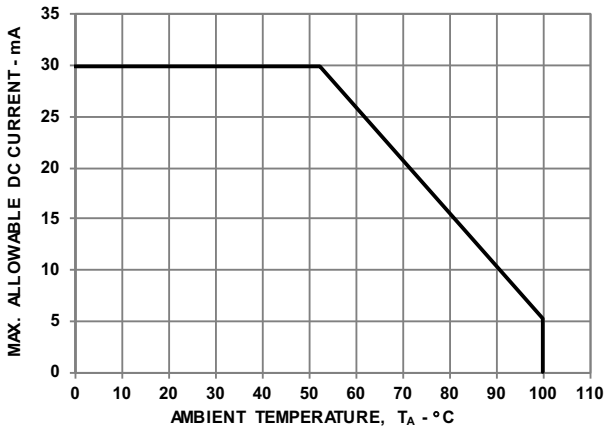
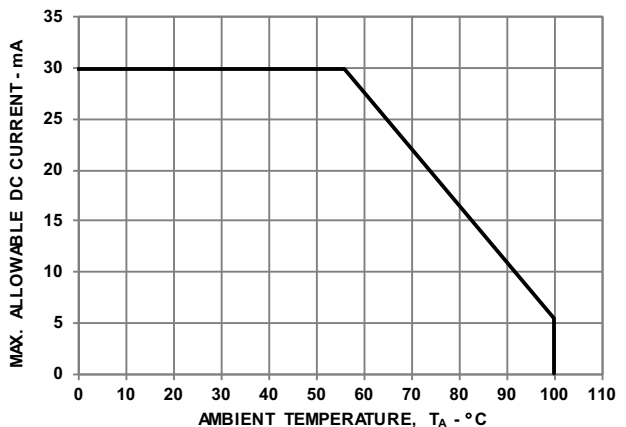
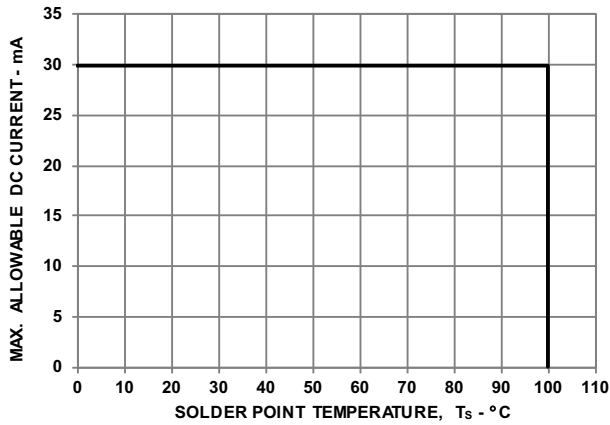


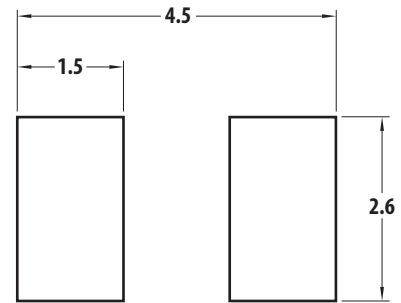
Figure 19: Maximum Forward Current vs. Ambient Temperature for AlInGaP (Derated based on  $T_{JMAX} = 110\text{ °C}$ ,  $R_{\theta J-A} = 750\text{ °C/W}$ )



**Figure 20: Maximum Forward Current vs. Solder Point Temperature (Derated based on  $T_{JMAX} = 110\text{ }^{\circ}\text{C}$ )**

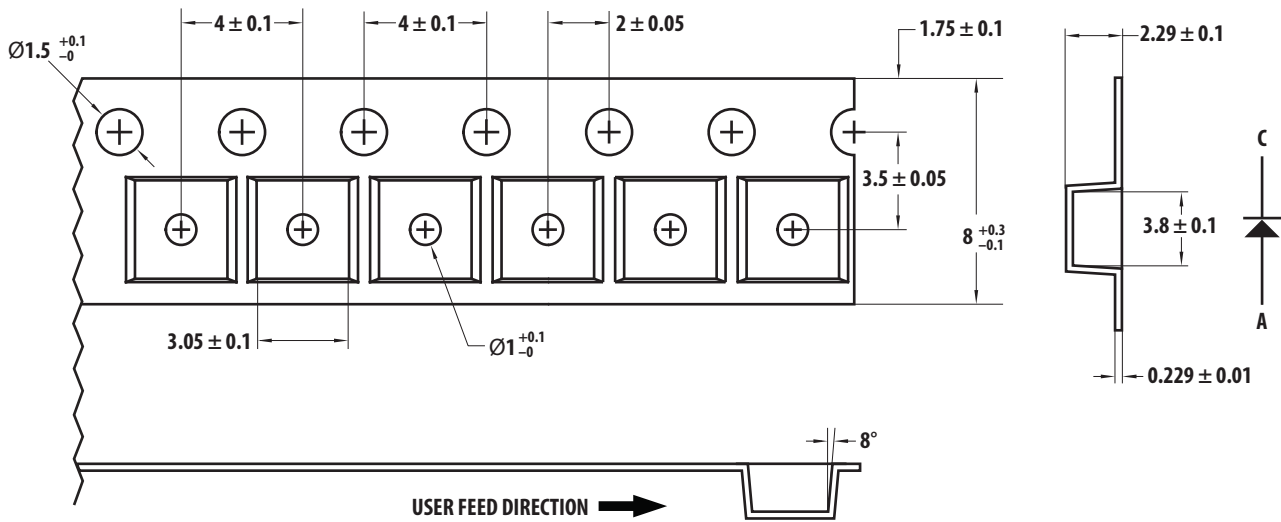


**Figure 21: Recommended Soldering Pad Pattern**



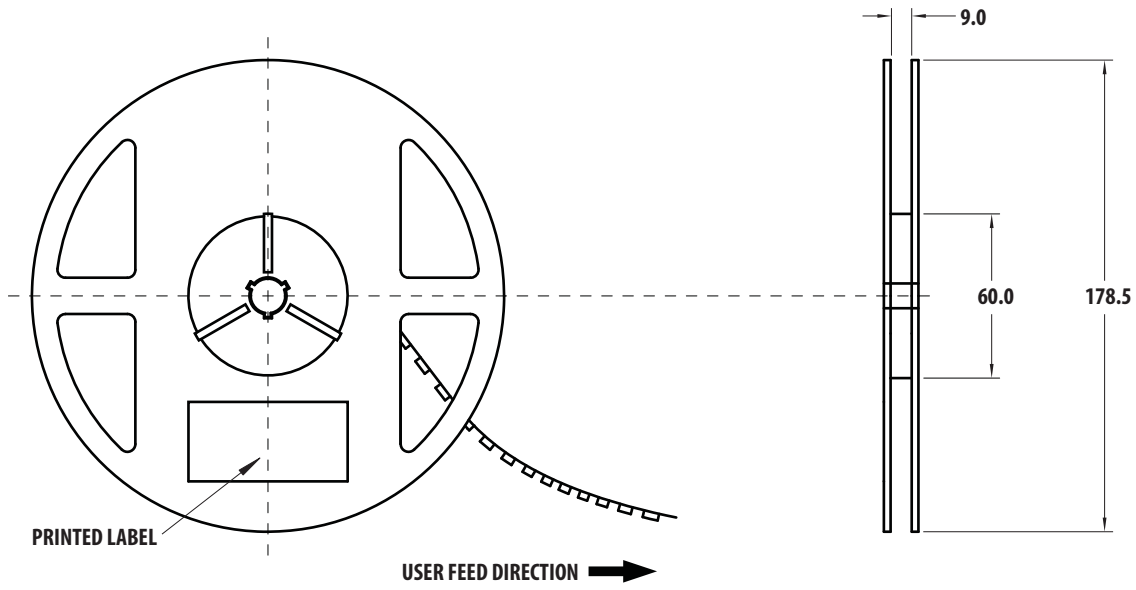
**NOTE** All dimensions are in millimeters.

**Figure 22: Carrier Tape Dimensions**



**NOTE** All dimensions are in millimeters.

Figure 23: Reel Dimensions



**NOTE** All dimensions are in millimeters.

## Precautionary Notes

### Soldering

- Do not perform reflow soldering more than twice. Observe necessary precautions of handling moisture-sensitive device as stated in the following section.
- Do not apply any pressure or force on the LED during reflow and after reflow when the LED is still hot.
- Use reflow soldering to solder the LED. Use hand soldering only for rework if unavoidable, but it must be strictly controlled to following conditions:
  - Soldering iron tip temperature = 315°C max.
  - Soldering duration = 3 sec max.
  - Number of cycles = 1 only.
  - Power of soldering iron = 50W max.
- Do not touch the LED package body with the soldering iron except for the soldering terminals, as it may cause damage to the LED.
- Confirm beforehand whether the functionality and performance of the LED is affected by soldering with hand soldering.

Figure 24: Recommended Lead-Free Reflow Soldering Profile

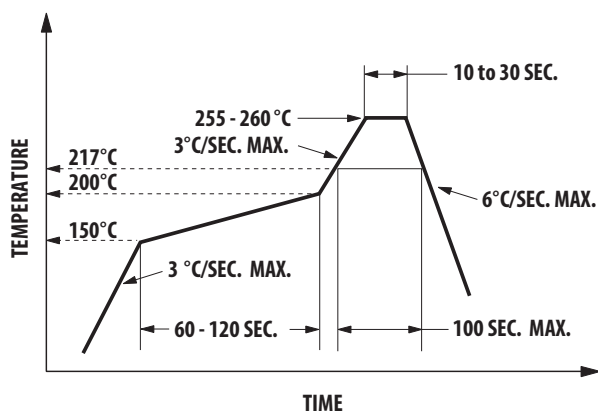
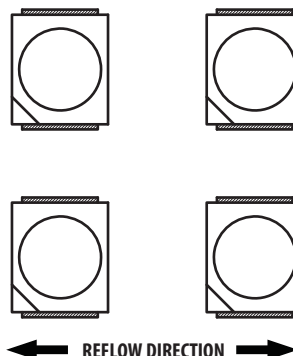


Figure 25: Recommended Board Reflow Direction



### Handling Precautions

The encapsulation material of the LED is made of silicone for better product reliability. Compared to epoxy encapsulant, which is hard and brittle, silicone is softer and flexible. Observe special handling precautions during assembly of silicone encapsulated LED products. Failure to comply might lead to damage and premature failure of the LED. Refer to Broadcom Application Note AN5288, *Silicone Encapsulation for LED: Advantages and Handling Precautions*, for additional information.

- Do not poke sharp objects into the silicone encapsulant. Sharp objects, such as tweezers or syringes, might apply excessive force or even pierce through the silicone and induce failures to the LED die or wire bond.
- Do not touch the silicone encapsulant. Uncontrolled force acting on the silicone encapsulant might result in excessive stress on the wire bond. Hold the LED only by the body.
- Do not stack assembled PCBs together. Use an appropriate rack to hold the PCBs.
- Surface of silicone material attracts dust and dirt easier than epoxy due to its surface tackiness. To remove foreign particles on the surface of silicone, use a cotton bud with isopropyl alcohol (IPA). During cleaning, rub the surface gently without putting too much pressure on the silicone. Ultrasonic cleaning is not recommended.
- For automated pick and place, Broadcom has tested a nozzle size with OD 1.5 mm to work with this LED. However, due to the possibility of variations in other parameters such as pick and place machine maker/model, and other settings of the machine, verify that the selected nozzle will not cause damage to the LED.

## Handling of Moisture-Sensitive Device

This product has a Moisture Sensitive Level 3 rating per JEDEC J-STD-020. Refer to Broadcom Application Note AN5305, *Handling of Moisture Sensitive Surface Mount Devices*, for additional details and a review of proper handling procedures.

- Before use:
  - An unopened moisture barrier bag (MBB) can be stored at <40°C/90% RH for 12 months. If the actual shelf life has exceeded 12 months and the Humidity Indicator Card (HIC) indicates that baking is not required, then it is safe to reflow the LEDs per the original MSL rating.
  - Do not open the MBB prior to assembly (for example, for IQC). If unavoidable, MBB must be properly resealed with fresh desiccant and HIC. The exposed duration must be taken in as floor life.
- Control after opening the MBB:
  - Read the HIC immediately upon opening of MBB.
  - Keep the LEDs at <30°/60% RH at all times, and complete all high temperature-related processes, including soldering, curing or rework within 168 hours.
- Control for unfinished reel:
 

Store unused LEDs in a sealed MBB with desiccant or a desiccator at <5% RH.
- Control of assembled boards:
 

If the PCB soldered with the LEDs is to be subjected to other high-temperature processes, store the PCB in a sealed MBB with desiccant or desiccator at <5% RH to ensure that all LEDs have not exceeded their floor life of 168 hours.
- Baking is required if:
  - The HIC indicator indicates a change in color for 10% and 5%, as stated on the HIC.
  - The LEDs are exposed to conditions of >30°C/60% RH at any time.
  - The LED's floor life exceeded 168 hours.

The recommended baking condition is: 60°C ± 5°C for 20 hours.

Baking can only be done once.

### Storage:

The soldering terminals of these Broadcom LEDs are silver plated. If the LEDs are exposed in ambient environment for too long, the silver plating might be

oxidized, thus affecting its solderability performance. As such, keep unused LEDs in a sealed MBB with desiccant or in a desiccator at <5% RH.

## Application Precautions

- The drive current of the LED must not exceed the maximum allowable limit across temperature as stated in the data sheet. Constant current driving is recommended to ensure consistent performance.
- Circuit design must cater to the whole range of forward voltage ( $V_F$ ) of the LEDs to ensure the intended drive current can always be achieved.
- The LED exhibits slightly different characteristics at different drive currents, which can result in a larger variation of performance (meaning: intensity, wavelength, and forward voltage). Set the application current as close as possible to the test current to minimize these variations.
- The LED is not intended for reverse bias. Use other appropriate components for such purposes. When driving the LED in matrix form, ensure that the reverse bias voltage does not exceed the allowable limit of the LED.
- Do not use the LED in the vicinity of material with sulfur content or in environments of high gaseous sulfur compounds and corrosive elements. Examples of material that might contain sulfur are rubber gaskets, room- temperature vulcanizing (RTV) silicone rubber, rubber gloves, and so on. Prolonged exposure to such environments can affect the optical characteristics and product life.
- Because actual application might not be exactly similar to the test conditions, verify that the LED will not be damaged by prolonged exposure in the intended environment.
- Avoid rapid change in ambient temperature, especially in high-humidity environments, because they cause condensation on the LED.
- If the LED is intended to be used in harsh or outdoor environment, protect the LED against damages caused by rain water, water, dust, oil, corrosive gases, external mechanical stresses, and so on.

## Thermal Management

Optical, electrical, and reliability characteristics of the LED are affected by temperature. Keep the junction temperature ( $T_J$ ) of the LED below the allowable limit at all times.  $T_J$  can be calculated as follows:

$$T_J = T_A + R_{\theta J-A} \times I_F \times V_{Fmax}$$

where:

$T_A$  = ambient temperature ( $^{\circ}\text{C}$ ).

$R_{\theta_{J-A}}$  = thermal resistance from LED junction to ambient ( $^{\circ}\text{C}/\text{W}$ ).

$I_F$  = forward current (A).

$V_{Fmax}$  = maximum forward voltage (V).

The complication of using this formula lies in  $T_A$  and  $R_{\theta_{J-A}}$ . Actual  $T_A$  is sometimes subjective and hard to determine.  $R_{\theta_{J-A}}$  varies from system to system depending on design and is usually not known.

Another way of calculating  $T_J$  is by using the solder point temperature,  $T_S$  as follows:

$$T_J = T_S + R_{\theta_{J-S}} \times I_F \times V_{Fmax}$$

where:

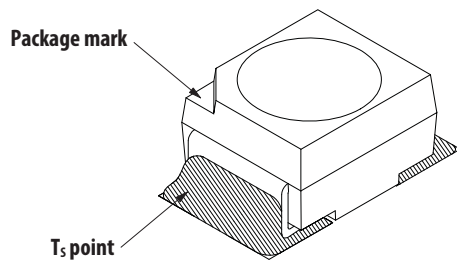
$T_S$  = LED solder point temperature as shown in [Figure 26](#) ( $^{\circ}\text{C}$ ).

$R_{\theta_{J-S}}$  = thermal resistance from junction to solder point ( $^{\circ}\text{C}/\text{W}$ ).

$I_F$  = forward current (A).

$V_{Fmax}$  = maximum forward voltage (V).

**Figure 26: Solder Point Temperature on PCB**



$T_S$  can be easily measured by mounting a thermocouple on the soldering joint as shown in [Figure 26](#), while  $R_{\theta_{J-S}}$  is provided in this data sheet. Verify the  $T_S$  of the LED in the final product to ensure that the LEDs are operating within all maximum ratings stated in this data sheet.

## Eye Safety Precautions

LEDs may pose optical hazards when in operation. Do not look directly at operating LEDs because it might be harmful to the eyes. For safety reasons, use appropriate shielding or personal protective equipment.



## Disclaimer

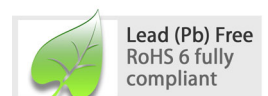
Broadcom's products and software are not specifically designed, manufactured, or authorized for sale as parts, components, or assemblies for the planning, construction, maintenance, or direct operation of a nuclear facility or for use in medical devices or applications. The customer is solely responsible, and waives all rights to make claims against Broadcom or its suppliers, for all loss, damage, expense, or liability in connection with such use.

Broadcom, the pulse logo, Connecting everything, Avago Technologies, Avago, and the A logo are among the trademarks of Broadcom and/or its affiliates in the United States, certain other countries, and/or the EU.

Copyright © 2017–2021 Broadcom. All Rights Reserved.

The term “Broadcom” refers to Broadcom Inc. and/or its subsidiaries. For more information, please visit [www.broadcom.com](http://www.broadcom.com).

Broadcom reserves the right to make changes without further notice to any products or data herein to improve reliability, function, or design. Information furnished by Broadcom is believed to be accurate and reliable. However, Broadcom does not assume any liability arising out of the application or use of this information, nor the application or use of any product or circuit described herein, neither does it convey any license under its patent rights nor the rights of others.



## X-ON Electronics

Largest Supplier of Electrical and Electronic Components

*Click to view similar products for [Standard LEDs - SMD category](#):*

*Click to view products by [Broadcom manufacturer](#):*

Other Similar products are found below :

[LTST-C19GD2WT](#) [LTST-N683GBEW](#) [LTW-170ZDC](#) [LTW-M140SZS40](#) [598-8110-100F](#) [598-8170-100F](#) [598-8610-202F](#) [67-22VRVGC/TR8](#) [AAAF5060QBFSEEZGS](#) [HLMP-6305-L0011](#) [ALMD-LB36-SV002](#) [APT1608QGW](#) [15-21UYC/S530-A3/TR8](#) [EASV1803BA0](#) [LG M67K-H1J2-24-0-2-R18-Z](#) [LS A676-P2S1-1](#) [SML310BATT86](#) [SML-512VWT86A](#) [SML-LX0606SISUGC/A](#) [SML-LXL1307SRC-TR](#) [SML-LXR851SIUPGUBC](#) [LT1ED53A](#) [FAT801-S](#) [AM27ZGC03](#) [APB3025SGNC](#) [APFA3010SURKCGKQBDC](#) [APHK1608VGCA](#) [APT2012QGW](#) [CLX6D-FKB-CN1R1H1BB7D3D3](#) [LTST-C250KGKT](#) [LTW-020ZDCG](#) [LTW-21TS5](#) [LTW-220DS5](#) [JANTXM19500/521-02](#) [UYGT801-S](#) [42-21UYC/S530-A3/TR8](#) [LO T67F-V1AB-24-1](#) [YGFR411-H](#) [SML-LX0402IC-TR](#) [CMDA20AYAA7D1S](#) [CMDA16AYDR7A1X](#) [339-1SURSYGW/S530-A2](#) [598-8040-100F](#) [598-8070-100F](#) [598-8140-100F](#) [598-8610-200F](#) [EAPL3527GA5](#) [67-11/BHC-M1N2B8Y/2A0](#) [SML-LXL1209SYC/ATR](#) [EASV3020YGA0](#)