

### Data Sheet



---

#### Description

The ASMT-Ax00 series of 1W Power LEDs are high performance energy efficient devices which can handle high driving current and high temperatures. The exposed pad design enables excellent heat transfer from the package to the motherboard. An electrically isolated metal slug option is also available.

The White Power LED is available with color temperatures ranging from 2700K to 10000K.

The low profile package design is suitable for a wide variety of applications especially where height is a constraint and the package foot print is compatible with most high power LEDs available in the market today.

This package is compatible with reflow soldering process.

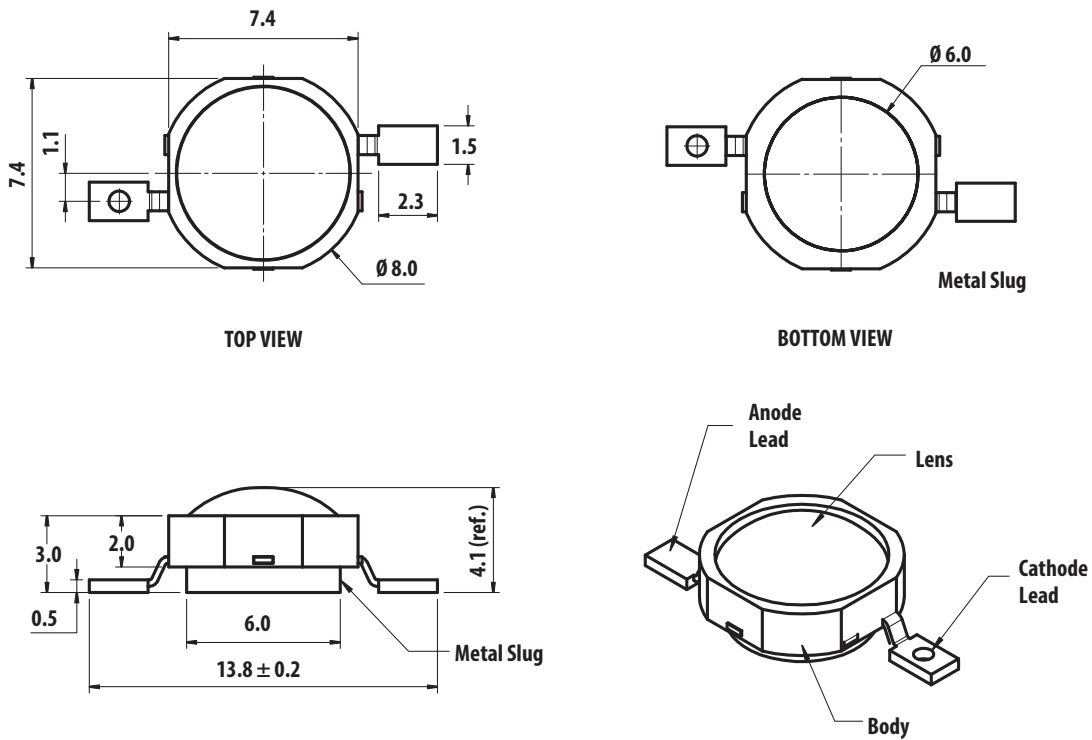
#### Features

- Available in red, amber, blue, royal blue, cyan, green, cool white, neutral white, and warm white colors
- Energy efficient
- Exposed metal slug for excellent heat transfer
- Compatible with reflow soldering process
- High current operation
- Long operation life
- Wide viewing angle at 140°
- Silicone encapsulation
- Non-ESD sensitive (threshold > 16 kV)
- MSL 2a products

#### Applications

- Architectural lighting
- Channel backlighting
- Contour lighting
- Retail display lighting
- Decorative lighting
- Garden lighting

Figure 1 ASMT-Ax00 Package Outline Drawing

**NOTE**

1. All dimensions in millimeters.
2. Metal slug is connected to anode for electrically non-isolated option.
3. Tolerance is  $\pm 0.1$  mm unless otherwise specified.
4. Terminal finish: Ag plating.

## Device Selection Guide ( $T_J = 25^\circ\text{C}$ )

Part Number	Color	Luminous Flux (lm) / Radiometric Power (mW), $\Phi_V$ <sup>a, b</sup>			Test Current (mA)	Dice Technology	Electrically Isolated Metal Slug
		Min.	Typ.	Max.			
ASMT-AR00-ARS00	Red	39.8	50.0	67.2	350	AllInGaP	No <sup>c</sup>
ASMT-AR00-AST00		51.7	65.0	87.4			
ASMT-AA00-ARS00	Amber	39.8	50.0	67.2	350	AllInGaP	No <sup>c</sup>
ASMT-AB00-NMP00	Blue	13.9	20.0	30.6	350	InGaN	Yes
ASMT-AL00-NNQ00	Royal Blue	275 mW	355 mW	515 mW	350	InGaN	Yes
ASMT-AL00-NQS00		435 mW	550 mW	685 mW			
ASMT-AC00-NSU00	Cyan	51.7	75.0	99.6	350	InGaN	Yes
ASMT-AG00-NUV00	Green	87.4	105.0	113.6	350	InGaN	Yes
ASMT-AW00-NUW00	Cool White	87.4	100.0	129.5	350	InGaN	Yes
ASMT-AN00-NUW00	Neutral White	87.4	100.0	129.5	350	InGaN	Yes
ASMT-AY00-NUV00	Warm White	87.4	95.0	113.6	350	InGaN	Yes

- a.  $\Phi_V$  is the total luminous flux/radiometric power output as measured with an integrating sphere at 25-ms mono pulse condition.  
b. Flux tolerance is  $\pm 10\%$ .  
c. Electrically isolated metal slug option is also available. Contact your Broadcom sales representative.

## Absolute Maximum Ratings

Parameter	AllInGaP	InGaN	InGaN Cyan	Units
DC Forward Current <sup>a</sup>	500	500	500	mA
Peak Pulsing Current <sup>b</sup>	1000	1000	1000	mA
Power Dissipation	1230	1830	1980	mW
LED Junction Temperature	125	135	135	$^\circ\text{C}$
Operating Metal Slug Temperature Range at 350 mA	-40 to +115	-40 to +120	-40 to +120	$^\circ\text{C}$
Storage Temperature Range	-40 to +120	-40 to +120	-40 to +120	$^\circ\text{C}$
Soldering Temperature	See <a href="#">Figure 29</a>			
Reverse Voltage <sup>c</sup>	Not recommended			

- a. Derate linearly based on [Figure 13](#) and [Figure 14](#) for AllInGaP and [Figure 25](#) and [Figure 26](#) for InGaN.  
b. Pulse condition duty factor = 10%, Frequency = 1 kHz.  
c. Not recommended for reverse bias operation.

## Optical Characteristics at 350 mA ( $T_J = 25^\circ\text{C}$ )

Part Number	Color	Peak Wavelength, $\lambda_{\text{PEAK}}$ (nm)	Dominant Wavelength, $\lambda_D$ (nm) <sup>a</sup>	Viewing Angle, $2\theta_{1/2}$ (°) <sup>b</sup>	Luminous Efficiency (lm/W)
		Typ.	Typ.	Typ.	Typ.
ASMT-AR00-ARS00	Red	635	625	140	68
ASMT-AR00-AST00		635	625	140	88
ASMT-AA00-ARS00	Amber	598	590	140	68
ASMT-AG00-NUV00	Green	519	525	140	94
ASMT-AC00-NSU00	Cyan	497	500	140	63
ASMT-AB00-NMP00	Blue	454	460	140	18
ASMT-AL00-NNQ00	Royal Blue	450	455	140	Not applicable
ASMT-AL00-NQS00		450	455	140	Not applicable

a. The dominant wavelength,  $\lambda_D$ , is derived from the CIE Chromaticity Diagram and represents the color of the device.

b.  $\theta_{1/2}$  is the off-axis angle where the luminous intensity is half of the peak intensity.

Part Number	Color	Correlated Color Temperature, CCT (Kelvin)		Viewing Angle, $2\theta_{1/2}$ (°) <sup>a</sup>	Luminous Efficiency (lm/W)
		Min.	Max.	Typ.	Typ.
ASMT-AW00-NUW00	Cool White	4500	10000	140	89
ASMT-AN00-NUW00	Neutral White	3500	4500	140	89
ASMT-AY00-NUV00	Warm White	2700	3500	140	85

a.  $\theta_{1/2}$  is the off-axis angle where the luminous intensity is half of the peak intensity.

## Electrical Characteristic at 350 mA ( $T_J = 25^\circ\text{C}$ )

Dice Type	Forward Voltage, $V_F$ (Volts)			Thermal Resistance, $R_{\theta j-ms}$ (°C/W) <sup>a</sup>
	Min.	Typ.	Max.	Typ.
AllnGaP	1.7	2.1	2.3	10
InGaN (non-Cyan Colors)	2.8	3.2	3.5	10
InGaN Cyan	2.6	3.0	3.8	10

a.  $R_{\theta j-ms}$  is thermal resistance from LED junction to metal slug.

## Part Numbering System

A S M T - A x<sub>1</sub> 0 0 - x<sub>2</sub> x<sub>3</sub> x<sub>4</sub> x<sub>5</sub> x<sub>6</sub>

Code	Description	Option	
x <sub>1</sub>	Color	R	Red
		A	Amber
		G	Green
		C	Cyan
		B	Blue
		L	Royal Blue
		W	Cool White
		N	Neutral White
		Y	Warm White
x <sub>2</sub>	Dice Type	N	InGaN
		A	AllnGaP
x <sub>3</sub>	Minimum Flux Bin	See Flux/Power Bin Limit Table	
x <sub>4</sub>	Maximum Flux Bin		
x <sub>5</sub>	Color Bin Selection	See Color Bin Selection Table	
x <sub>6</sub>	Packaging Option	0	Tube
		1	Tape and Reel

## Bin Information

### Flux/Power Bin Limit ( $x_3$ , $x_4$ )

Color	Bin ID	Luminous Flux (lm)/Radiometric Power (mW) at 350 mA	
		Min.	Max.
Blue	K	8.2	10.7
	L	10.7	13.9
	M	13.9	18.1
	N	18.1	23.5
	P	23.5	30.6
Other Colors	Q	30.6	39.8
	R	39.8	51.7
	S	51.7	67.2
	T	67.2	87.4
	U	87.4	99.6
	V	99.6	113.6
	W	113.6	129.5
Royal Blue	M	225.0	275.0
	N	275.0	355.0
	P	355.0	435.0
	Q	435.0	515.0
	R	515.0	595.0
	S	595.0	685.0

Tolerance for each bin limit is  $\pm 10\%$ .

## Color Bin Selection (x<sub>5</sub>)

Individual reel will contain parts from one full bin only.

### Cool White

Selection	Bin ID
0	Full Distribution
E	VM, UM, VN, and UN
F	WM, VM, WN, and VN
G	XM, WM, XN, and WN
H	UN, VN, U0, and V0
J	WN, VN, W0, and V0
K	XN, WN, X0, and W0
L	V0, U0, VP, and UP
M	W0, V0, WP, VP, and WQ
N	X0, W0, XP, WP, and WQ
P	Y0
Q	YA

### Warm White

Selection	Bin ID
0	Full Distribution
E	NM, MM, N1, and M1
F	PM, NM, P1, and N1
G	QM, PM, Q1, and P1
H	M1, N1, M0, and N0
J	P1, N1, P0, and N0
K	Q1, P1, Q0, and P0
L	N0, M0, NA, and MA
M	P0, N0, PA, and NA
N	Q0, P0, QA, and PA

### Neutral White

Selection	Bin ID
0	Full Distribution
E	SM, RM, S1, and R1
F	TM, SM, TN, and S1
G	S1, R1, S0, and R0
H	TN, S1, T0, and S0
J	S0, R0, SA, and RA
K	T0, S0, TP, and SA

### Other Colors

Selection	Bin ID
0	Full Distribution
Z	A and B
Y	B and C
W	C and D
V	D and E
U	E and F
Q	A, B, and C
P	B, C, and D
N	C, D, and E
M	D, E, and F

Figure 2 Color Bin Structure for Cool White

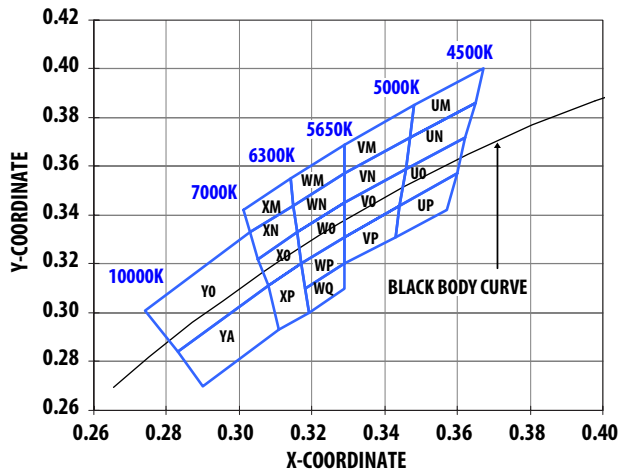


Figure 3 Color Bin Structure for Warm White

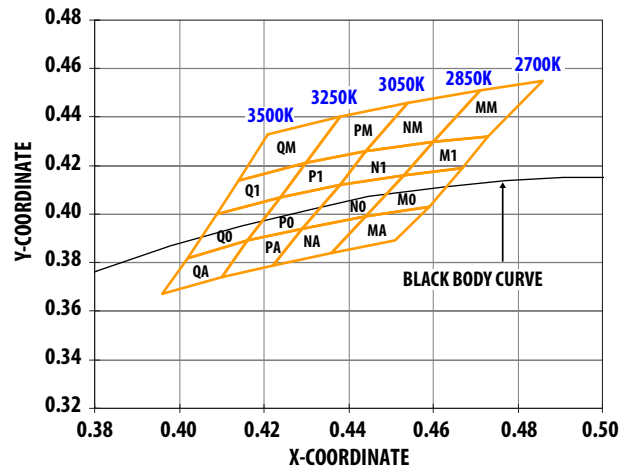
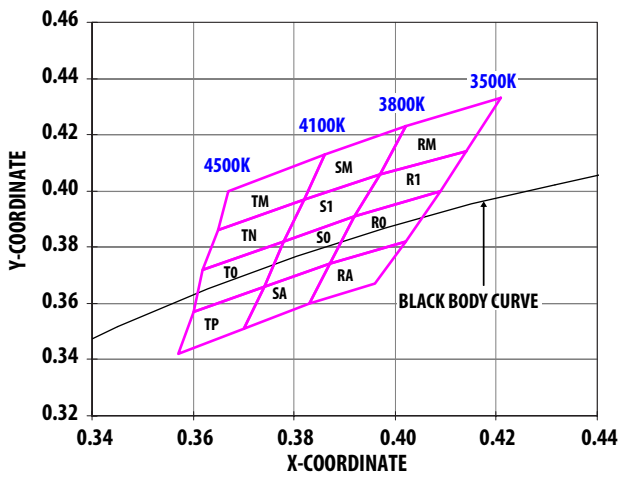


Figure 4 Color Bin Structure for Neutral White





## Color Bin Limits

Cool White	Color Limits (Chromaticity Coordinates)				
Bin UM	x	0.365	0.367	0.348	0.347
	y	0.385	0.400	0.385	0.372
Bin UN	x	0.365	0.362	0.346	0.347
	y	0.386	0.372	0.359	0.372
Bin UO	x	0.362	0.360	0.344	0.346
	y	0.372	0.357	0.344	0.359
Bin UP	x	0.360	0.357	0.343	0.344
	y	0.357	0.342	0.311	0.344
Bin VM	x	0.329	0.329	0.348	0.347
	y	0.357	0.369	0.385	0.372
Bin VN	x	0.329	0.329	0.347	0.346
	y	0.345	0.357	0.372	0.359
Bin VO	x	0.329	0.329	0.346	0.344
	y	0.331	0.345	0.359	0.344
Bin VP	x	0.329	0.344	0.343	0.329
	y	0.331	0.344	0.331	0.320
Bin WM	x	0.329	0.329	0.315	0.314
	y	0.369	0.357	0.344	0.355
Bin WN	x	0.329	0.316	0.315	0.329
	y	0.345	0.333	0.344	0.357
Bin WO	x	0.329	0.329	0.317	0.316
	y	0.345	0.331	0.320	0.333
Bin WP	x	0.329	0.329	0.318	0.317
	y	0.331	0.320	0.310	0.320
Bin WQ	x	0.329	0.329	0.319	0.318
	y	0.320	0.310	0.300	0.310
Bin XM	x	0.301	0.314	0.315	0.303
	y	0.342	0.355	0.344	0.333
Bin XN	x	0.305	0.303	0.315	0.316
	y	0.322	0.333	0.344	0.333
Bin XO	x	0.308	0.305	0.316	0.317
	y	0.311	0.322	0.333	0.320
Bin XP	x	0.308	0.317	0.319	0.311
	y	0.311	0.320	0.300	0.293
Bin YO	x	0.308	0.283	0.274	0.303
	y	0.311	0.284	0.301	0.333
Bin YA	x	0.308	0.311	0.290	0.283
	y	0.311	0.293	0.270	0.284

Tolerance:  $\pm 0.01$ 

Warm White	Color Limits (Chromaticity Coordinates)				
Bin MM	x	0.471	0.460	0.473	0.486
	y	0.451	0.430	0.432	0.455
Bin M1	x	0.460	0.453	0.467	0.473
	y	0.430	0.416	0.419	0.432
Bin M0	x	0.453	0.444	0.459	0.467
	y	0.416	0.399	0.403	0.419
Bin MA	x	0.459	0.444	0.436	0.451
	y	0.403	0.399	0.384	0.389
Bin NM	x	0.454	0.444	0.460	0.471
	y	0.446	0.426	0.430	0.451
Bin N1	x	0.444	0.438	0.453	0.460
	y	0.426	0.412	0.416	0.430
Bin N0	x	0.438	0.429	0.444	0.453
	y	0.412	0.394	0.399	0.416
Bin NA	x	0.444	0.429	0.422	0.436
	y	0.399	0.394	0.379	0.384
Bin PM	x	0.438	0.430	0.444	0.454
	y	0.440	0.421	0.426	0.446
Bin P1	x	0.430	0.424	0.438	0.444
	y	0.421	0.407	0.412	0.426
Bin P0	x	0.424	0.416	0.429	0.438
	y	0.407	0.389	0.394	0.412
Bin PA	x	0.429	0.416	0.410	0.422
	y	0.394	0.389	0.374	0.379
Bin QM	x	0.421	0.414	0.430	0.438
	y	0.433	0.414	0.421	0.440
Bin Q1	x	0.414	0.409	0.424	0.430
	y	0.414	0.400	0.407	0.421
Bin Q0	x	0.409	0.402	0.416	0.424
	y	0.400	0.382	0.389	0.407
Bin QA	x	0.416	0.402	0.396	0.410
	y	0.389	0.382	0.367	0.374

Tolerance:  $\pm 0.01$

Neutral White	Color Limits (Chromaticity Coordinates)				
Bin RM	x	0.421	0.414	0.397	0.402
	y	0.433	0.414	0.406	0.423
Bin R1	x	0.414	0.409	0.392	0.397
	y	0.414	0.400	0.391	0.406
Bin R0	x	0.392	0.387	0.402	0.409
	y	0.391	0.374	0.382	0.400
Bin RA	x	0.387	0.383	0.396	0.402
	y	0.374	0.360	0.367	0.382
Bin SM	x	0.402	0.397	0.382	0.386
	y	0.423	0.406	0.397	0.413
Bin S1	x	0.397	0.392	0.378	0.382
	y	0.406	0.391	0.382	0.397
Bin S0	x	0.392	0.387	0.374	0.378
	y	0.391	0.374	0.366	0.382
Bin SA	x	0.387	0.383	0.370	0.374
	y	0.374	0.360	0.351	0.366
Bin TM	x	0.386	0.382	0.365	0.367
	y	0.413	0.397	0.386	0.400
Bin TN	x	0.382	0.378	0.362	0.365
	y	0.397	0.382	0.372	0.386
Bin T0	x	0.378	0.374	0.360	0.362
	y	0.382	0.366	0.357	0.372
Bin TP	x	0.374	0.370	0.357	0.360
	y	0.366	0.351	0.342	0.357

Tolerance:  $\pm 0.01$ 

Color	Bin ID	Dominant Wavelength (nm) at 350 mA	
		Min.	Max.
Red	—	620.0	635.0
Amber	B	587.0	589.5
	C	589.5	592.0
	D	592.0	594.5
	E	594.5	597.0
Blue	A	455.0	460.0
	B	460.0	465.0
	C	465.0	470.0
	D	470.0	475.0
Cyan	C	490.0	495.0
	D	495.0	500.0
	E	500.0	505.0
	F	505.0	510.0
	G	510.0	515.0
	H	515.0	520.0
Green	A	515.0	520.0
	B	520.0	525.0
	C	525.0	530.0
	D	530.0	535.0

Tolerance:  $\pm 1$  nm

Color	Bin ID	Peak Wavelength (nm) at 350 mA	
		Min.	Max.
Royal Blue	C	440.0	445.0
	D	445.0	450.0
	E	450.0	455.0
	F	455.0	460.0

Tolerance:  $\pm 2$  nm

---

## Example

### ASMT-AW00-NUW00

- ASMT-AW00-Nxxxx – Cool White, InGaN, Electrically isolated  
Heat Sink
- $X_3 = U$  – Minimum Flux Bin U
- $X_4 = W$  – Maximum Flux Bin W
- $X_5 = 0$  – Full Distribution
- $X_6 = 0$  – Tube Option

# AlInGaP

Figure 5 Relative Intensity vs. Wavelength for Red and Amber

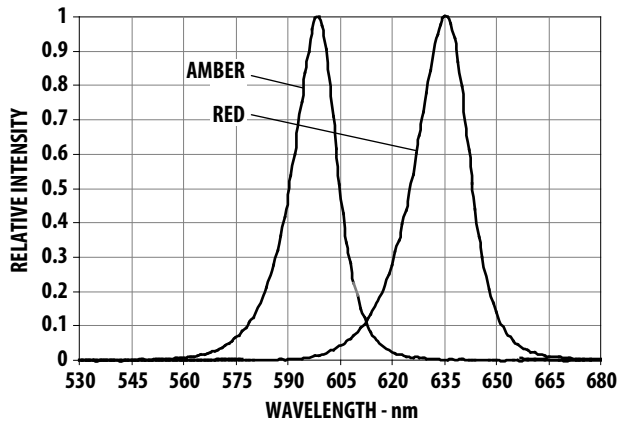


Figure 6 Relative Luminous Flux vs. Mono Pulse Current

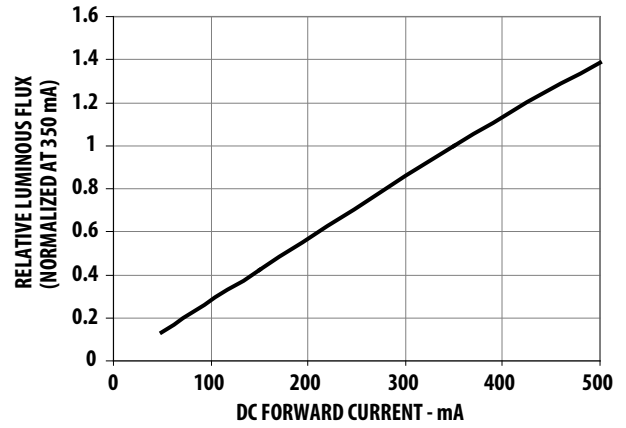


Figure 7 Forward Current vs. Forward Voltage

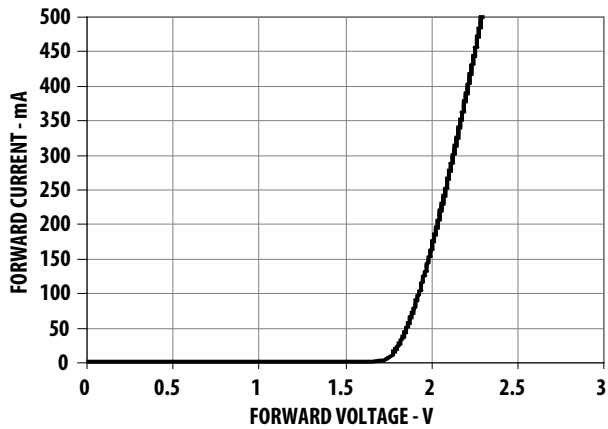


Figure 8 Radiation Pattern for Red and Amber

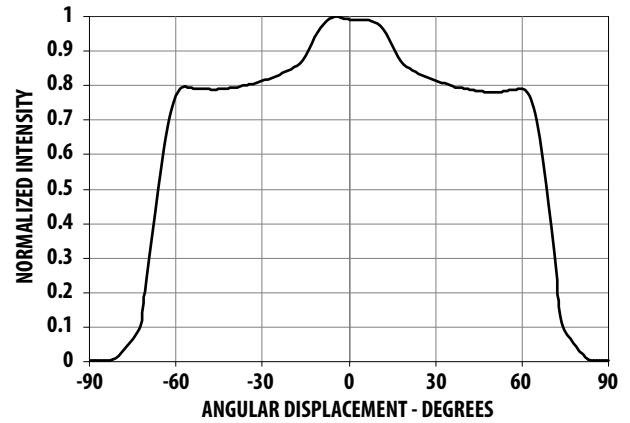


Figure 9 Maximum Pulse Current vs. Pulse Duration. Derated based on  $T_A = 25^\circ\text{C}$ ,  $R_{\theta J-A} = 50^\circ\text{C/W}$ .

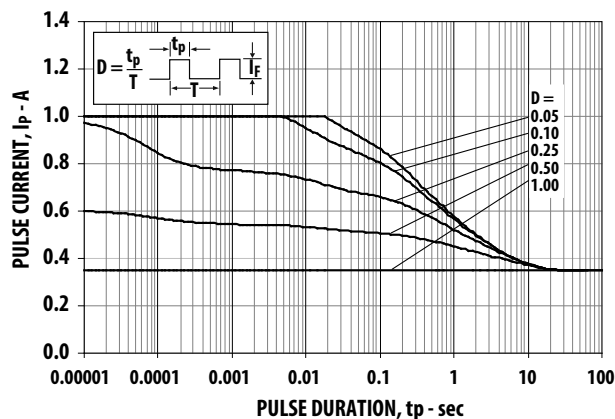
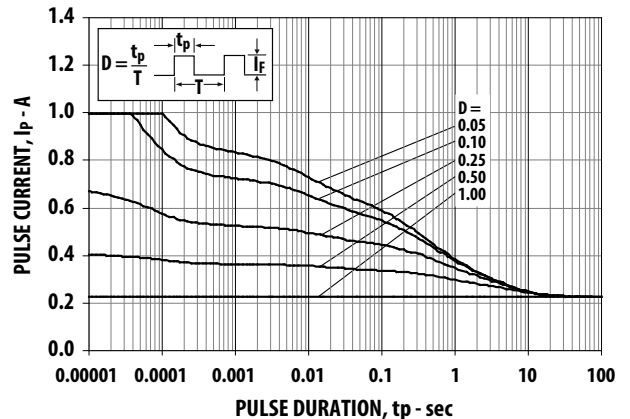


Figure 10 Maximum Pulse Current vs. Pulse Duration. Derated based on  $T_A = 85^\circ\text{C}$ ,  $R_{\theta J-A} = 50^\circ\text{C/W}$ .



# AllnGaP

Figure 11 Relative Light Output vs. Junction Temperature

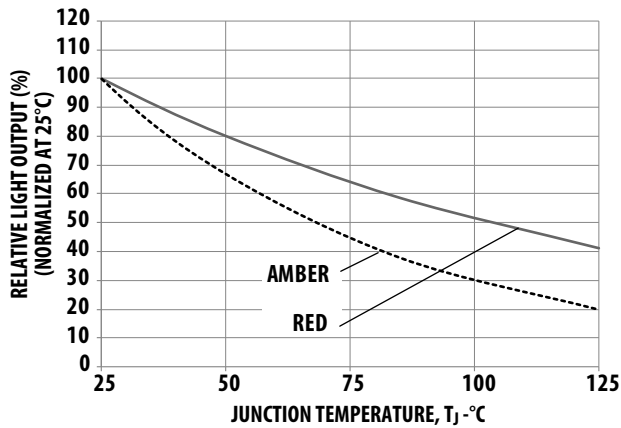


Figure 12 Forward Voltage Shift vs. Junction Temperature

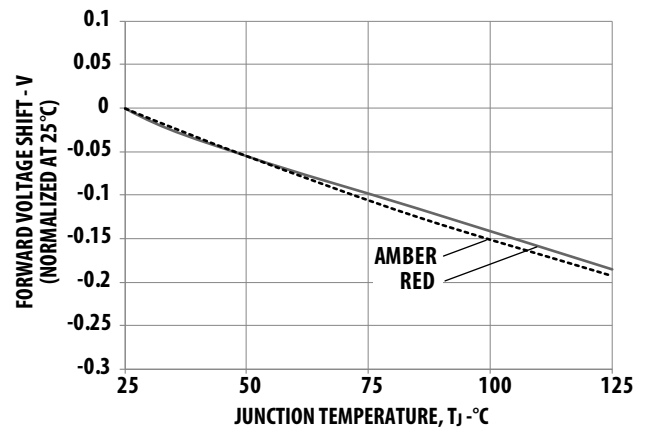


Figure 13 Maximum Forward Current vs. Ambient Temperature. Derated based on  $T_{JMAX} = 125^\circ\text{C}$ ,  $R_{\theta J-A} = 30^\circ\text{C/W}$ ,  $40^\circ\text{C/W}$ , and  $50^\circ\text{C/W}$ .

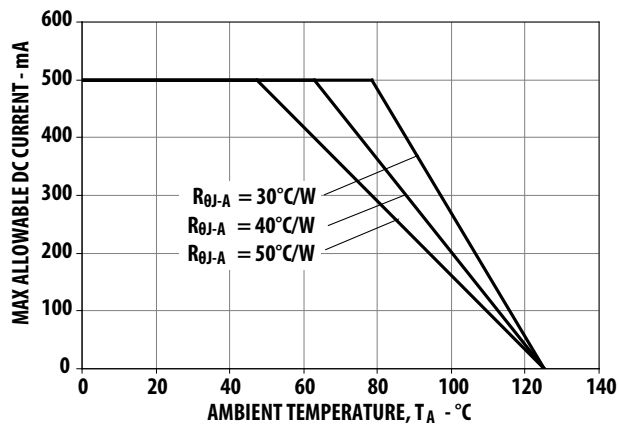
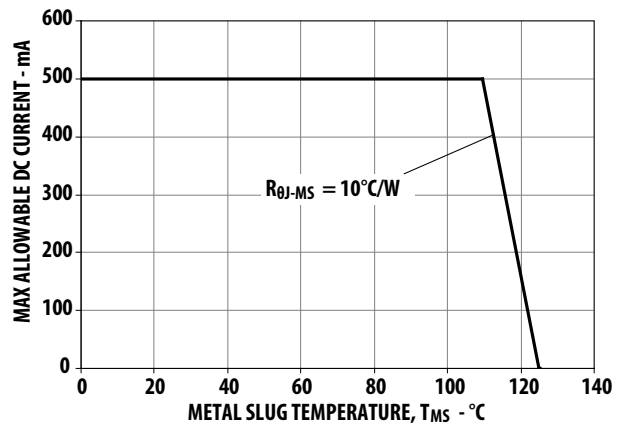
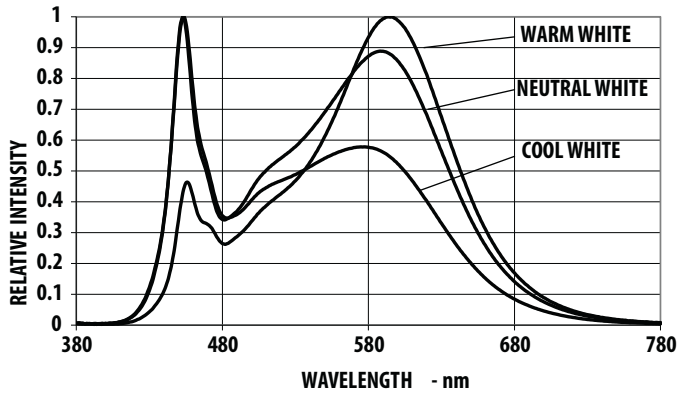


Figure 14 Maximum Forward Current vs. Metal Slug Temperature. Derated based on  $T_{JMAX} = 125^\circ\text{C}$ ,  $R_{\theta J-MS} = 10^\circ\text{C/W}$ .

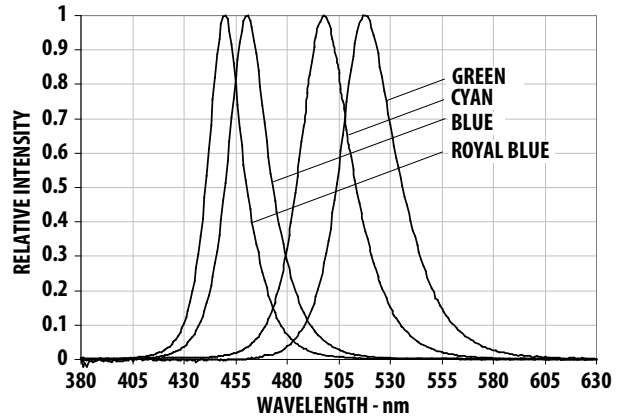


# InGaN

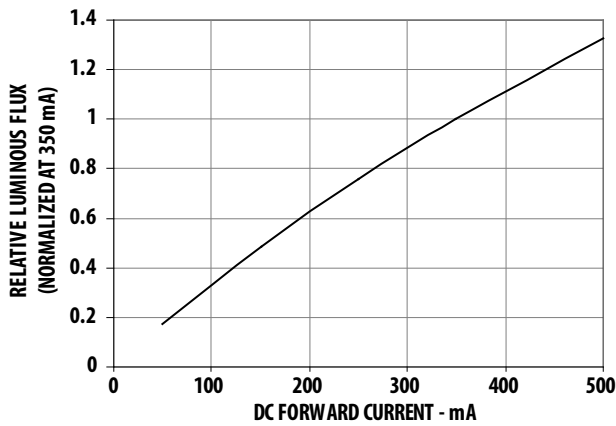
**Figure 15 Relative Intensity vs. Wavelength for Cool, Neutral, and Warm White**



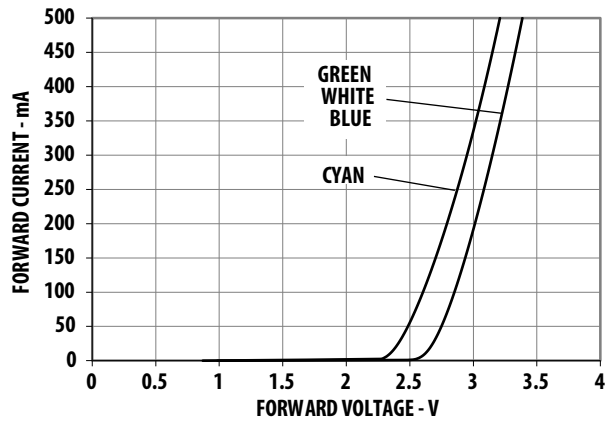
**Figure 16 Relative Intensity vs. Wavelength for Blue, Royal Blue, Cyan, and Green**



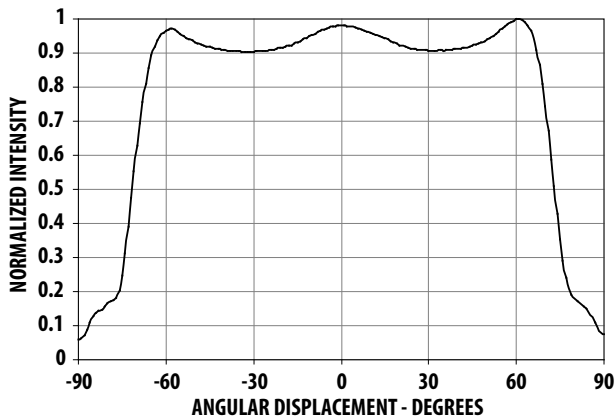
**Figure 17 Relative Luminous Flux vs. Mono Pulse Current**



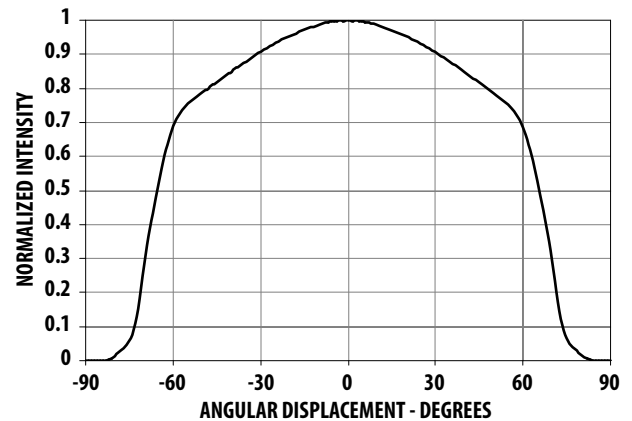
**Figure 18 Forward Current vs. Forward Voltage**



**Figure 19 Radiation Pattern for Blue, Royal Blue, Cyan, and Green**

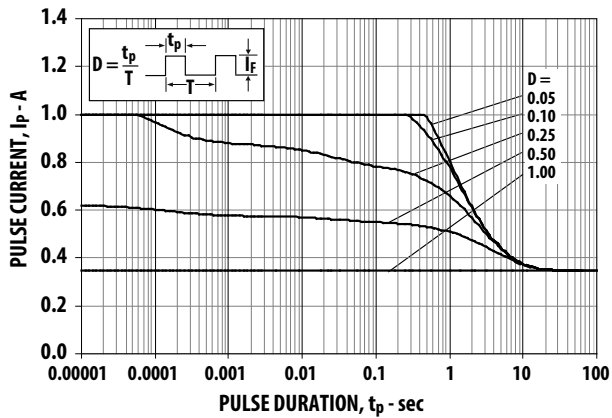


**Figure 20 Radiation Pattern for Cool White, Neutral White, and Warm White**

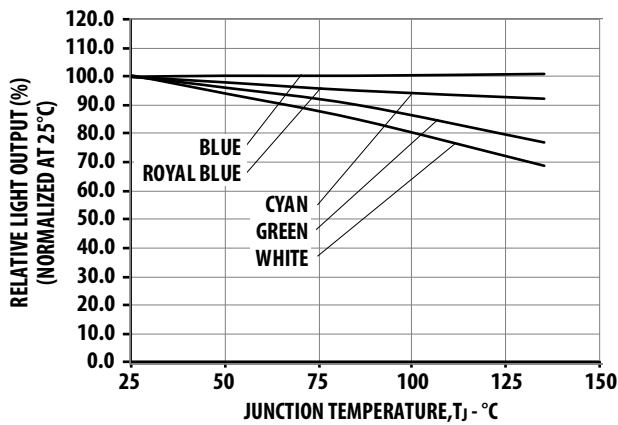


# InGaN

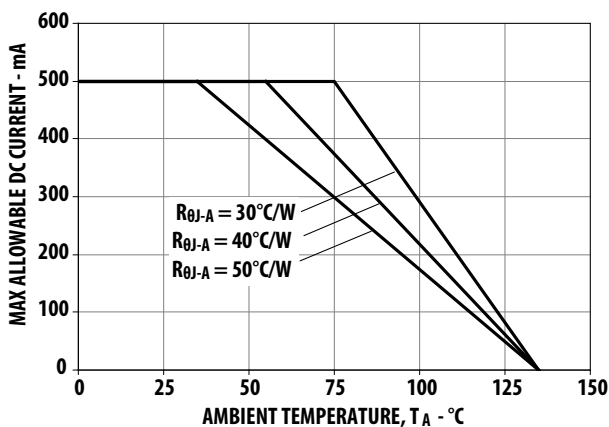
**Figure 21 Maximum Pulse Current vs. Pulse Duration. Derated based on  $T_A = 25^\circ\text{C}$ ,  $R_{\theta J-A} = 50^\circ\text{C/W}$ .**



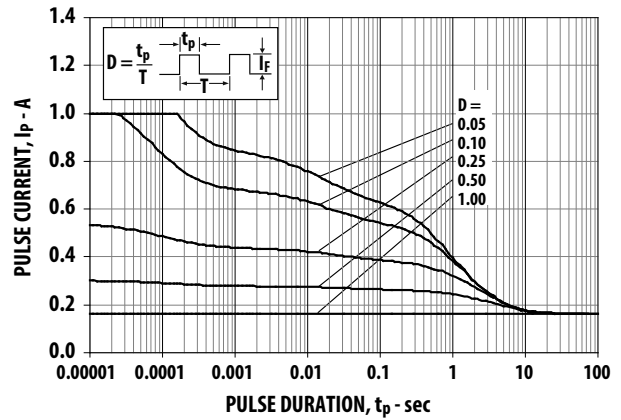
**Figure 23 Relative Light Output vs. Junction Temperature**



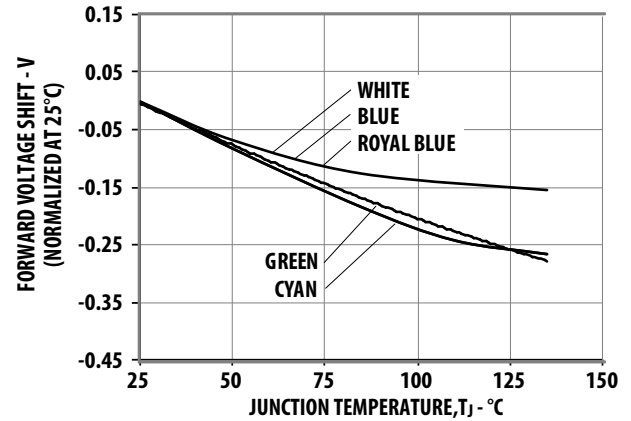
**Figure 25 Maximum Forward Current vs. Ambient Temperature. Derated based on  $T_{JMAX} = 135^\circ\text{C}$ ,  $R_{\theta J-A} = 30^\circ\text{C/W}$ ,  $40^\circ\text{C/W}$  and  $50^\circ\text{C/W}$ .**



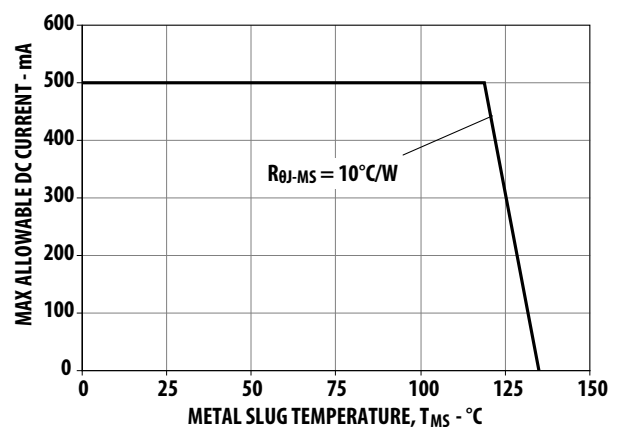
**Figure 22 Maximum Pulse Current vs. Pulse Duration. Derated based on  $T_A = 85^\circ\text{C}$ ,  $R_{\theta J-A} = 50^\circ\text{C/W}$ .**



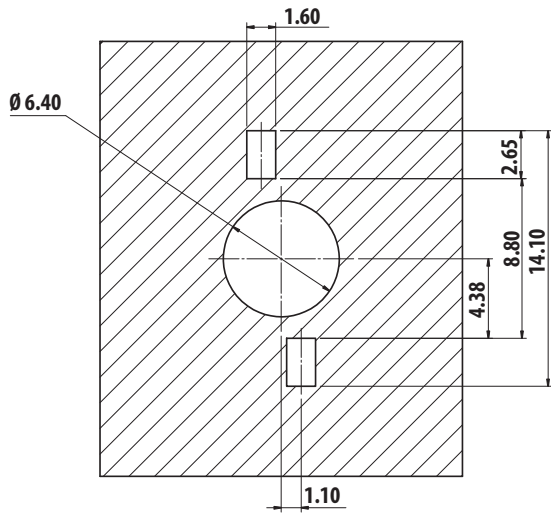
**Figure 24 Forward Voltage Shift vs. Junction Temperature**



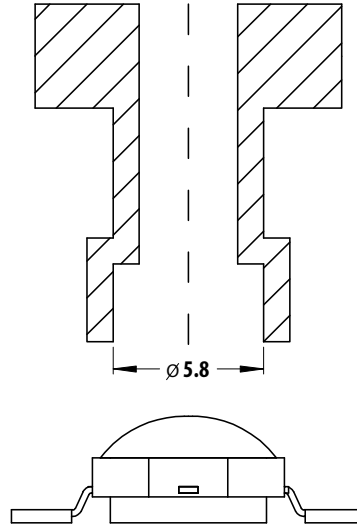
**Figure 26 Maximum Forward Current vs. Metal Slug Temperature. Derated based on  $T_{JMAX} = 135^\circ\text{C}$ ,  $R_{\theta J-MS} = 10^\circ\text{C/W}$ .**



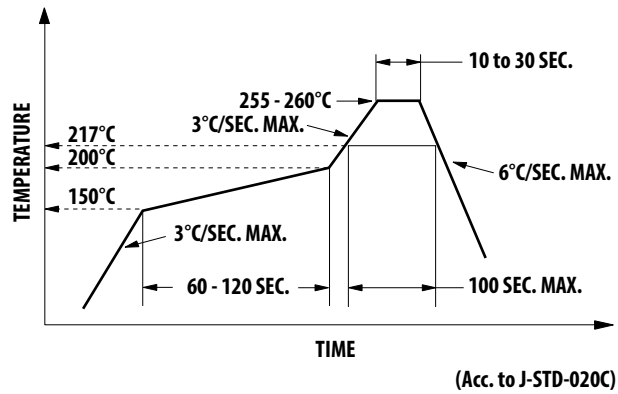
**Figure 27 Recommended Soldering Land Pattern**



**Figure 28 Recommended Pick and Place Nozzle Tip. Inner diameter = 5.8 mm.**



**Figure 29 Recommended Soldering Profile**

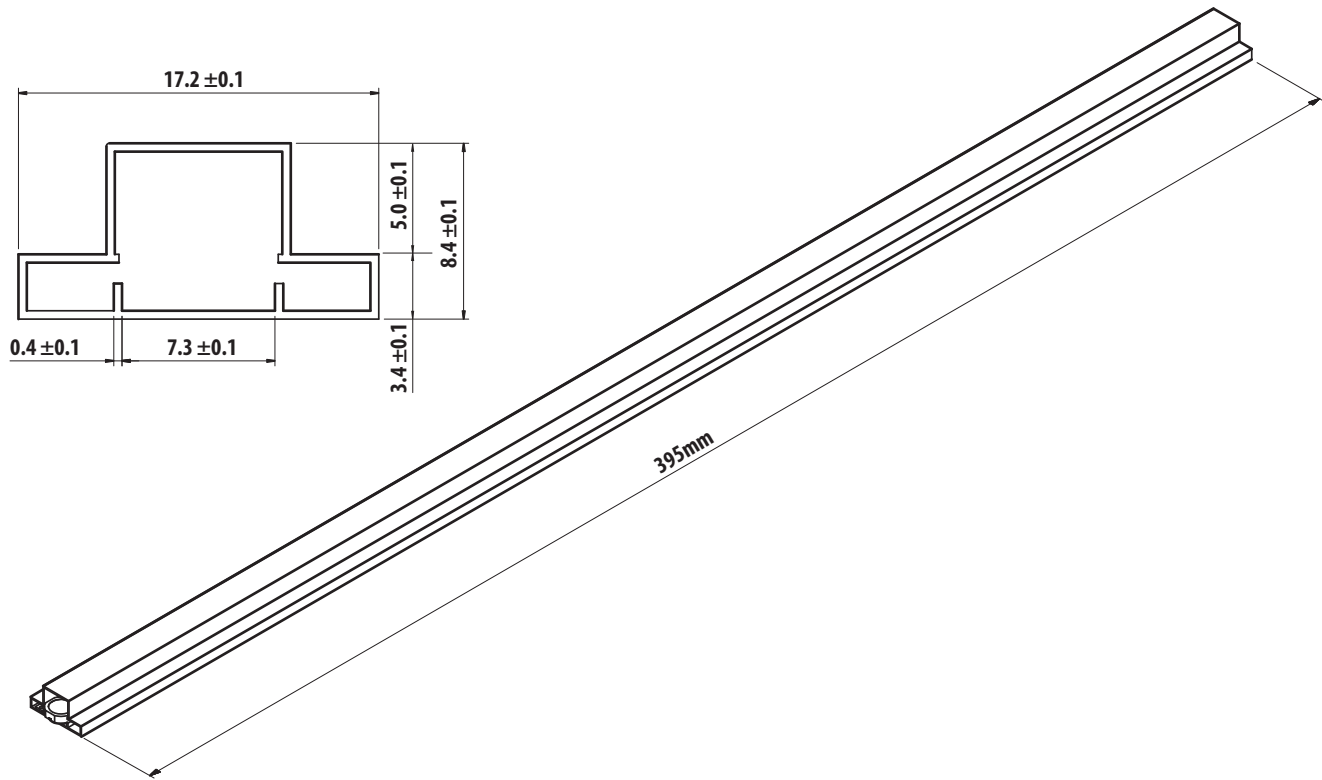


**NOTE** For detailed information on reflow soldering of Broadcom surface-mount LEDs, refer to Broadcom Application Note AN1060, *Surface Mounting SMT LED Indicator Components*.



## Packing Tube – Option 0

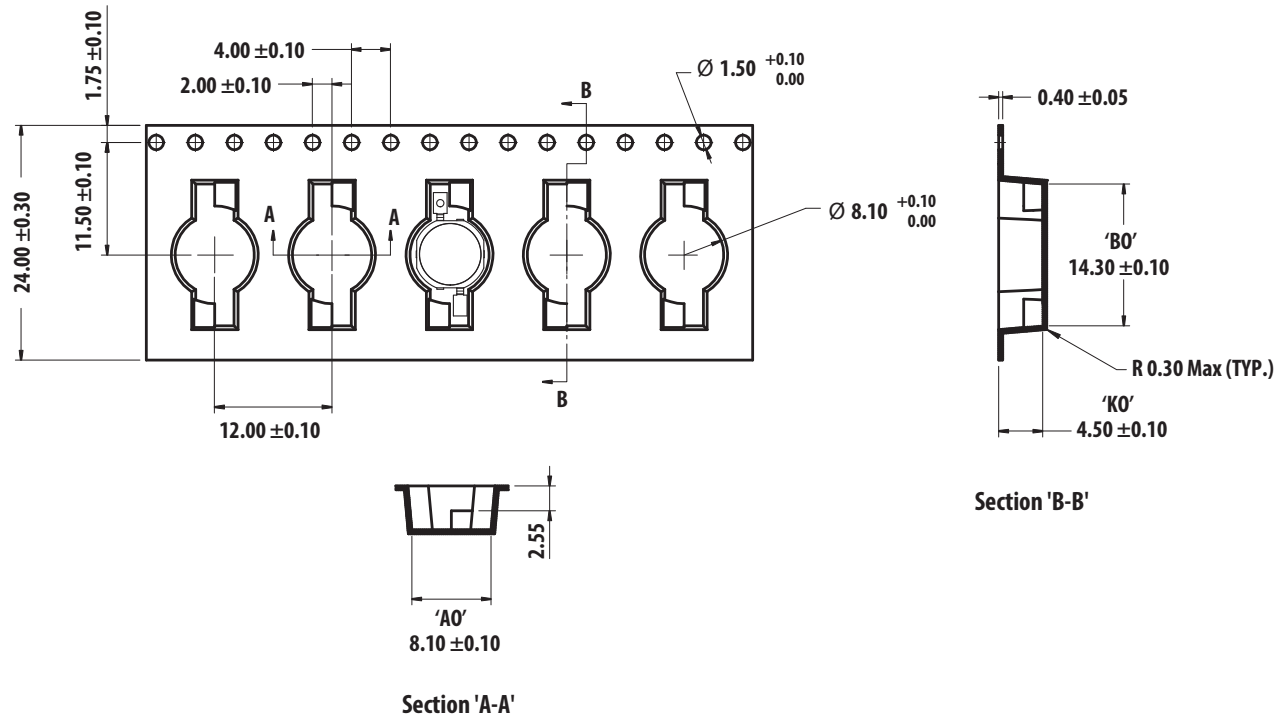
Figure 30 Packing Tube Dimensions



**NOTE** All dimensions are in millimeters.

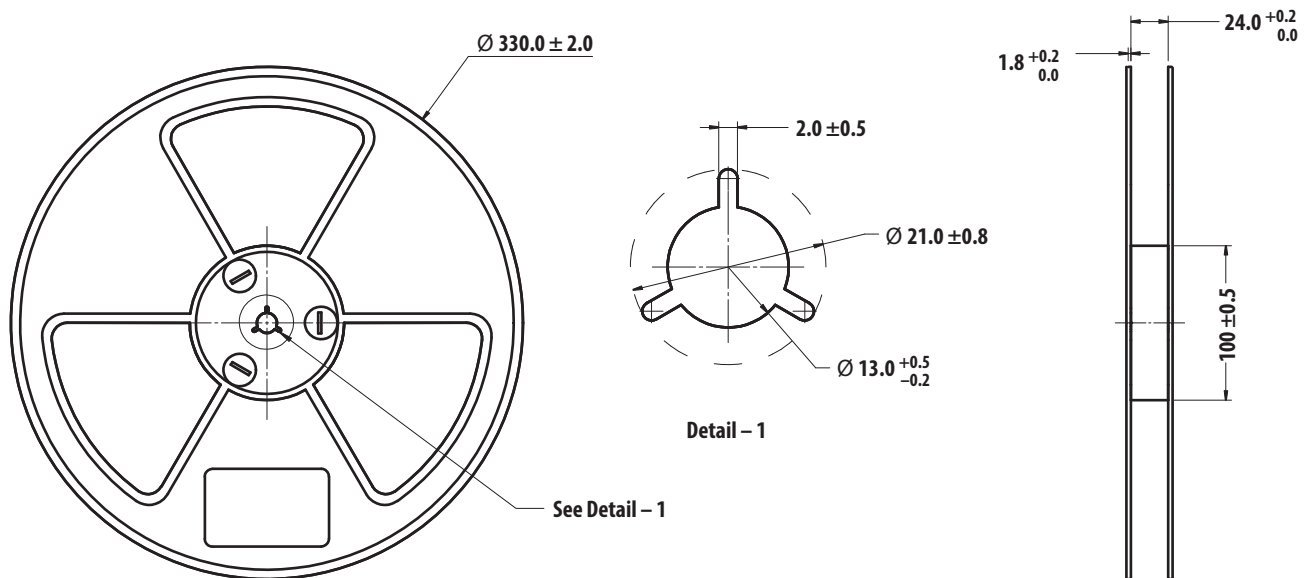
## Tape and Reel – Option 1

Figure 31 Carrier Tape Dimensions



**NOTE** All dimensions are in millimeters.

Figure 32 Reel Dimensions



**NOTE** All dimensions are in millimeters.

## Precautionary Notes

### Handling Precaution

The encapsulation material of the LED is made of silicone for better product reliability. Compared to epoxy encapsulant, which is hard and brittle, silicone is softer and flexible. Observe special handling precautions during assembly of silicone encapsulated LED products. Failure to comply might lead to damage and premature failure of the LED. Refer to Broadcom Application Note AN5288, *Silicone Encapsulation for LED: Advantages and Handling Precautions*, for additional information.

- Do not poke sharp objects into the silicone encapsulant. Sharp objects, such as tweezers or syringes, might apply excessive force or even pierce through the silicone and induce failures to the LED die or wire bond.
- Do not touch the silicone encapsulant. Uncontrolled force acting on the silicone encapsulant might result in excessive stress on the wire bond. Hold the LED only by the body.
- Do not stack assembled PCBs together. Use an appropriate rack to hold the PCBs.
- Surface of silicone material attracts dust and dirt easier than epoxy due to its surface tackiness. To remove foreign particles on the surface of silicone, use a cotton bud with isopropyl alcohol (IPA). During cleaning, rub the surface gently without putting too much pressure on the silicone. Ultrasonic cleaning is not recommended.

### Moisture Sensitivity

This product has a Moisture Sensitive Level 2a rating per JEDEC J-STD-020. Refer to Broadcom Application Note AN5305, *Handling of Moisture Sensitive Surface Mount Devices*, for additional details and a review of proper handling procedures.

- Before use:
  - An unopened moisture barrier bag (MBB) can be stored at < 40°C/90% RH for 12 months. If the actual shelf life has exceeded 12 months and the humidity indicator card (HIC) indicates that baking is not required, then it is safe to reflow the LEDs per the original MSL rating.
  - Do not open the MBB prior to assembly (for example, for IQC). If unavoidable, MBB must be properly resealed with fresh desiccant and HIC. The exposed duration must be taken in as floor life.

- Control after opening the MBB:
  - Read the HIC immediately upon opening of MBB.
  - Keep the LEDs at < 30°/60% RH at all times, and complete all high temperature-related processes, including soldering, curing or rework within 672 hours.
- Control for unfinished reel:
 

Store unused LEDs in a sealed MBB with desiccant or a desiccator at <5% RH.
- Control of assembled boards:
 

If the PCB soldered with the LEDs is to be subjected to other high-temperature processes, store the PCB in a sealed MBB with desiccant or desiccator at <5% RH to ensure that all LEDs have not exceeded their floor life of 672 hours.
- Baking is required if:
  - The HIC indicates a change in color for 10% and 5%, as stated on the HIC.
  - The LEDs are exposed to conditions of >30°C/60% RH at any time.
  - The LED's floor life exceeded 672 hours.

The recommended baking condition is: 60°C ± 5°C for 20 hours.

Baking can only be done once.
- Storage:
 

The soldering terminals of these Broadcom LEDs are silver plated. If the LEDs are exposed in ambient environment for too long, the silver plating might be oxidized, thus affecting its solderability performance. As such, keep unused LEDs in a sealed MBB with desiccant or in a desiccator at <5% RH.

**DISCLAIMER:** Broadcom's products and software are not specifically designed, manufactured, or authorized for sale as parts, components, or assemblies for the planning, construction, maintenance, or direct operation of a nuclear facility or for use in medical devices or applications. The customer is solely responsible, and waives all rights to make claims against Broadcom or its suppliers, for all loss, damage, expense, or liability in connection with such use.

---

For product information and a complete list of distributors, please go to our web site: [www.broadcom.com](http://www.broadcom.com).

Broadcom, the pulse logo, Connecting everything, Avago Technologies, Avago, and the A logo are among the trademarks of Broadcom and/or its affiliates in the United States, certain other countries and/or the EU.

Copyright © 2015–2017 by Broadcom. All Rights Reserved.

The term "Broadcom" refers to Broadcom Limited and/or its subsidiaries. For more information, please visit [www.broadcom.com](http://www.broadcom.com).

Broadcom reserves the right to make changes without further notice to any products or data herein to improve reliability, function, or design.

Information furnished by Broadcom is believed to be accurate and reliable. However, Broadcom does not assume any liability arising out of the application or use of this information, nor the application or use of any product or circuit described herein, neither does it convey any license under its patent rights nor the rights of others.

AV02-1640EN – May 5, 2017



## X-ON Electronics

Largest Supplier of Electrical and Electronic Components

*Click to view similar products for [High Power LEDs - White category:](#)*

*Click to view products by [Broadcom manufacturer:](#)*

Other Similar products are found below :

[LTW-K140SZR40](#) [B42180-08](#) [STW8Q2PA-R5-HA](#) [LTPL-P00DWS57](#) [LTW-K140SZR30](#) [LZP-D0WW00-0000](#) [SZ5-M1-WW-C8-V1/V3-FA](#) [LTW-K140SZR57](#) [LTW-K140SZR27](#) [BXRE-50C2001-C-74](#) [MP-5050-8100-27-80](#) [MP-5050-6100-65-80](#) [MP-5050-6100-50-80](#) [MP-5050-6100-40-80](#) [MP-5050-6100-30-80](#) [KW DPLS32.SB-6H6J-E5P7-EG-Z264](#) [L1V1-507003V500000](#) [KW DMLS33.SG-Z6M7-EBVFFCBB46-8E8G-700-S](#) [ASMT-MW05-NMNS1](#) [KW DPLS33.KD-HIJG-D30D144-HN-22C2-120-S](#) [KW DDLM31.EH-5J6K-A737-W4A4-140-R18](#) [GW JTLRS1.CM-K1LW-XX57-1-100-Q-R33](#) [KW DDLM31.EH-5J6K-A636-W4A4-140-R18](#) [KW DDLM31.EH-5J6K-A131-W4A4-140-R18](#) [SML-LXL8047MWCTR/3](#) [L2C5-40HG1203E0900](#) [JB3030AWT-P-U27EA0000-N0000001](#) [JK3030AWT-P-U30EA0000-N0000001](#) [JK3030AWT-P-B40EB0000-N0000001](#) [JK3030AWT-P-H30EB0000-N0000001](#) [JK3030AWT-P-H40EB0000-N0000001](#) [JK3030AWT-P-U27EB0000-N0000001](#) [JK3030AWT-P-U30EB0000-N0000001](#) [XPGBWT-HE-0000-00JE5](#) [GW JCLPS2.EM-H3H8-A131-1-65-2-R33](#) [GW PUSTA1.PM-PAPC-XX53-1-1050-R18](#) [BXRE-30E4000-C-83](#) [BXRE-50C6501-D-84](#) [BXRE-27E1000-B-83](#) [BXRE-30G0800-D-83](#) [BXRE-50C4001-B-84](#) [BXRH-40E4000-F-83](#) [BXRH-27G4000-F-83](#) [GW CSSRM2.PM-N3N5-XX53-1](#) [GW P9LMS1.EM-NRNU-30S7-0-200-R18](#) [GW PSLPS1.EC-KSKU-5R8T-1](#) [LTPL-M03614ZS50-F1](#) [LTW-2835SZK65](#) [LTW-3030AQL40](#) [LTW-3030AZL40-EU](#)