

## ASMT-TxBM-Nxxxx

### Surface-Mount LED Indicator



### Description

The Broadcom<sup>®</sup> ASMT-TxBM-Nxxxx Mini PLCC-2 SMT LEDs are designed specifically for use in interior automotive applications. They have a wide viewing angle of 120°, making them ideally suited for instrument cluster panel, push button, HVAC, and ambient decorative lighting applications in automotive interiors.

The LEDs are packed in EIA-compliant tape and reel to facilitate easy pick and place assembly. Every reel will be shipped in single intensity and color bin, to provide close uniformity.

### Features

- Industry standard Mini PLCC-2
- High reliability LED package
- High brightness using InGaN dice technologies
- High optical efficiency
- Wide vertical viewing angle at 120°
- Available in 8-mm carrier tape on 7-inch reel
- Stable and consistent performance with minimum degradation
- JEDEC MSL 2

### Applications

- Interior automotive
  - Instrument panel backlighting
  - Central console backlighting
  - Switch/push button backlighting

**CAUTION!** ASMT-TxBM-Nxxxx LED is Class 1B ESD sensitive. Please observe appropriate precautions during handling and processing. Refer to Broadcom Application Note AN-1142 for additional details.

Figure 1: Package Drawing

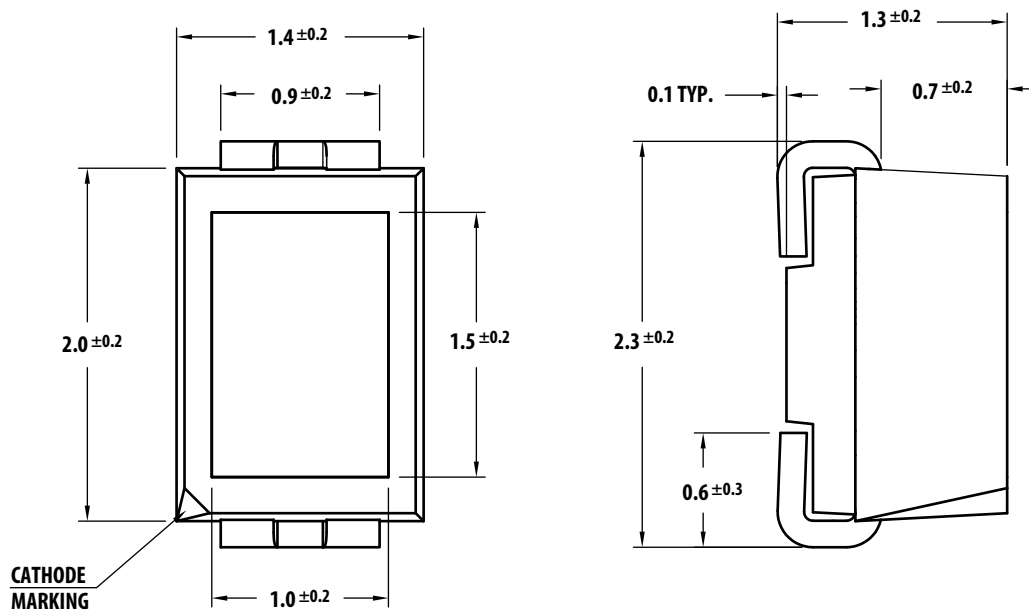

## Device Selection Guide

Color	Part Number	Min. I <sub>v</sub> (mcd)	Typ. I <sub>v</sub> (mcd)	Max. I <sub>v</sub> (mcd)	Test Current (mA)	Dice Technology
Blue	ASMT-TBBM-NS402	180.0	—	450.0	20	InGaN
Green	ASMT-TGBM-NT502	285.0	480.0	900.0	20	InGaN
Green	ASMT-TGBM-NU3B2	450.0	—	900.0	20	InGaN

**NOTE:**

1. The luminous intensity, I<sub>v</sub>, is measured at the mechanical axis of the lamp package. The actual peak of the spatial radiation pattern may not be aligned with this axis.
2. Tolerance = ±12%.

## Part Numbering System

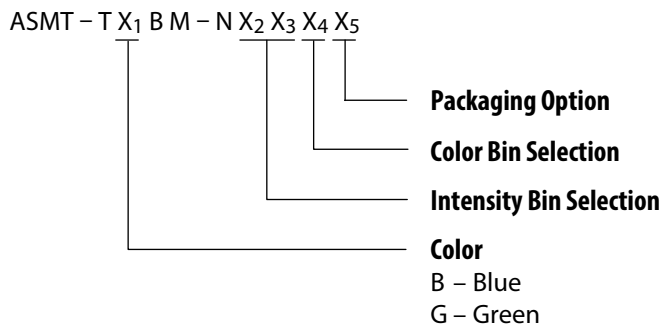

## Absolute Maximum Ratings ( $T_A = 25^\circ\text{C}$ )

Parameters	ASMT-TBBM-Nxxxx	ASMT-TGBM-Nxxxx
DC Forward Current <sup>a</sup>	20 mA	
Peak Forward Current <sup>b</sup>	100 mA	
Power Dissipation	72 mW	
Reverse Voltage, $V_R$ @ 10 mA	Not Recommended for Reverse Bias	
Junction Temperature	110°C	125°C
Operating Temperature	-40°C to +100°C	
Storage Temperature	-40°C to +100°C	

a. Derate linearly as shown in [Figure 6](#).

b. Duty Factor = 10%, Frequency = 1kHz.

## Optical Characteristics ( $T_J = 25^\circ\text{C}$ )

Color	Part Number	Dice Technology	Peak Wavelength $\lambda_{\text{PEAK}}$ (nm)	Dominant Wavelength <sup>a</sup> $\lambda_D$ (nm)	Vertical Viewing Angle $2\theta_{1/2}$ <sup>b</sup> (Degrees)	Total Flux/ Luminous Intensity $\Phi_V$ (lm) / $I_V$ (cd)
			Typ.	Typ.	Typ.	Typ.
Blue	ASMT-TBBM-Nxx02	InGaN	459.5	465.0	120	2.8
Green	ASMT-TGBM-Nxx02	InGaN	516.0	522.0	120	2.8

a. The dominant wavelength,  $\lambda_D$ , is derived from the CIE Chromaticity diagram and represents the color of the device.

b.  $\theta_{1/2}$  is the off-axis angle where the luminous intensity is half of the peak intensity.

## Electrical Characteristics ( $T_J = 25^\circ\text{C}$ )

Part Number	Forward Voltage $V_F$ (Volts) @ $I_F = 20$ mA			Thermal Resistance $R_{\theta_{JP}}$ ( $^\circ\text{C}/\text{W}$ )
	Min.	Typ.	Max.	
ASMT-TBBM-Nxxx2	2.8	3.2	3.6	230
ASMT-TGBM-Nxxx2	2.9	3.3	4.0	230

Figure 2: Relative Intensity vs. Wavelength

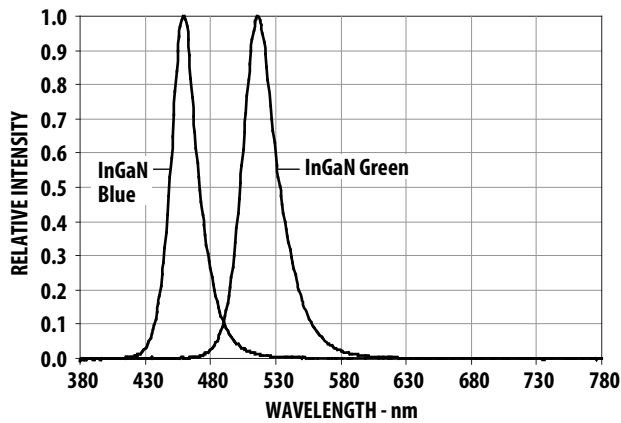

Figure 3: Forward Current vs. Forward Voltage

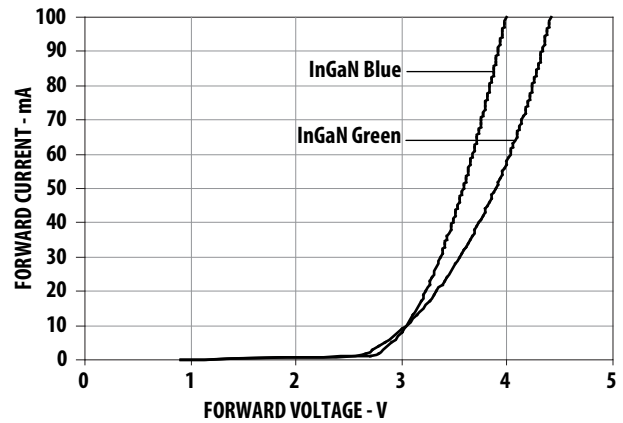

Figure 4: Relative Luminous Intensity vs. Forward Current

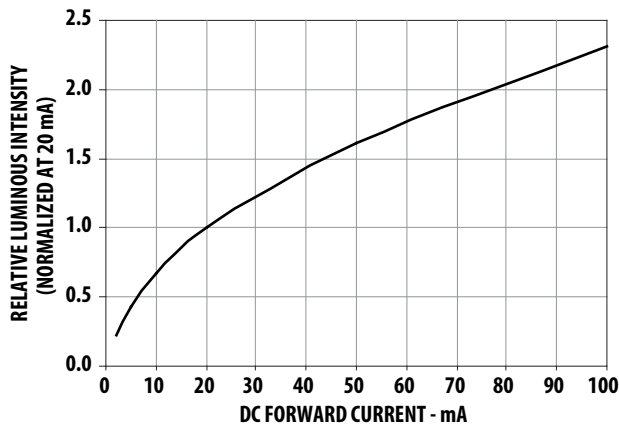

Figure 5: Relative Intensity vs. Temperature

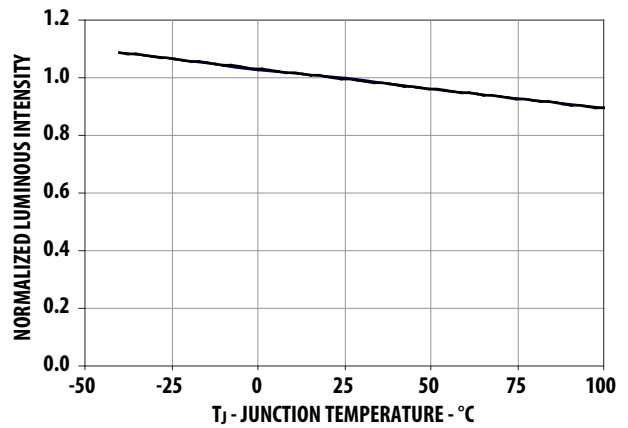

Figure 6: Maximum Forward Current Vs. Ambient Temperature. Derate Based on T<sub>JMAX</sub> = 110°C, R<sub>θJA</sub> = 850°C/W, 480°C/W.

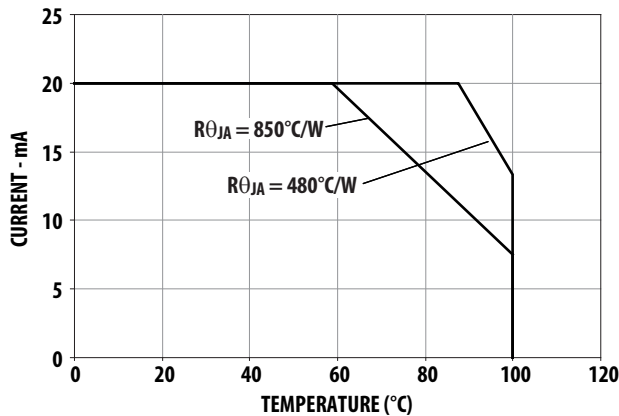

Figure 7: Dominant Wavelength Shift vs. Forward Current

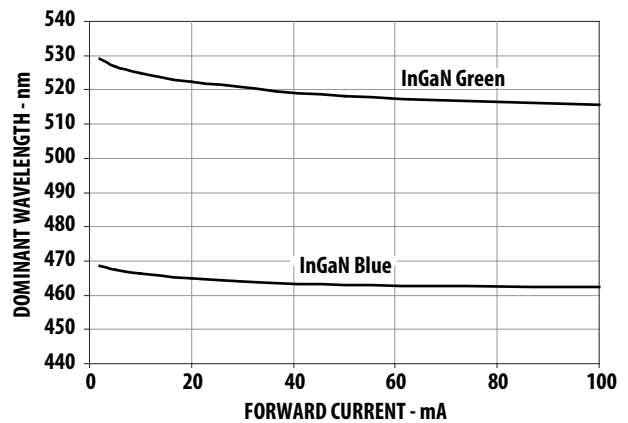

Figure 8: Forward Voltage Shift vs. Temperature

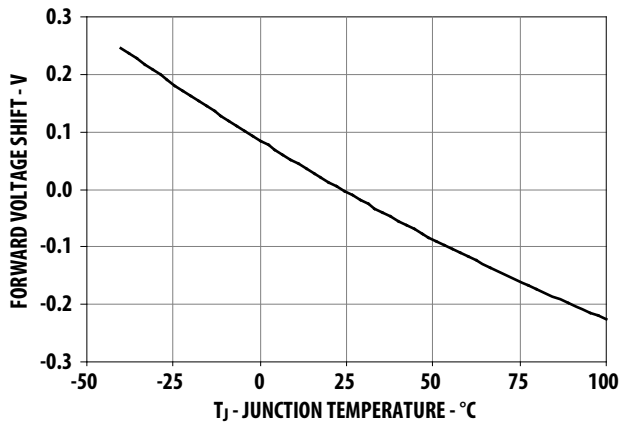

Figure 9: Radiation Pattern

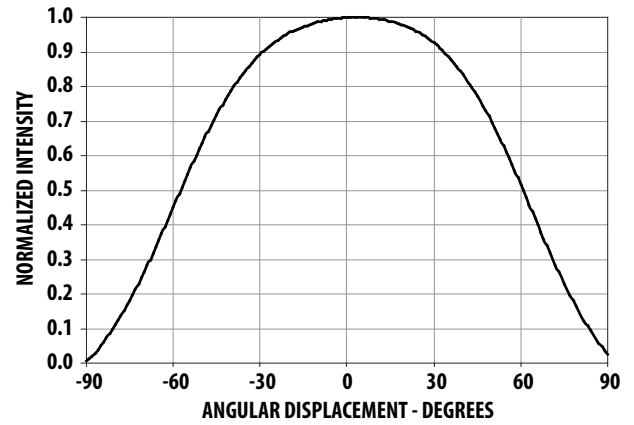

Figure 10: Recommended SnPb Reflow Soldering Profile

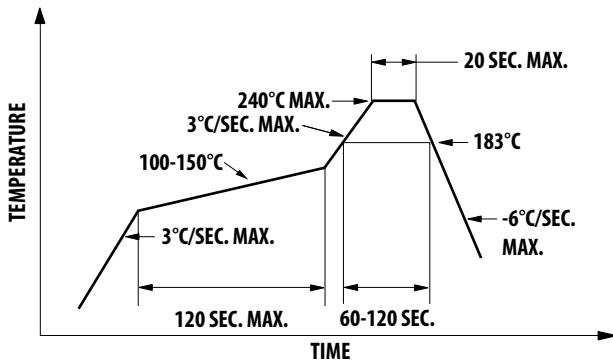

Figure 11: Recommended Pb-Free Soldering Profile

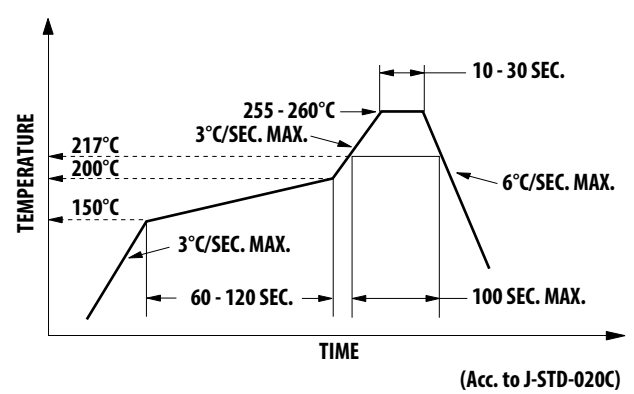

Figure 12: Recommended Soldering Pad Pattern

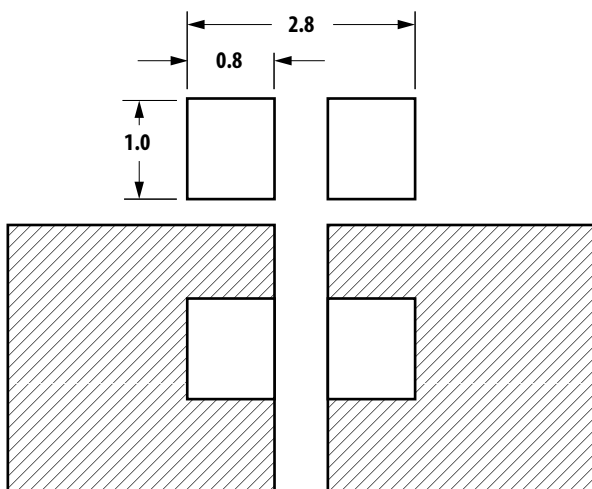

Figure 13: Tape Leader and Trailer Dimensions

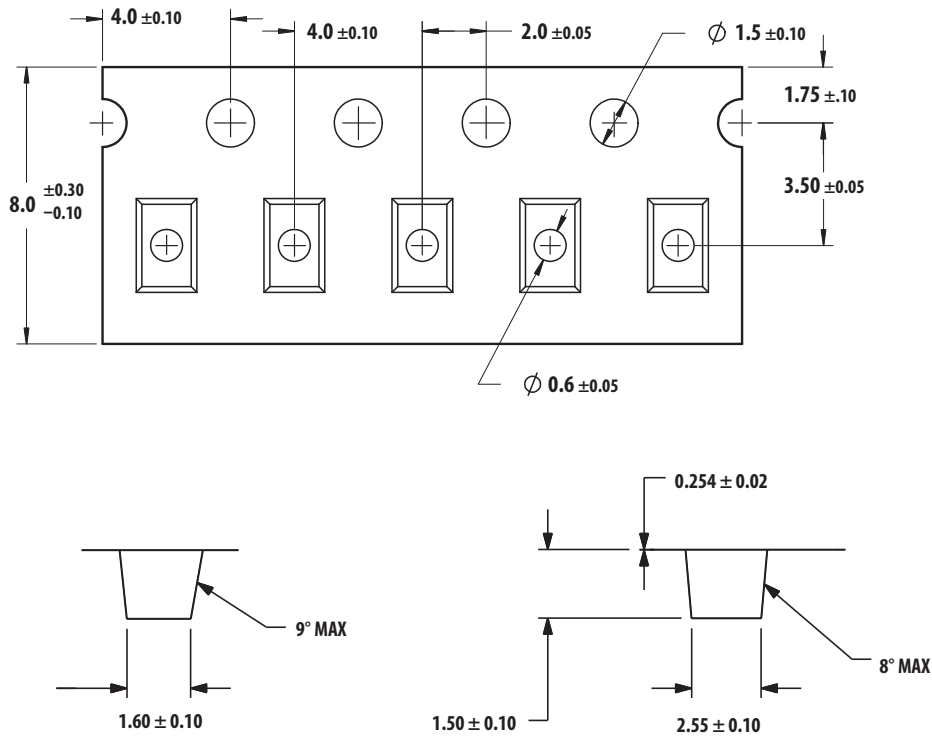
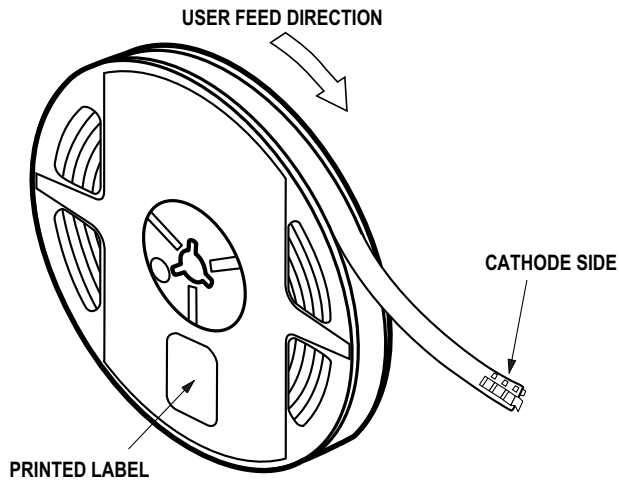

Figure 14: Reeling Orientation



## Handling Precautions

The encapsulation material of the product is made of silicone for better reliability of the product. As silicone is a soft material; do not press on the silicone or poke a sharp object onto the silicone. These actions might damage the product and cause premature failure. During assembly or handling, the unit should be held on the body only. Refer to Broadcom Application Note AN 5288 for detail information.

- Do not poke sharp objects into the silicone encapsulant. Sharp objects, such as tweezers or syringes, might apply excessive force or even pierce through the silicone and induce failures to the LED die or wire bond.
- Do not touch the silicone encapsulant. Uncontrolled force acting on the silicone encapsulant might result in excessive stress on the wire bond. Hold the LED only by the body.
- Do not stack assembled PCBs together. Use an appropriate rack to hold the PCBs.
- The surface of the silicone material attracts dust and dirt easier than epoxy due to its surface tackiness. To remove foreign particles on the surface of silicone, use a cotton bud with isopropyl alcohol (IPA). During cleaning, rub the surface gently without putting much pressure on the silicone. Ultrasonic cleaning is not recommended.

## Moisture Sensitivity

This product is qualified as Moisture Sensitive Level 2a per JEDEC J-STD-020. Precautions when handling this moisture-sensitive product are important to ensure the reliability of the product. Refer to Broadcom Application Note AN5305, *Handling of Moisture Sensitive Surface Mount Devices*, for details.

- Storage before use
  - Unopen moisture barrier bag (MBB) can be stored at < 40°C / 90% RH for 12 months. If the actual shelf life has exceeded 12 months and the humidity indicator card (HIC) indicates that baking is not required, it is safe to reflow the LEDs per the original MSL rating.
  - It is not recommended to open the MBB prior to assembly (for example, for IQC).
- Control after opening the MBB
  - Read the HIC immediately upon opening the MBB.
  - Keep the LEDs at <30°C / 60% RH at all times and all high temperature-related processes, including soldering, curing, or rework, must be completed within 672 hours.

- Control for unfinished reel
  - Store any unused LEDs in a sealed MBB with desiccant or desiccator at < 5% RH.
- Control of assembled boards
  - If the PCB soldered with LEDs is to be subjected to other high-temperature processes, the PCB must be stored in a sealed MBB with desiccant or desiccator at < 5% RH to ensure no LEDs have exceeded their floor life of 672 hours.
- Baking is required if:
  - The HIC is *not* GREEN at 10% and is AZURE at 5%
  - The LEDs are exposed to condition of > 30°C / 60% RH at any time.
  - The LEDs floor life exceeded 672 hours.
 Recommended baking condition: 60°C ± 5°C for 20 hours.

## Application Precautions

- The drive current of the LED must not exceed the maximum allowable limit across temperature as stated in the data sheet. Constant current driving is recommended to ensure consistent performance.
- LEDs exhibit slightly different characteristics at different drive currents that might result in larger variations in their performance (that is, intensity, wavelength, and forward voltage). Set the application current as close as possible to the test current to minimize these variations.
- The LED is not intended for reverse bias. Use other appropriate components for such purposes. When driving the LED in matrix form, it is crucial to ensure that the reverse bias voltage does not exceed the allowable limit of the LED.
- Do not use the LED in the vicinity of material with sulfur content, in environments of high gaseous sulfur compounds and corrosive elements. Examples of material that may contain sulfur are rubber gasket, RTV (room temperature vulcanizing) silicone rubber, rubber gloves, and so on. Prolonged exposure to such environments may affect the optical characteristics and product life.
- Avoid rapid changes in ambient temperature, especially in high humidity environments, as this will cause condensation on the LED.

## Eye Safety Precautions

LEDs may pose optical hazards when in operation. It is not advisable to view directly at operating LEDs as it may be harmful to the eyes. For safety reasons, use appropriate shielding or personal protective equipments.

## Device Color (X<sub>1</sub>)

B	Blue
G	Green

## Intensity Bin Select (X<sub>2</sub>X<sub>3</sub>)

Individual reel will contain parts from one half bin only.

X <sub>2</sub>	
	Min I <sub>V</sub> Bin

X <sub>3</sub>	
0	Full Distribution
2	2 half bins starting from X <sub>2</sub> 1
3	3 half bins starting from X <sub>2</sub> 1
4	4 half bins starting from X <sub>2</sub> 1
5	5 half bins starting from X <sub>2</sub> 1
6	2 half bins starting from X <sub>2</sub> 2
7	3 half bins starting from X <sub>2</sub> 2
8	4 half bins starting from X <sub>2</sub> 2
9	5 half bins starting from X <sub>2</sub> 2

## Intensity Bin Limits

Bin ID	Min. (mcd)	Max. (mcd)
P1	45.0	56.0
P2	56.0	71.5
Q1	71.5	90.0
Q2	90.0	112.5
R1	112.5	140.0
R2	140.0	180.0
S1	180.0	224.0
S2	224.0	285.0
T1	285.0	355.0
T2	355.0	450.0
U1	450.0	560.0
U2	560.0	715.0
V1	715.0	900.0
V2	900.0	1125.0

Tolerance of each bin limit = ± 12%

## Color Bin Select (X<sub>4</sub>)

Individual reel will contain parts from one sub bin only.

X <sub>4</sub>	
0	Full Distribution
A	1 and 2 only
B	2 and 3 only
C	3 and 4 only
G	1, 2, and 3 only
H	2, 3, and 4 only
Z	Special binning

## Color Bin Limits

Blue	Min. (nm)	Max. (nm)
1	460.0	465.0
2	465.0	470.0
3	470.0	475.0
4	475.0	480.0

Green	Min. (nm)	Max. (nm)
1	515.0	520.0
2	520.0	525.0
3	525.0	530.0
4	530.0	535.0

## Packaging Option (X<sub>5</sub>)

Option	Test Current	Package Type	Reel Size
2	20 mA	Top Mount	7 Inch



Broadcom, the pulse logo, Connecting everything, Avago Technologies, Avago, and the A logo are among the trademarks of Broadcom and/or its affiliates in the United States, certain other countries, and/or the EU.

Copyright © 2014–2018 Broadcom. All Rights Reserved.

The term “Broadcom” refers to Broadcom Limited and/or its subsidiaries. For more information, please visit [www.broadcom.com](http://www.broadcom.com).

Broadcom reserves the right to make changes without further notice to any products or data herein to improve reliability, function, or design. Information furnished by Broadcom is believed to be accurate and reliable. However, Broadcom does not assume any liability arising out of the application or use of this information, nor the application or use of any product or circuit described herein, neither does it convey any license under its patent rights nor the rights of others.



## X-ON Electronics

Largest Supplier of Electrical and Electronic Components

*Click to view similar products for [Standard LEDs - SMD category](#):*

*Click to view products by [Broadcom manufacturer](#):*

Other Similar products are found below :

[LTST-C19GD2WT](#) [LTST-N683GBEW](#) [LTW-170ZDC](#) [LTW-M140SZS40](#) [598-8110-100F](#) [598-8170-100F](#) [598-8610-202F](#) [67-22VRVGC/TR8](#) [AAAF5060QBFSEEZGS](#) [HLMP-6305-L0011](#) [ALMD-LB36-SV002](#) [APT1608QGW](#) [15-21UYC/S530-A3/TR8](#) [EASV1803BA0](#) [LS A676-P2S1-1](#) [SML310BATT86](#) [SML-512VWT86A](#) [SML-LX0606SISUGC/A](#) [SML-LXL1307SRC-TR](#) [SML-LXR851SIUPGUBC](#) [LT1ED53A](#) [FAT801-S](#) [AM27ZGC03](#) [APB3025SGNC](#) [APFA3010SURKCGKQBDC](#) [APHK1608VGCA](#) [APT2012QGW](#) [CLX6D-FKB-CN1R1H1BB7D3D3](#) [LTST-C250KGKT](#) [LTW-020ZDCG](#) [LTW-21TS5](#) [LTW-220DS5](#) [JANTXM19500/521-02](#) [UYGT801-S](#) [LO T67F-V1AB-24-1](#) [YGFR411-H](#) [SML-LX0402IC-TR](#) [CMDA20AYAA7D1S](#) [CMDA16AYDR7A1X](#) [339-1SURYGW/S530-A2](#) [598-8040-100F](#) [598-8070-100F](#) [598-8140-100F](#) [598-8610-200F](#) [EAPL3527GA5](#) [67-11/BHC-M1N2B8Y/2A0](#) [SML-LXL1209SYC/ATR](#) [EASV3020YGA0](#) [EAST16086YA5](#) [CMD91-21VRC/TR7](#)