

## ASMT-YTB2-0BB02

### High Brightness Tricolor PLCC-6 Black Surface LED

---

#### Description

The high brightness black top surface tricolor PLCC-6 family of SMT LEDs has a separate heat path for each LED dice, enabling the LED to be driven at higher current. These SMT LEDs are in the high brightness category, are high reliability devices, are high performance and are designed for a wide range of environmental conditions. By integrating the black top surface Broadcom<sup>®</sup> devices deliver better contrast enhancement for your application. They also provide super wide viewing angle at 120° with the built-in reflector pushing up the intensity of the light output. The high reliability characteristics and other features make the black top surface tricolor PLCC-6 family ideally suitable for exterior and interior full color signs application conditions.

For easy pick and place, the LEDs are shipped in EIA-compliant tape and reel. Every reel is shipped from a single intensity and color bin; except red color providing better uniformity. These tricolor LEDs are compatible with reflow soldering process.

**CAUTION!** LEDs are Class 1C ESD sensitive. Observe appropriate precautions during handling and processing. Refer to Broadcom Application Note AN-1142 for additional details.

#### Features

- Industry-standard PLCC-6 package (Plastic Leaded Chip Carrier) with individual addressable pinout for higher flexibility of driving configuration
- High reliability LED package with silicone encapsulation
- High brightness using AlInGaP and InGaN dice technologies
- Wide viewing angle at 120°
- Compatible with reflow soldering process
- JEDEC MSL 2a
- Water-resistant (IPX6, see note) per IEC 60529:2001

**NOTE:** The test is conducted on component level by mounting the components on PCB with proper potting to protect the leads. It is strongly recommended that customers perform necessary tests on the components for their final application.

#### Applications

- Indoor and outdoor full color display

# Package Dimensions

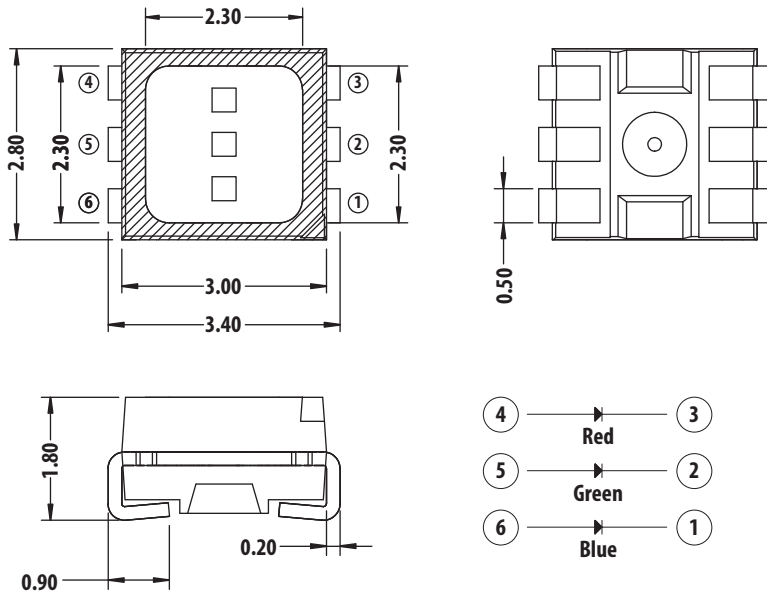

1. All dimensions are in millimeters.
2. Tolerance =  $\pm 0.2$  mm unless otherwise specified.
3. Terminal Finish: Ag plating.
4. Encapsulation material: silicone resin

Lead Configuration		
1	Cathode	Blue
2	Cathode	Green
3	Cathode	Red
4	Anode	Red
5	Anode	Green
6	Anode	Blue

## Device Selection Guide

Part Number	Color 1 – AlInGaP Red			Color 2 – InGaN Green			Color 3 – InGaN Blue					
	Min. $I_V$ at 20 mA		Typ. $I_V$ at 20 mA	Min. $I_V$ at 20 mA		Typ. $I_V$ at 20 mA	Min. $I_V$ at 20 mA		Typ. $I_V$ at 20 mA	Max $I_V$ at 20 mA		
	Bin ID	(mcd)	(mcd)	(mcd)	Bin ID	(mcd)	(mcd)	(mcd)	Bin ID	(mcd)	(mcd)	(mcd)
ASMT-YTB2-0BB02	U2	560	745	1125	X1	1800	2280	3550	T2	355	520	715

### NOTE:

- The luminous intensity,  $I_V$ , is measured at the mechanical axis of the LED package, and it is tested in pulsing condition. The actual peak of the spatial radiation pattern might not be aligned with this axis.
- Tolerance =  $\pm 12\%$ .

## Part Numbering System

A S M T - 

$x_1$	$x_2$	$x_3$
-------	-------	-------

 2 - 0 

$x_4$	$x_5$	$x_6$	$x_7$
-------	-------	-------	-------

Code	Description	Option	
$x_1$	Package Type	Y	Silicone-based PLCC-6
$x_2$	Color	T	Tricolor
$x_3$	Package Type	B	Black Surface
$x_4$	Minimum Intensity Bin	B	Red      Bin U2      Red      Bin U2, V1, V2
			Green      Bin X1      Green      Bin X1, X2, Y1
			Blue      Bin T2      Blue      Bin T2, U1, U2
$x_5$	Number of Intensity Bins	B	3 intensity bins from minimum
$x_6$	Color Bin Combination	0	Red      Full distribution
			Green      A, B, C
			Blue      A, B, C, D, E
$x_7$	Packaging Option	2	Test current = 20 mA, 7-in. reel size

## Absolute Maximum Ratings ( $T_A = 25^\circ\text{C}$ )

Parameter	Red	Green and Blue	Unit
DC Forward Current <sup>a</sup>	50	30	mA
Peak Forward Current <sup>b</sup>	100	100	mA
Power Dissipation	125	114	mW
Reverse Voltage	4V <sup>c</sup>		V
Maximum Junction Temperature $T_{j\text{max}}$	125		$^\circ\text{C}$
Operating Temperature Range	-40 to + 110 <sup>d</sup>		$^\circ\text{C}$
Storage Temperature Range	-40 to + 120		$^\circ\text{C}$

- Derate linearly as shown in Figure 4 and Figure 5.
- Duty Factor = 10% Frequency = 1 KHz.
- Driving the LED in reverse bias condition is suitable for short term only.
- Refer to Figure 4 and Figure 5 for more information.

## Optical Characteristics ( $T_A = 25^\circ\text{C}$ )

Color	Dominant Wavelength, $\lambda_d$ (nm) <sup>a</sup>			Peak Wavelength, $\lambda_p$ (nm)	Viewing Angle $2\theta_{1/2}$ <sup>b</sup> (Degrees)	Luminous Efficacy $\eta_V$ <sup>c</sup> (lm/W)	Luminous Efficiency $\eta_e$ (lm/W)
	Min	Typ.	Max	Typ.	Typ.	Typ.	Typ.
Red	618	622	628	629	120	210	43
Green	525	530	537	521	120	535	75
Blue	465	470	477	464	120	84	15

- The dominant wavelength is derived from the CIE Chromaticity Diagram and represents the perceived color of the device.
- $\theta_{1/2}$  is the off axis angle where the luminous intensity is  $1/2$  the peak intensity
- Radiant intensity,  $I_e$  in watts/steradian, can be calculated from the equation  $I_e = I_V / \eta_V$ , where  $I_V$  is the luminous intensity in candelas and  $\eta_V$  is the luminous efficacy in lumens/watt.

## Electrical Characteristics ( $T_A = 25^\circ\text{C}$ )

Color	Forward Voltage, $V_F$ (V) <sup>a</sup>			Reverse Voltage $V_R$ at 100 $\mu\text{A}$	Reverse Voltage $V_R$ at 10 $\mu\text{A}$	Thermal Resistance $R\theta_{J-P}$ ( $^\circ\text{C/W}$ ) <sup>b</sup>
	Min	Typ.	Max.	Min.	Min.	Typ
Red	1.80	2.0	2.50	4	—	280
Green	2.4	2.9	3.4	—	4	180
Blue	2.4	2.9	3.4	—	4	180

- Tolerance is  $\pm 0.1\text{V}$ .
- One chip on thermal resistance.

Figure 1: Relative Intensity vs. Wavelength

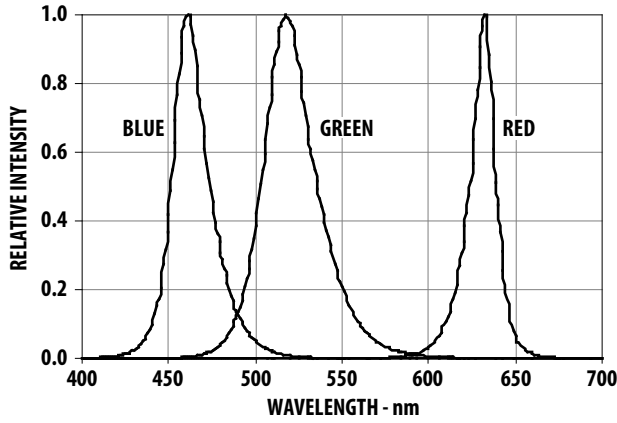

Figure 2: Forward Current vs. Forward Voltage

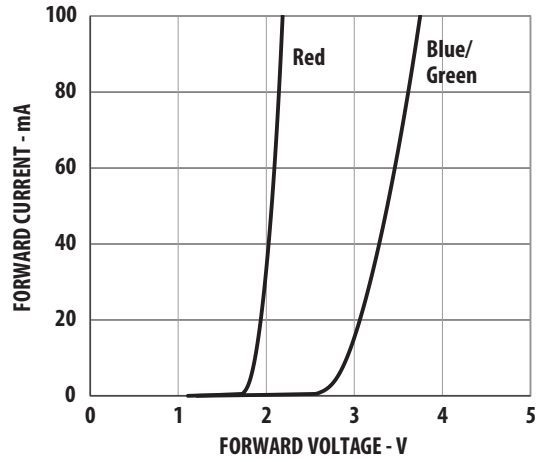

Figure 3: Relative Intensity vs. Forward Current

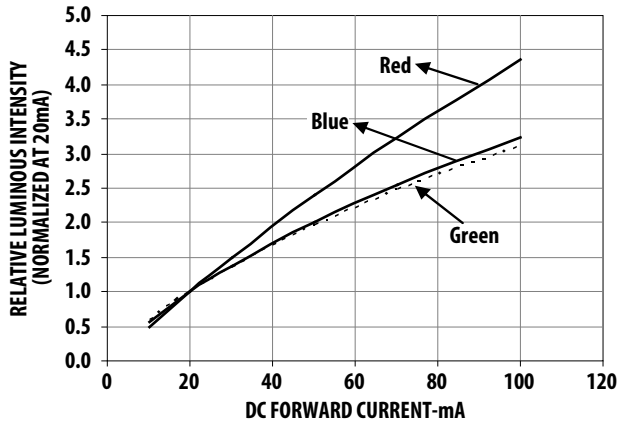

Figure 4: Maximum Forward Current vs Ambient Temperature. Derated based on  $T_{JMAX} = 125^{\circ}C$  (3 chips).

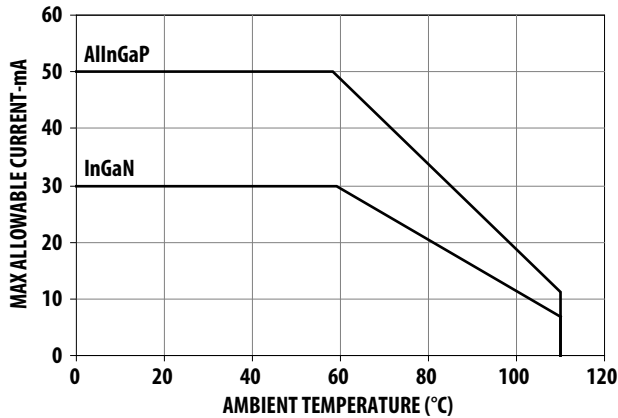

Figure 5: Maximum Forward Current vs Ambient Temperature. Derated based on  $T_{JMAX} = 125^{\circ}C$  (single chip).

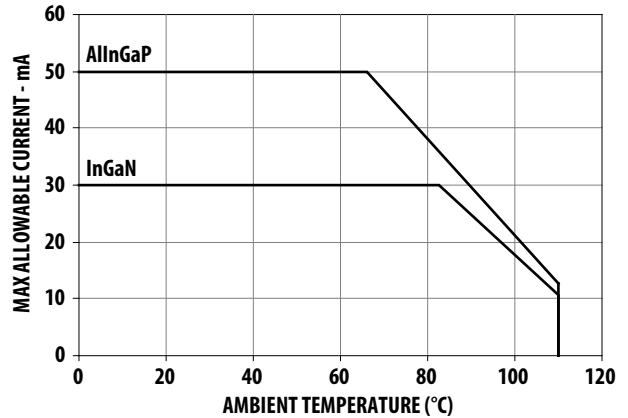

Figure 6: Radiation Pattern for X Axis

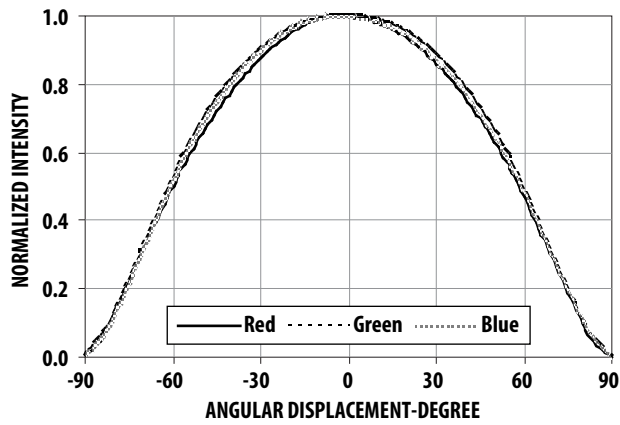

Figure 7: Radiation Pattern for Y Axis

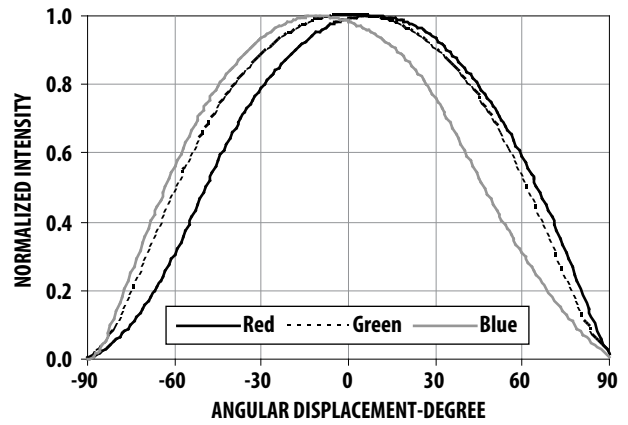

Figure 8: Component Access for Radiation Patterns

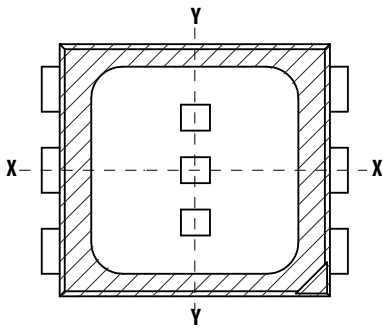

Figure 9: Relative Intensity vs. Junction Temperature

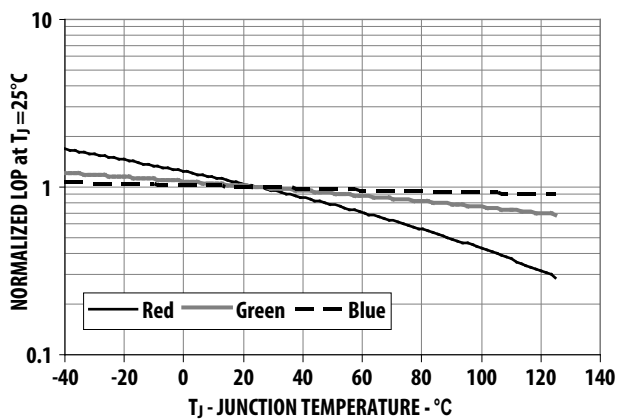

Figure 10: Forward Voltage vs. Junction Temperature

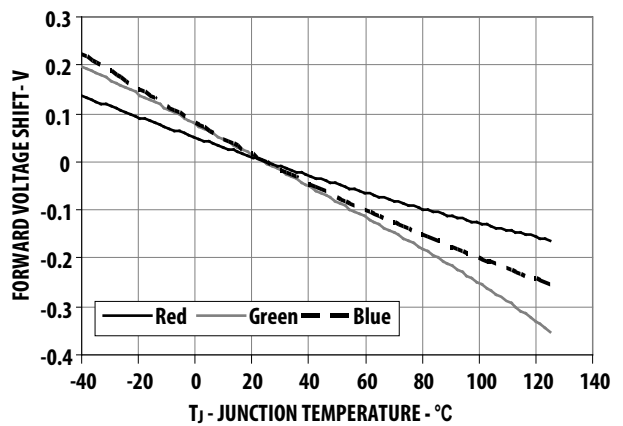



Figure 13: Reel Dimension

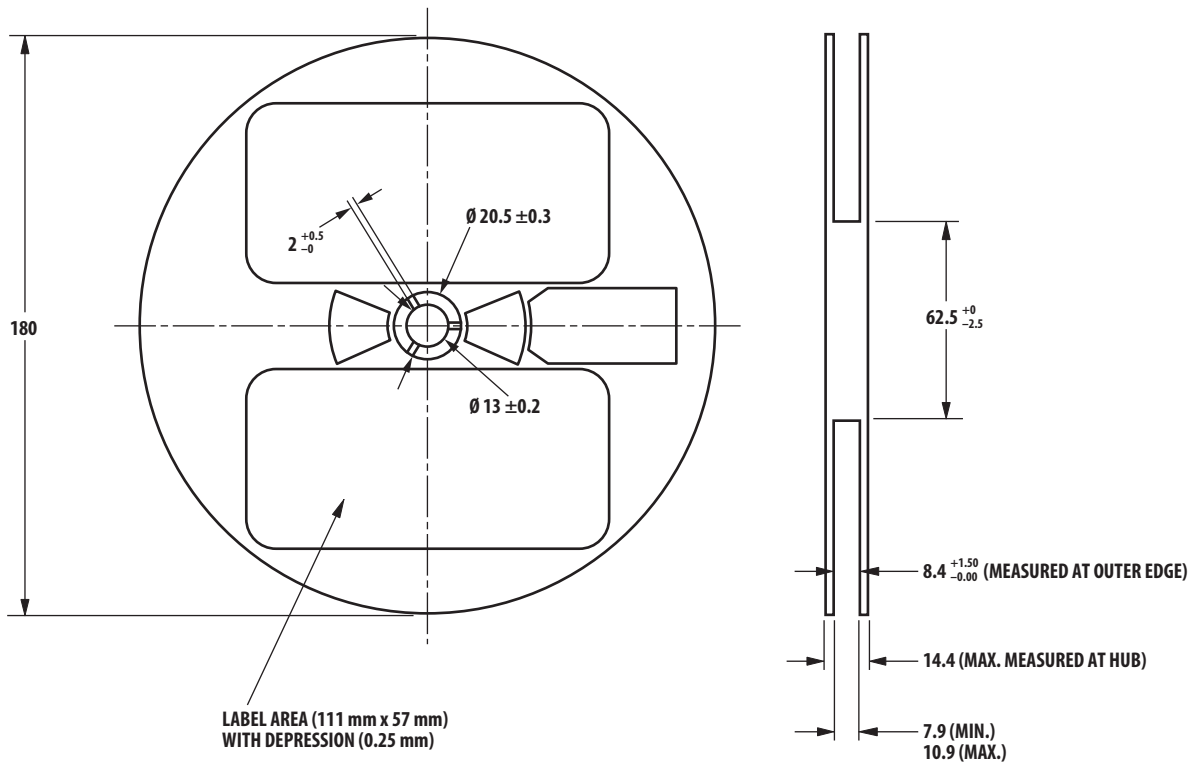
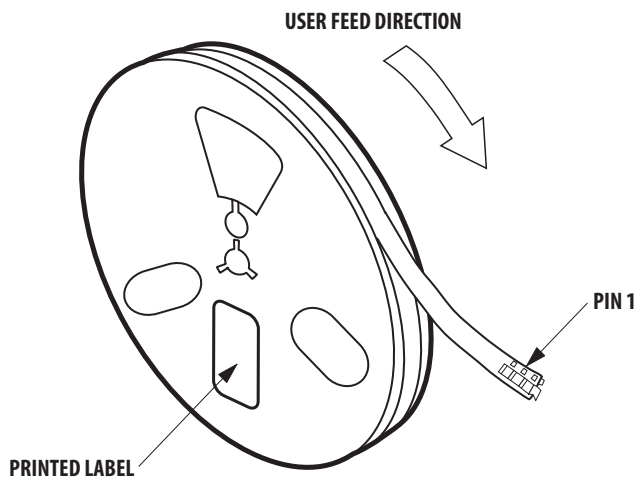

Figure 14: Reeling Orientation





## Intensity Bin Select ( $x_4$ , $x_5$ )

Individual reel will contain parts from 1 half bin only.

$x_4$	Min. I <sub>v</sub> Bin (Minimum Intensity Bin)		
	Red	Green	Blue
B	U2	X1	T2

$x_5$	Number of Half Bin from $X_2$		
	Red	Green	Blue
B	3	3	3

## Color Bin Select ( $x_6$ )

Individual reel will contain parts from 1 full bin only.

$x_6$	Color Bin Combinations		
	Red	Green	Blue
0	Full distribution	A, B, C	A, B, C, D, E

## Intensity Bin Limits

Bin ID	Min. (mcd)	Max. (mcd)
T1	285.0	355.0
T2	355.0	450.0
U1	450.0	560.0
U2	560.0	715.0
V1	705.0	900.0
V2	900.0	1125.0
W1	1125.0	1400.0
W2	1400.0	1800.0
X1	1800.0	2240.0
X2	2240	2850
Y1	2850	3550

**NOTE:** Tolerance of each bin limit is  $\pm 12\%$ .

## Color Bin Limits

### Red Color Bin Table

Bin ID	Min. Dom	Max. Dom					
Full Distribution	618	628	x	0.6873	0.6696	0.6866	0.7052
			y	0.3126	0.3136	0.2967	0.2948

Tolerance of each bin limit is  $\pm 1$  nm.

### Green Color Bin Table

Bin ID	Min. Dom	Max. Dom					
A	525.0	531.0	x	0.1142	0.1799	0.2138	0.1625
			y	0.8262	0.6783	0.6609	0.8012
B	528.0	534.0	x	0.1387	0.1971	0.2298	0.1854
			y	0.8148	0.6703	0.6507	0.7867
C	531.0	537.0	x	0.1625	0.2138	0.2454	0.2077
			y	0.8012	0.6609	0.6397	0.7711

Tolerance of each bin limit is  $\pm 1$  nm.

### Blue Color Bin Table

Bin ID	Min. Dom	Max. Dom					
A	465.0	469.0	x	0.1355	0.1751	0.168	0.127
			y	0.0399	0.0986	0.1094	0.053
B	467.0	471.0	x	0.1314	0.1718	0.1638	0.122
			y	0.0459	0.1034	0.1167	0.063
C	469.0	473.0	x	0.1267	0.168	0.1593	0.116
			y	0.0534	0.1094	0.1255	0.074
D	471.0	475.0	x	0.1215	0.1638	0.1543	0.1096
			y	0.0626	0.1167	0.1361	0.0868
E	473.0	477.0	x	0.1158	0.1593	0.1489	0.1028
			y	0.0736	0.1255	0.1490	0.1029

Tolerance of each bin limit is  $\pm 1$  nm.

### Packaging Option (x<sub>7</sub>)

Option	Test Current	Reel Size
2	20 mA	7 inch

# Soldering

Recommended reflow soldering condition:

## (i) Leaded reflow soldering

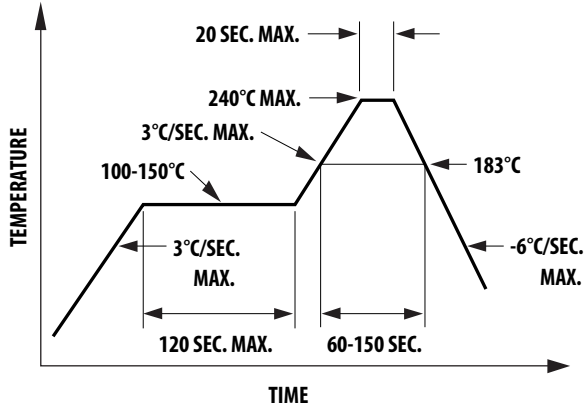

## (ii) Lead-free reflow soldering

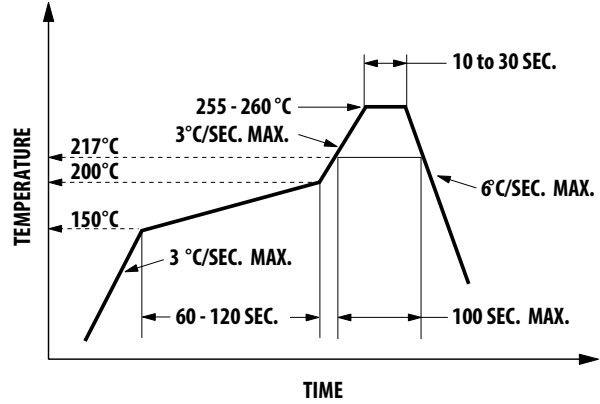

1. Reflow soldering must not be done more than twice. Observe the necessary precautions for handling moisture-sensitive devices as stated in the following section.
2. Recommended board reflow direction:

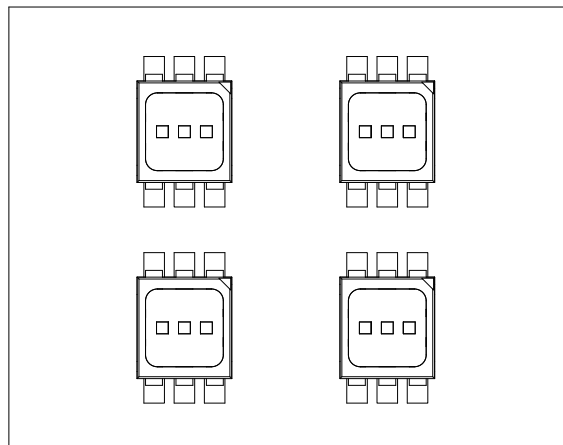

3. Do not apply any pressure or force on the LED during reflow and after reflow when the LED is still hot.
4. Use reflow soldering to solder the LED. Use hand soldering for rework if this is unavoidable, but it must be strictly controlled to the following conditions:
  - Soldering iron tip temperature = 320°C maximum.
  - Soldering duration = 3 seconds maximum.
  - Number of cycles = 1 only.
  - Power of soldering iron = 50W maximum.
5. Do not touch the LED body with hot soldering iron except the soldering terminals because it can cause damage to the LED.
6. For de-soldering, use a double flat tip.
7. Confirm beforehand whether hand soldering will affect the functionality and performance of the LED.

## Precautionary Notes

### Handling Precautions

The encapsulation material of the LED is made of silicone for better product reliability. Compared to epoxy encapsulant, which is hard and brittle, silicone is softer and flexible. Observe special handling precautions during assembly of silicone encapsulated LED products. Failure to comply might lead to damage and premature failure of the LED. Refer to Application Note AN5288, *Silicone Encapsulation for LED: Advantages and Handling Precautions*, for more information.

- Do not poke sharp objects into the silicone encapsulant. Sharp objects, such as tweezers or syringes, might apply excessive force or even pierce through the silicone and induce failures to the LED die or wire bond.
- Do not touch the silicone encapsulant. Uncontrolled force acting on the silicone encapsulant might result in excessive stress on the wire bond. Hold the LED only by the body.
- Do not stack assembled PCBs together. Use an appropriate rack to hold the PCBs.
- The surface of silicone material attracts dust and dirt easier than epoxy due to its surface tackiness. To remove foreign particles on the surface of silicone, use a cotton bud with isopropyl alcohol (IPA). During cleaning, rub the surface gently without putting much pressure on the silicone. Ultrasonic cleaning is not recommended.
- For automated pick-and-place, Broadcom has tested the following nozzle size to work fine with this LED. However, due to the possibility of variations in other parameters, such as pick-and-place machine maker/model and other settings of the machine, verify the nozzle selected will not cause damage to the LED.

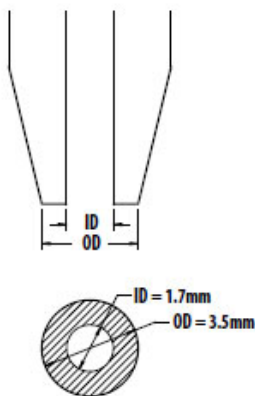

### Handling of Moisture-Sensitive Devices

This product has a Moisture Sensitive Level 2a rating per JEDEC J-STD-020. Refer to Broadcom Application Note AN5305, *Handling of Moisture Sensitive Surface Mount Devices*, for additional details and a review of proper handling procedures.

#### Before use:

- An unopened moisture barrier bag (MBB) can be stored at  $< 40^{\circ}\text{C}/90\% \text{ RH}$  for 12 months. If the actual shelf life has exceeded 12 months and the humidity indicator card (HIC) indicates that baking is not required, it is safe to reflow the LEDs per the original MSL rating.
- Do not open the MBB prior to assembly (for example, for IQC).

#### Control after opening the MBB:

- Read the HIC immediately upon opening the MBB.
- Keep the LEDs at  $< 30^{\circ}\text{C}/60\% \text{ RH}$  at all times and all high-temperature-related processes, including soldering, curing, or rework, must be completed within 672 hours.

#### Control for unfinished reel:

Store unused LEDs in a sealed MBB with desiccant or desiccator at  $< 5\% \text{ RH}$ .

#### Control of assembled boards:

If the PCB soldered with the LEDs is to be subjected to other high-temperature processes, store the PCB in a sealed MBB with desiccant or desiccator at  $< 5\% \text{ RH}$  to ensure that all LEDs have not exceeded their floor life of 168 hours.

#### Baking is required if the following conditions exist:

- The HIC is not BROWN at 10% and is AZURE at 5%.
- The LEDs are exposed to condition of  $> 30^{\circ}\text{C}/60\% \text{ RH}$  at any time.
- The LED floor life exceeded 672 hours.

The recommended baking condition is:  $60^{\circ}\text{C} \pm 5^{\circ}\text{C}$  for 20 hours.

Baking should only be done once.

## Storage:

The soldering terminals of these Broadcom LEDs are silver plated. If the LEDs are exposed in an ambient environment for too long, the silver plating might be oxidized and thus affecting its solderability performance. As such, keep unused LEDs in a sealed MBB with desiccant or in desiccator at < 5% RH.

## Application Precautions

- The drive current of the LED must not exceed the maximum allowable limit across temperature as stated in the data sheet. Constant current driving is recommended to ensure consistent performance.
- LEDs exhibit slightly different characteristics at different drive current, which might result in larger variations in their performance (such as intensity, wavelength, and forward voltage). Set the application current as close as possible to the test current to minimize these variations.
- The LED is not intended for reverse bias. Use other appropriate components for such purposes. When driving the LED in matrix form, ensure that the reverse bias voltage does not exceed the allowable limit of the LED.
- Do not use the LED in the vicinity of material with sulfur content, in an environment of high gaseous sulfur compounds and corrosive elements. Examples of materials that might contain sulfur are rubber gaskets, RTV (room temperature vulcanizing) silicone rubber, rubber gloves, and so on. Prolonged exposure to such environments can affect the optical characteristics and product life.
- Avoid rapid changes in ambient temperature, especially in high-humidity environments, because this will cause condensation on the LED.
- Although the LED is rated as IPx6 according to IEC60529: degree of protection provided by enclosure, the test condition might not represent actual exposure during application. If the LED is to be used in an outdoor or a harsh environment, protect the LED against damages caused by rain water, dust, oil, corrosive gases, external mechanical stress, and so on.

## Thermal Management

Optical, electrical, and reliability characteristics of LED are affected by temperature. The junction temperature ( $T_J$ ) of the LED must be kept below allowable limit at all times.  $T_J$  can be calculated as below:

$$T_J = T_A + R_{\theta J-A} \times I_F \times V_{Fmax}$$

where:

$T_A$  = Ambient temperature (°C)

$R_{\theta J-A}$  = Thermal resistance from LED junction to ambient (°C/W)

$I_F$  = Forward current (A)

$V_{Fmax}$  = Maximum forward voltage (V)

The complication of using this formula lies in  $T_A$  and  $R_{\theta J-A}$ . Actual  $T_A$  is sometimes subjective and hard to determine.  $R_{\theta J-A}$  varies from system to system depending on design and is usually not known.

Another way of calculating  $T_J$  is by using solder point temperature  $T_S$  as shown below:

$$T_J = T_S + R_{\theta J-S} \times I_F \times V_{Fmax}$$

where;

$T_S$  = LED solder point temperature as shown in illustration below (°C)

$R_{\theta J-S}$  = thermal resistance from junction to solder point (°C/W)

$T_S$  can be measured easily by mounting a thermocouple on the soldering joint as shown in illustration above, while  $R_{\theta J-S}$  is provided in the data sheet. Verify the  $T_S$  of the LED in the final product to ensure that the LEDs are operated within all maximum ratings stated in the data sheet.

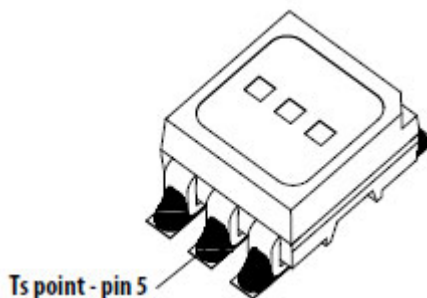

## Eye Safety Precautions

LEDs can pose optical hazards when in operation. Do not view directly at operating LEDs because it can be harmful to the eyes. For safety reasons, use appropriate shielding or personal protective equipment.

## Disclaimer

Broadcom's products are not specifically designed, manufactured, or authorized for sale as parts, components, or assemblies for the planning, construction, maintenance, or direct operation of a nuclear facility or for use in medical devices or applications. The customer is solely responsible, and waives all rights to make claims against Broadcom or its suppliers, for all loss, damage, expense, or liability in connection with such use.

Broadcom, the pulse logo, Connecting everything, Avago Technologies, Avago, and the A logo are among the trademarks of Broadcom and/or its affiliates in the United States, certain other countries, and/or the EU.

Copyright © 2014–2021 Broadcom. All Rights Reserved.

The term "Broadcom" refers to Broadcom Limited and/or its subsidiaries. For more information, please visit [www.broadcom.com](http://www.broadcom.com).

Broadcom reserves the right to make changes without further notice to any products or data herein to improve reliability, function, or design. Information furnished by Broadcom is believed to be accurate and reliable. However, Broadcom does not assume any liability arising out of the application or use of this information, nor the application or use of any product or circuit described herein, neither does it convey any license under its patent rights nor the rights of others.

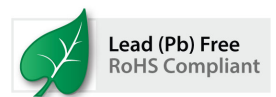

## X-ON Electronics

Largest Supplier of Electrical and Electronic Components

*Click to view similar products for [Standard LEDs - SMD category](#):*

*Click to view products by [Broadcom manufacturer](#):*

Other Similar products are found below :

[LTST-C19GD2WT](#) [LTST-N683GBEW](#) [LTW-170ZDC](#) [LTW-M140SZS40](#) [598-8110-100F](#) [598-8170-100F](#) [598-8610-202F](#) [67-22VRVGC/TR8](#) [AAAF5060QBFSEEZGS](#) [HLMA-QG00-S0021](#) [HLMP-6305-L0011](#) [ALMD-LB36-SV002](#) [APT1608QGW](#) [15-21UYC/S530-A3/TR8](#) [EASV1803BA0](#) [LG M67K-H1J2-24-0-2-R18-Z](#) [LS A676-P2S1-1](#) [SML-512VWT86A](#) [SML-LX0606SISUGC/A](#) [SML-LXL1307SRC-TR](#) [SML-LXR851SIUPGUBC](#) [LT1ED53A](#) [FAT801-S](#) [AM27ZGC03](#) [APB3025SGNC](#) [APFA3010SURKCGKQBDC](#) [APHK1608VGCA](#) [APT2012QGW](#) [CLX6D-FKB-CN1R1H1BB7D3D3](#) [LTST-C250KGKT](#) [LTW-020ZDCG](#) [LTW-21TS5](#) [LTW-220DS5](#) [JANTXM19500/521-02](#) [UYGT801-S](#) [42-21UYC/S530-A3/TR8](#) [LO T67F-V1AB-24-1](#) [YGFR411-H](#) [SML-LX0402IC-TR](#) [CMDA20AYAA7D1S](#) [CMDA16AYDR7A1X](#) [339-1SURSYGW/S530-A2](#) [598-8040-100F](#) [598-8070-100F](#) [598-8140-100F](#) [598-8610-200F](#) [EAPL3527GA5](#) [SML-LXL1209SYC/ATR](#) [EASV3020YGA0](#) [EAST16086YA5](#)