

## ASMT-YTD2-0BB02

### High Brightness Tricolor PLCC-6 White Surface LED



#### Description

This family of Broadcom<sup>®</sup> SMT LEDs is packaged in the form of PLCC-6 with a separate heat path for each LED die, enabling it to be driven at higher current.

Individually addressable pin-outs give higher flexibility in circuitry design. With closely matched radiation pattern along the package's X-axis, these LEDs are suitable for indoor full color display application.

For easy pick and place, the LEDs are shipped in tape and reel. Every reel is shipped from a single intensity and color bin for better uniformity.

These LEDs are compatible with reflow soldering process.

**CAUTION!** LEDs are Class 1C ESD sensitive. Observe appropriate precautions during handling and processing. Refer to Broadcom Application Note AN-1142 for additional details.

#### Features

- Standard PLCC-6 package (Plastic Leaded Chip Carrier) with individual addressable pin-out for higher flexibility of driving configuration
  - High-reliability LED package with silicone encapsulation
  - High brightness using AlInGaP and InGaN dice technologies
  - Typical viewing angle is 120°
  - Compatible with reflow soldering process
  - JEDEC MSL 2a
  - Water-Resistance (IPX6\*) per IEC 60529:2001
- \* The test is conducted on component level by mounting the components on PCB with proper potting to protect the leads. It is strongly recommended that customers perform necessary tests on the components for their final application.

#### Applications

- Full color sign display
- Gaming machine

## Package Dimensions

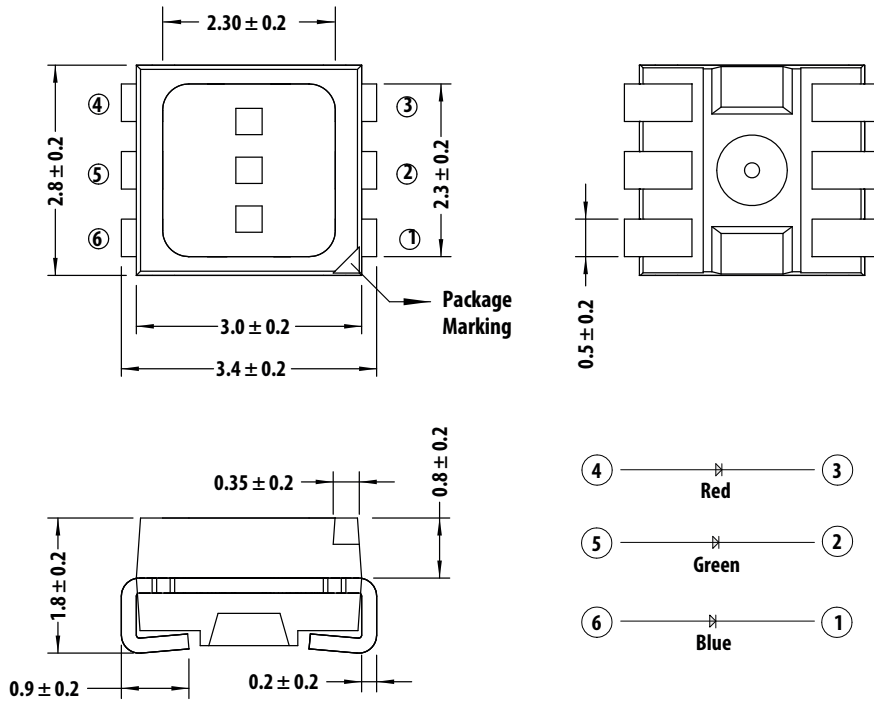

## Lead Configuration

1	Cathode (Blue)
2	Cathode (Green)
3	Cathode (Red)
4	Anode (Red)
5	Anode (Green)
6	Anode (Blue)

### NOTE:

1. All dimensions are in millimeters (mm).
2. Unless otherwise specified, tolerance is  $\pm 0.20$  mm.
3. Encapsulation = silicone.
4. Terminal finish = silver plating.

**Table 1. Absolute Maximum Ratings ( $T_J = 25^\circ\text{C}$ )**

Parameter	Red	Green and Blue	Units
DC forward current <sup>a</sup>	50	30	mA
Peak forward current <sup>b</sup>	100	100	mA
Power dissipation	125	114	mW
Reverse voltage <sup>c</sup>	4		V
Junction temperature	125		$^\circ\text{C}$
Operating temperature range	-40 to + 110		$^\circ\text{C}$
Storage temperature range	-40 to +120		$^\circ\text{C}$

- Derate linearly as shown in [Figure 7](#) to [Figure 10](#).
- Duty Factor = 10%, frequency = 1 kHz.
- Driving the LED in reverse bias condition is suitable for the short term only.

**Table 2. Optical Characteristics ( $T_J = 25^\circ\text{C}$ )**

Color	Luminous Intensity, $I_V$ (mcd) at $I_F = 20\text{ mA}^a$			Dominant Wavelength, $\lambda_d$ (nm) at $I_F = 20\text{ mA}^b$			Peak Wavelength, $\lambda_P$ (nm) at $I_F = 20\text{ mA}$	Viewing Angle, $2\theta_{1/2}$ ( $^\circ$ ) <sup>c</sup>	Luminous Efficacy, $\eta_V$ (lm/W) <sup>d</sup>	Luminous Efficiency, $\eta_e$ (lm/W)
	Min.	Typ.	Max.	Min.	Typ.	Max.	Typ.	Typ.	Typ.	Typ.
Red	560	745	1125	618	622	628	629	120	210	43
Green	1800	2280	3550	525	530	537	521	120	535	75
Blue	355	520	715	465	470	477	464	120	84	15

- The luminous intensity  $I_V$  is measured at the mechanical axis of the LED package at a single current pulse condition. The actual peak of the spatial radiation pattern may not be aligned with the axis.
- The dominant wavelength is derived from the CIE Chromaticity Diagram and represents the perceived color of the device.
- $\theta_{1/2}$  is the off-axis angle where the luminous intensity is  $1/2$  the peak intensity.
- $\Phi_V$  is the total luminous flux output as measured with an integrating sphere at mono pulse condition.

**Table 3. Electrical Characteristics ( $T_J = 25^\circ\text{C}$ )**

Color	Forward Voltage, $V_F$ (V) at $I_F = 20\text{ mA}^a$			Reverse Voltage, $V_R$ at $I_R = 100\ \mu\text{A}^b$	Reverse Voltage, $V_R$ at $I_R = 10\ \mu\text{A}^b$	Thermal Resistance, $R_{\theta_{J-S}}$ ( $^\circ\text{C}/\text{W}$ )	
	Min.	Typ.	Max.	Min.	Min.	1 Chip On	3 Chips On
Red	1.8	2.0	2.5	4.0	—	280	280
Green	2.4	2.9	3.4	—	4.0	180	230
Blue	2.4	2.9	3.4	—	4.0	180	230

- Tolerance =  $\pm 0.1\text{V}$ .
- Indicates product final testing condition. Long-term reverse bias is not recommended.

## Part Numbering System

A S M T - Y T D 2 - 0 B B 0 2

X<sub>1</sub>

X<sub>2</sub>
X<sub>3</sub>
X<sub>4</sub>
X<sub>5</sub>

Code	Description	Option				
x <sub>1</sub>	Package type	D	White surface			
x <sub>2</sub>	Minimum intensity bin	B	Red:	Bin U2	Red	Bin U2, V1, V2
			Green:	Bin X1	Green	Bin X1, X2, Y1
			Blue:	Bin T2	Blue	Bin T2, U1, U2
x <sub>3</sub>	Number of intensity bins	B	Three intensity bins from minimum			
x <sub>4</sub>	Color bin combination	0	Red:	Full distribution		
			Green:	Bin A, B, C		
			Blue:	Bin A, B, C, D, E		
x <sub>5</sub>	Test option	2	Test current = 20 mA			

## Table 4. Bin Information

### Intensity Bins (CAT)

Bin ID	Luminous intensity (mcd)	
	Min.	Max.
T1	285	355
T2	355	450
U1	450	560
U2	560	715
V1	715	900
V2	900	1125
W1	1125	1400
W2	1400	1800
X1	1800	2240
X2	2240	2850
Y1	2850	3550

Tolerance:  $\pm 12\%$ 

### Color Bins (BIN) – Green

Bin ID	Dominant Wavelength (nm)		Chromaticity Coordinate (for Reference)	
	Min.	Max.	Cx	Cy
A	525.0	531.0	0.1142	0.8262
			0.1799	0.6783
			0.2138	0.6609
			0.1625	0.8012
B	528.0	534.0	0.1387	0.8148
			0.1971	0.6703
			0.2298	0.6507
			0.1854	0.7867
C	531.0	537.0	0.1625	0.8012
			0.2138	0.6609
			0.2454	0.6397
			0.2077	0.7711

Tolerance:  $\pm 1$  nm.

### Color Bins (BIN) – Red

Bin ID	Dominant Wavelength (nm)		Chromaticity Coordinate (for Reference)	
	Min.	Max.	Cx	Cy
—	618.0	628.0	0.6873	0.3126
			0.6696	0.3136
			0.6866	0.2967
			0.7052	0.2948

Tolerance:  $\pm 1$  nm.

### Color Bins (BIN) – Blue

Bin ID	Dominant Wavelength (nm)		Chromaticity Coordinate (for Reference)	
	Min.	Max.	Cx	Cy
A	465.0	469.0	0.1355	0.0399
			0.1751	0.0986
			0.1680	0.1094
			0.1267	0.0534
B	467.0	471.0	0.1314	0.0459
			0.1718	0.1034
			0.1638	0.1167
			0.1215	0.0626
C	469.0	473.0	0.1267	0.0534
			0.1680	0.1094
			0.1593	0.1255
D	471.0	475.0	0.1158	0.0736
			0.1215	0.0626
			0.1638	0.1167
E	473.0	477.0	0.1543	0.1361
			0.1096	0.0868
			0.1158	0.0736
			0.1593	0.1255
			0.1489	0.1490
			0.1028	0.1029

Tolerance:  $\pm 1$  nm.

# Characteristics

Figure 1: Relative Spectral Emission

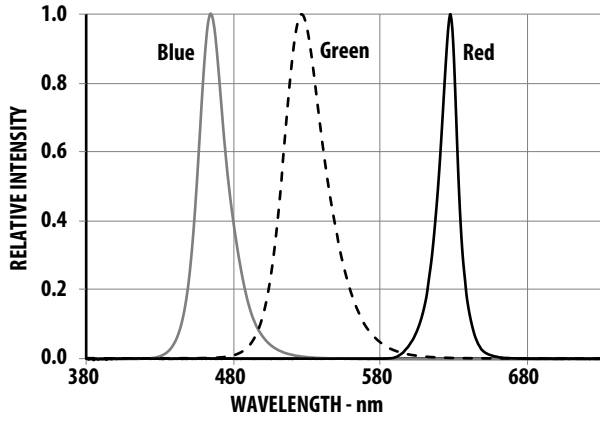

Figure 2: Forward Current vs. Forward Voltage

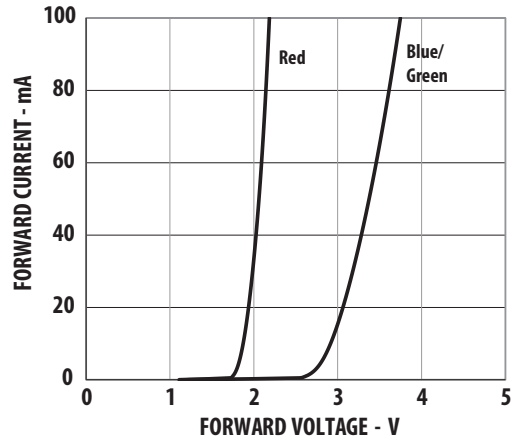

Figure 3: Relative Luminous Intensity vs. Forward Current

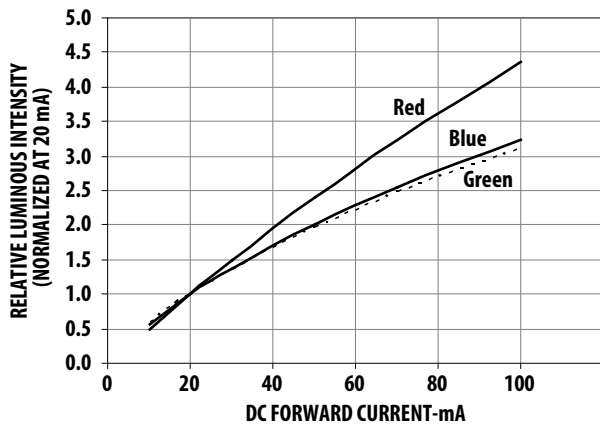

Figure 4: Dominant Wavelength Shift vs. Forward Current

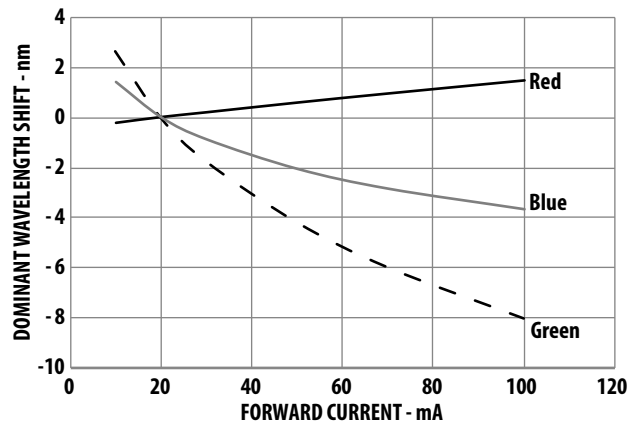

Figure 5: Relative Luminous Intensity vs. Junction Temperature

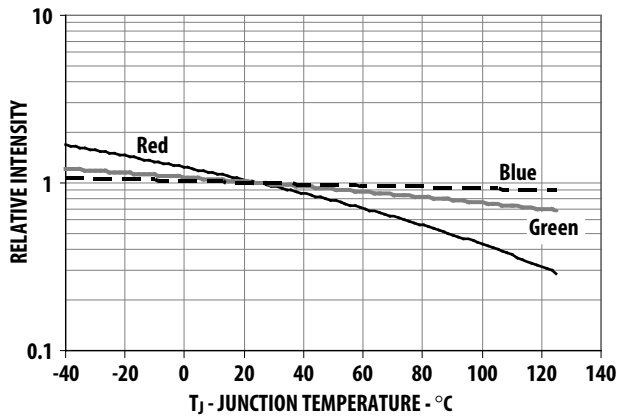

Figure 6: Forward Voltage Shift vs. Junction Temperature

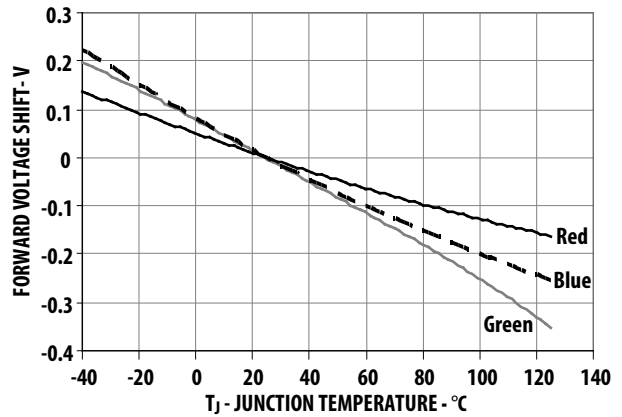

Figure 7: Maximum Forward Current vs. Temperature for Red (1 Chip On)

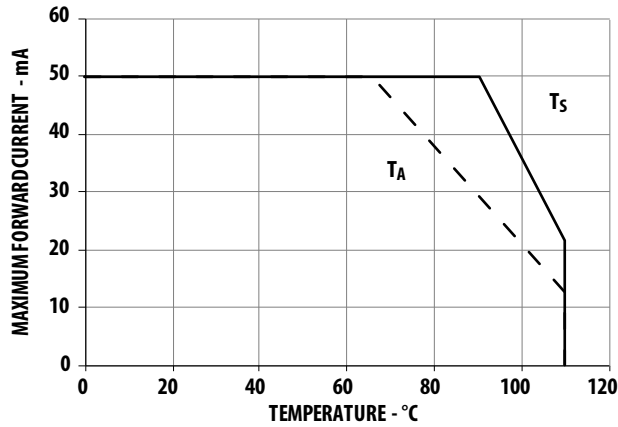

Figure 8: Maximum Forward Current vs. Temperature for Red (3 Chips On)

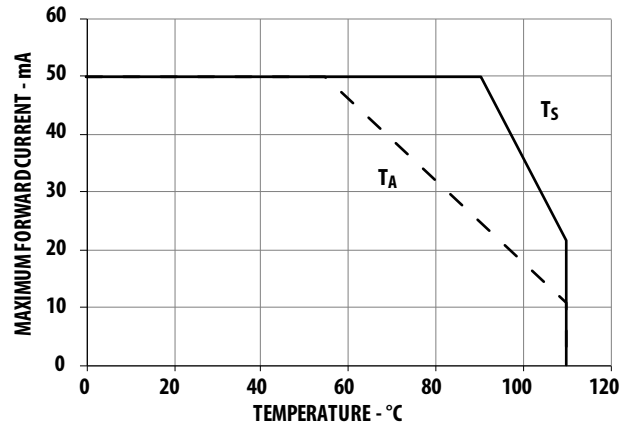

Figure 9: Maximum Forward Current vs. Temperature for Green and Blue (1 Chip On)

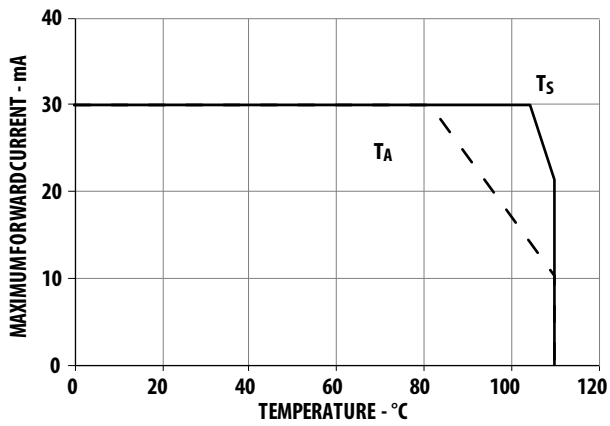
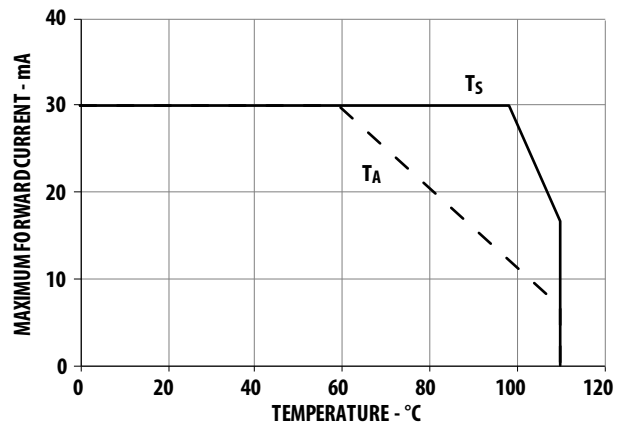

Figure 10: Maximum Forward Current vs. Temperature for Green and Blue (3 Chips On)



**NOTE:** Maximum forward current graphs based on ambient temperature,  $T_A$  are with reference to thermal resistance  $R_{\theta_{J-A}}$  as follows. For more details, see [Thermal Management](#).

Condition	Thermal Resistance from LED Junction to Ambient, $R_{\theta_{J-A}}$ ( $^{\circ}\text{C}/\text{W}$ )	
	Red	Green and Blue
1 chip on	473	373
3 chips on	563	563

Figure 11: Radiation Pattern Along X-Axis of the Package

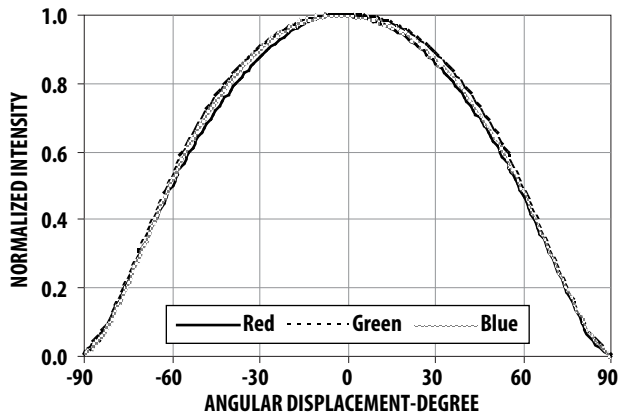

Figure 12: Radiation Pattern Along Y-Axis of the Package

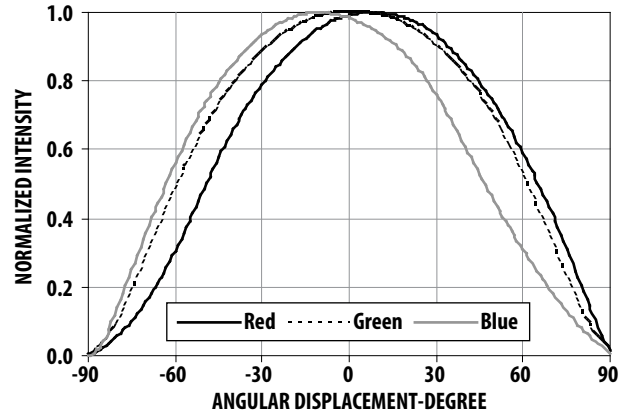

Figure 13: Illustration of Package Axis for Radiation Pattern

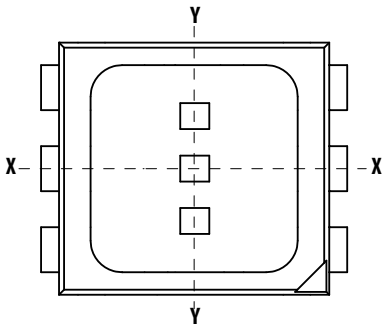



Figure 14: Recommended Soldering Land Pattern

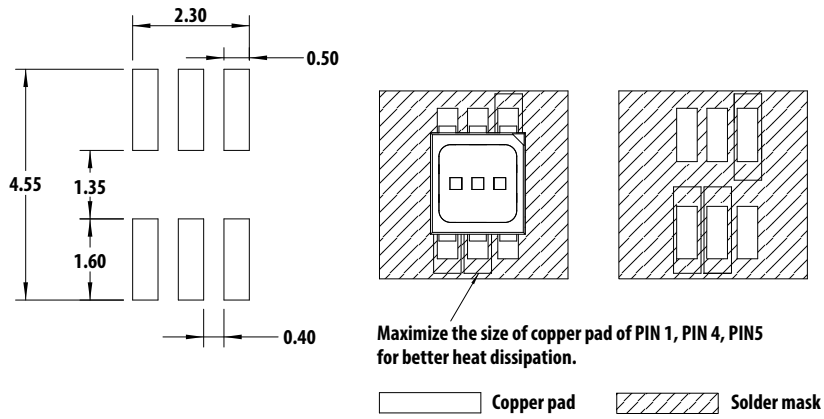

Figure 15: Carrier Tape Dimensions

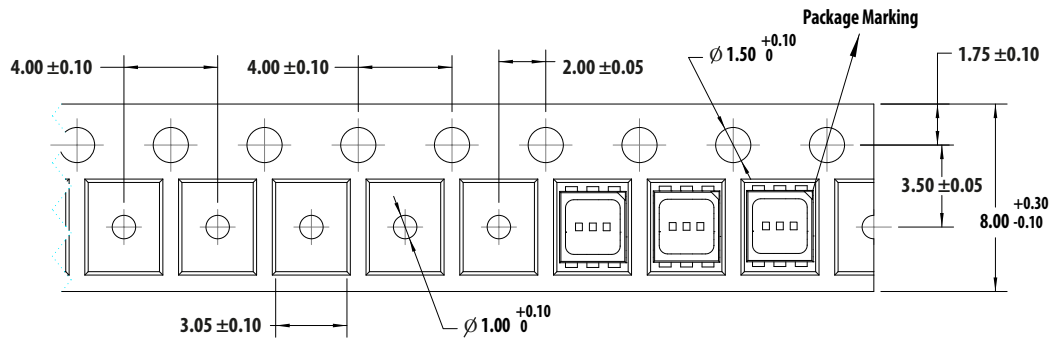

Figure 16: Reeling Orientation

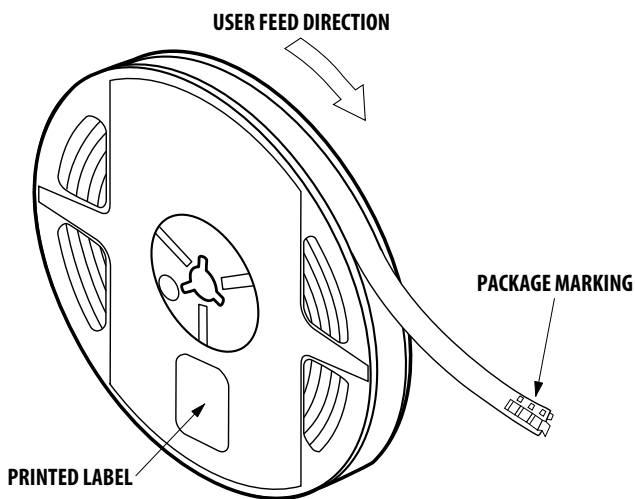
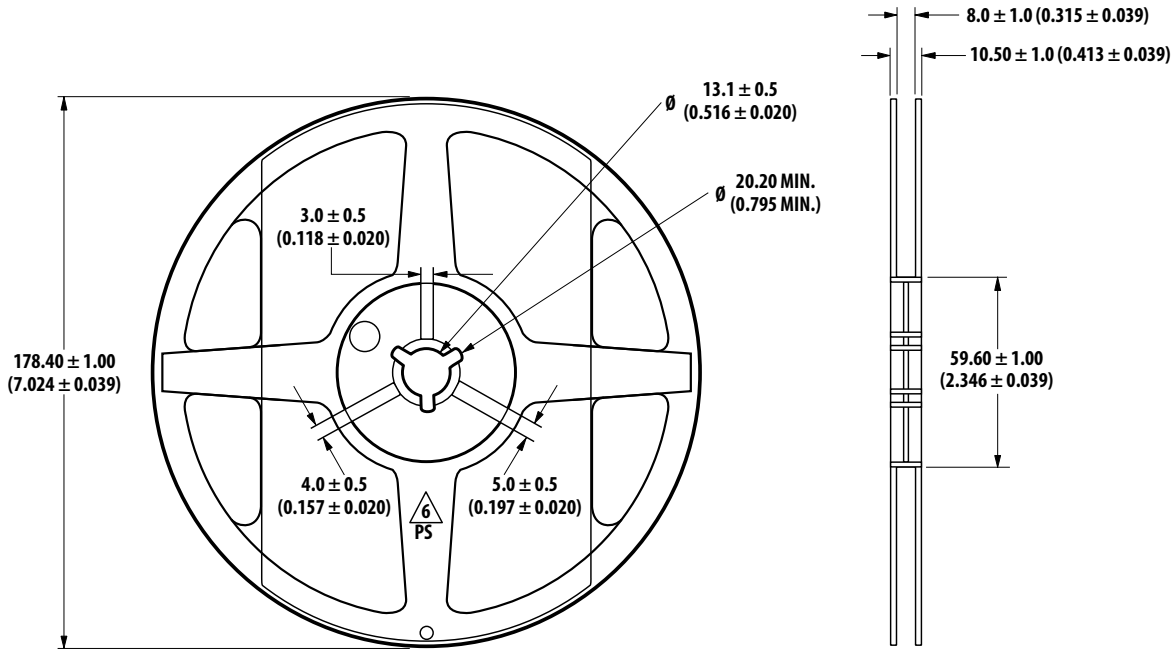

Figure 17: Reel Dimensions







# Packing Label

(i) Standard label (attached on moisture barrier bag)

<p>(1P) Item: <b>Part Number</b>  </p>		<p><b>AvAGO</b>                  TECHNOLOGIES                  STANDARD LABEL LS0002                  RoHS Compliant Halogen Free                  e4 Max Temp 260C MSL2a</p>	
<p>(1T) Lot: <b>Lot Number</b>  </p>		<p>(Q) QTY: <b>Quantity</b>  </p>	
<p>LPN:  </p>		<p>CAT: <b>Intensity Bin</b>  </p>	
<p>(9D)MFG Date: <b>Manufacturing Date</b>  </p>		<p>BIN: <b>Color Bin</b>  </p>	
<p>(P) Customer Item:  </p>			
<p>(V) Vendor ID:  </p>		<p>(9D) Date Code: <b>Date Code</b>  </p>	
<p>DeptID:  </p>		<p>Made In: <b>Country of Origin</b>  </p>	

(ii) Baby label (attached on plastic reel)

<p>(1P) PART #: <b>Part Number</b>  </p>		<p><b>AvAGO</b>                  TECHNOLOGIES                  BABY LABEL COSB001B V0.0</p>	
<p>(1T) LOT #: <b>Lot Number</b>  </p>			
<p>(9D)MFG DATE: <b>Manufacturing Date</b>  </p>		<p>QUANTITY: <b>Packing Quantity</b>  </p>	
<p>C/O: <b>Country of Origin</b></p>		<p>(9D): DATE CODE:</p>	
<p>(1T) TAPE DATE:  </p>		<p>D/C: <b>Date Code</b> VF:</p>	
		<p>CAT: <b>INTENSITY BIN</b></p>	
		<p>BIN: <b>COLOR BIN</b></p>	

Example of luminous intensity (lv) bin information on label:

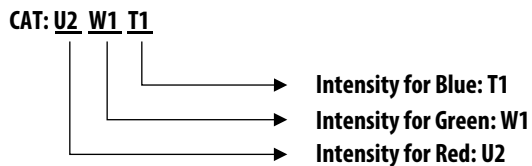

Example of color bin information on label:

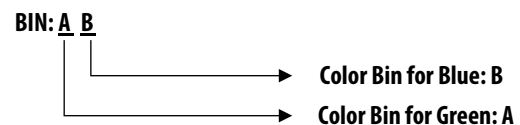

**NOTE:** There is no color bin ID for Red color as there is only one range, as stated in Table 4.

# Soldering

## Recommended Reflow Soldering Conditions

### (i) Leaded Reflow Soldering

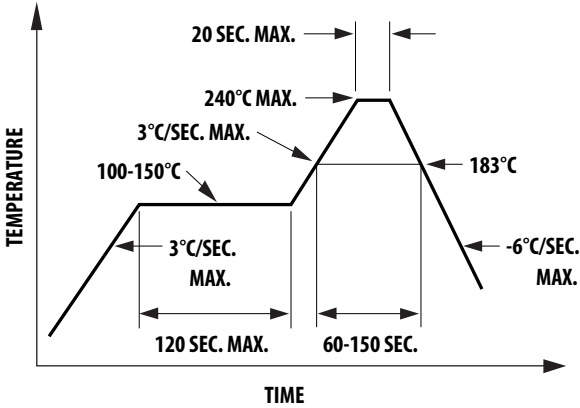

### (ii) Lead-Free Reflow Soldering

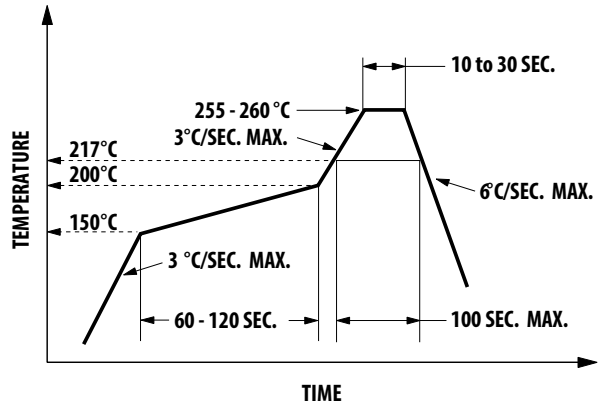

1. Reflow soldering must not be done more than twice. Observe necessary precautions for handling moisture-sensitive devices as stated in [Handling of Moisture Sensitive Devices](#).
2. The recommended board reflow direction is shown in the following figure.

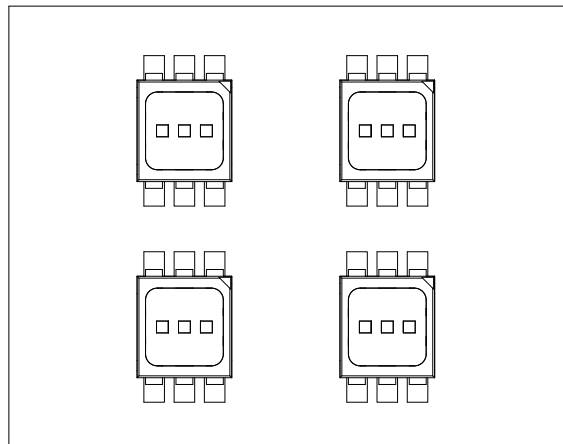

3. Do not apply any pressure or force on the LED during reflow and after reflow when the LED is still hot.
4. Use reflow soldering to solder the LED. Use hand soldering for rework if this is unavoidable, but it must be strictly controlled to the following conditions:
  - Soldering iron tip temperature = 320°C maximum
  - Soldering duration = 3 seconds maximum
  - Number of cycles = 1 only
  - Power of soldering iron = 50W maximum
5. Do not touch the LED body with a hot soldering iron except the soldering terminals as it may cause damage to the LED.
6. For de-soldering, use a double flat tip.
7. Confirm beforehand whether hand soldering will affect the functionality and performance of the LED.

## Precautionary Notes

### Handling Precautions

The encapsulation material of the LED is made of silicone for better product reliability. Compared to epoxy encapsulant that is hard and brittle, silicone is softer and flexible. Observe special handling precautions during the assembly of silicone encapsulated LED products. Failure to comply might lead to damage and premature failure of the LED. Refer to Application Note AN5288, *Silicone Encapsulation for LED: Advantages and Handling Precautions* for more information.

- Do not poke sharp objects into the silicone encapsulant. Sharp objects, such as tweezers or syringes, might apply excessive force or even pierce through the silicone and induce failures to the LED die or wire bond.
- Do not touch the silicone encapsulant. Uncontrolled force acting on the silicone encapsulant might result in excessive stress on the wire bond. Hold the LED only by the body.
- Do not stack assembled PCBs together. Use an appropriate rack to hold the PCBs.
- Surface of silicone material attracts dust and dirt easier than epoxy due to its surface tackiness. To remove foreign particles on the surface of silicone, use a cotton bud with isopropyl alcohol (IPA). During cleaning, rub the surface gently without putting much pressure on the silicone. Ultrasonic cleaning is not recommended.
- For automated pick and place, Broadcom has tested the following nozzle size to be work well with this LED. However, due to the possibility of variations in other parameters, such as pick and place machine maker/model and other settings of the machine, verify that the nozzle selected will not cause damage to the LED.

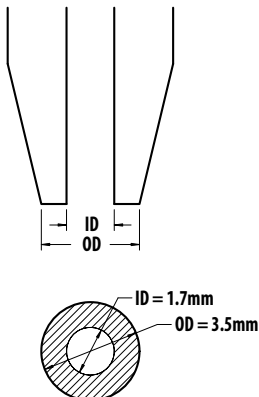

### Handling of Moisture Sensitive Devices

This product has a Moisture Sensitive Level 2a rating per JEDEC J-STD-020. Refer to Broadcom Application Note AN5305, *Handling of Moisture Sensitive Surface Mount Devices*, for additional details and a review of proper handling procedures.

#### Before use:

- An unopened moisture barrier bag (MBB) can be stored at  $< 40^{\circ}\text{C}/90\% \text{RH}$  for 12 months. If the actual shelf life has exceeded 12 months and the humidity indicator card (HIC) indicates that baking is not required, then it is safe to reflow the LEDs per the original MSL rating.
- Do not open the MBB prior to assembly (for example, for IQC).

#### Control after opening the MBB:

- Read the HIC immediately upon opening of the MBB.
- Keep the LEDs at  $< 30^{\circ}\text{C}/60\% \text{RH}$  at all times and all high temperature-related processes, including soldering, curing, or rework, need to be completed within 672 hours.

#### Control for unfinished reel:

Store unused LEDs in a sealed MBB with desiccant or desiccator at  $< 5\% \text{RH}$ .

#### Control of assembled boards:

If the PCB soldered with the LEDs is to be subjected to other high-temperature processes, store the PCB in a sealed MBB with desiccant or desiccator at  $< 5\% \text{RH}$  to ensure that all LEDs have not exceeded their floor life of 672 hours.

#### Baking is required if the following conditions exist:

- The HIC indicator indicates a change in color for 10% and 5%, as stated on the HIC.
- The LEDs are exposed to a condition of  $> 30^{\circ}\text{C}/60\% \text{RH}$  at any time.
- The LED floor life exceeded 672 hours.

The recommended baking condition is:  $60^{\circ}\text{C} \pm 5^{\circ}\text{C}$  for 20 hours.

Baking should only be done once.

## Storage:

The soldering terminals of these Broadcom LEDs are silver-plated. If the LEDs are exposed in an ambient environment for too long, the silver plating might be oxidized and thus affect its solderability performance. As such, keep unused LEDs in a sealed MBB with desiccant or in desiccator at <5 % RH.

## Application Precautions

- The drive current of the LED must not exceed the maximum allowable limit across temperature as stated in the data sheet. Constant current driving is recommended to ensure consistent performance.
- LEDs exhibit slightly different characteristics at different drive currents that might result in larger variation their performance (that is, intensity, wavelength, and forward voltage). Set the application current as close as possible to the test current in order to minimize these variations.
- The LED is not intended for reverse bias. Use other appropriate components for such purposes. When driving the LED in matrix form, ensure that the reverse bias voltage does not exceed the allowable limit of the LED.
- Do not use the LED in the vicinity of material with sulfur content, in an environment of high gaseous sulfur compound and corrosive elements. Examples of material that may contain sulfur are rubber gasket, RTV (room temperature vulcanizing) silicone rubber, rubber gloves, and so on. Prolonged exposure to such environments may affect the optical characteristics and product life.
- Avoid rapid change in ambient temperature especially in high-humidity environments as this will cause condensation on the LED.
- Although the LED is rated as IPx6 according to IEC60529: Degree of protection provided by enclosure, the test condition may not represent actual exposure during application. If the LED is intended to be used in an outdoor or a harsh environment, protect the LED against damages caused by rain water, dust, oil, corrosive gases, external mechanical stress, and so on.

## Thermal Management

Optical, electrical, and reliability characteristics of the LED are affected by temperature. The junction temperature ( $T_J$ ) of the LED must be kept below allowable limit at all times.  $T_J$  can be calculated as follows:

$$T_J = T_A + R_{\theta J-A} \times I_F \times V_{Fmax}$$

where:

$T_A$  = Ambient temperature (°C)

$R_{\theta J-A}$  = Thermal resistance from LED junction to ambient (°C/W)

$I_F$  = Forward current (A)

$V_{Fmax}$  = Maximum forward voltage (V)

The complication of using this formula lies in  $T_A$  and  $R_{\theta J-A}$ . Actual  $T_A$  is sometimes subjective and hard to determine.  $R_{\theta J-A}$  varies from system to system depending on design and is usually not known.

Another way of calculating  $T_J$  is by using solder point temperature  $T_S$  as shown below:

$$T_J = T_S + R_{\theta J-S} \times I_F \times V_{Fmax}$$

where:

$T_S$  = LED solder point temperature as shown in the following illustration (°C)

$R_{\theta J-S}$  = Thermal resistance from junction to solder point (°C/W)

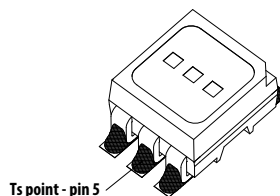

$T_S$  can be measured easily by mounting a thermocouple on the soldering joint as shown in preceding illustration, while  $R_{\theta J-S}$  is provided in the data sheet. The user is advised to verify the  $T_S$  of the LED in the final product to ensure that the LEDs are operated within all maximum ratings stated in the data sheet.

## Eye Safety Precautions

LEDs may pose optical hazards when in operation. Do not look directly at operating LEDs as it may be harmful to the eyes. For safety reasons, use appropriate shielding or personal protective equipment.

## Disclaimer

Broadcom's products are not specifically designed, manufactured, or authorized for sale as parts, components or assemblies for the planning, construction, maintenance, or direct operation of a nuclear facility or for use in medical devices or applications. The customer is solely responsible, and waives all rights to make claims against Broadcom or its suppliers, for all loss, damage, expense, or liability in connection with such use.

Broadcom, the pulse logo, Connecting everything, Avago Technologies, Avago, and the A logo are among the trademarks of Broadcom and/or its affiliates in the United States, certain other countries, and/or the EU.

Copyright © 2015–2021 Broadcom. All Rights Reserved.

The term "Broadcom" refers to Broadcom Inc. and/or its subsidiaries. For more information, please visit [www.broadcom.com](http://www.broadcom.com).

Broadcom reserves the right to make changes without further notice to any products or data herein to improve reliability, function, or design. Information furnished by Broadcom is believed to be accurate and reliable. However, Broadcom does not assume any liability arising out of the application or use of this information, nor the application or use of any product or circuit described herein, neither does it convey any license under its patent rights nor the rights of others.

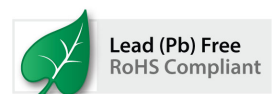

## X-ON Electronics

Largest Supplier of Electrical and Electronic Components

*Click to view similar products for [Standard LEDs - SMD category](#):*

*Click to view products by [Broadcom manufacturer](#):*

Other Similar products are found below :

[LTST-C19GD2WT](#) [LTST-N683GBEW](#) [LTW-170ZDC](#) [LTW-M140SZS40](#) [598-8110-100F](#) [598-8170-100F](#) [598-8610-202F](#) [67-22VRVGC/TR8](#) [AAAF5060QBFSEEZGS](#) [HLMP-6305-L0011](#) [ALMD-LB36-SV002](#) [APT1608QGW](#) [15-21UYC/S530-A3/TR8](#) [EASV1803BA0](#) [LS A676-P2S1-1](#) [SML310BATT86](#) [SML-512VWT86A](#) [SML-LX0606SISUGC/A](#) [SML-LXL1307SRC-TR](#) [SML-LXR851SIUPGUBC](#) [LT1ED53A](#) [FAT801-S](#) [AM27ZGC03](#) [APB3025SGNC](#) [APFA3010SURKCGKQBDC](#) [APHK1608VGCA](#) [APT2012QGW](#) [CLX6D-FKB-CN1R1H1BB7D3D3](#) [LTST-C250KGKT](#) [LTW-020ZDCG](#) [LTW-21TS5](#) [LTW-220DS5](#) [JANTXM19500/521-02](#) [UYGT801-S](#) [LO T67F-V1AB-24-1](#) [YGFR411-H](#) [SML-LX0402IC-TR](#) [CMDA20AYAA7D1S](#) [CMDA16AYDR7A1X](#) [339-1SURYGW/S530-A2](#) [598-8040-100F](#) [598-8070-100F](#) [598-8140-100F](#) [598-8610-200F](#) [EAPL3527GA5](#) [67-11/BHC-M1N2B8Y/2A0](#) [SML-LXL1209SYC/ATR](#) [EASV3020YGA0](#) [EAST16086YA5](#) [CMD91-21VRC/TR7](#)