

ASMW-LD00, ASMW-L300, ASMW-LL00

0.5W 2835 Surface Mount LED

Overview

The Broadcom® 2835 Surface Mount LEDs are energy efficient LEDs that can be driven at high driving current and able to dissipate heat efficiently resulting in a better performance in reliability. Its low profile package design addresses a wide variety of applications where superior robustness and high efficiency are required. In addition to being compatible to reflow soldering process, the silicone encapsulation ensures product superiority and longevity.

To facilitate easy pick and place assembly, the LEDs are packed in tape and reel. Every reel is shipped in single flux and color bin, to provide close uniformity.

Features

- High reliability package with enhanced silicone resin encapsulation
- Available in Deep Red, Far Red and Royal Blue
- Wide viewing angle at 120°
- JEDEC MSL 3
- Enhanced corrosion resistance

Applications

- Horticulture lighting
- General lighting
- Commercial lighting
- Architecture lighting

CAUTION!

This LED is ESD sensitive. Please observe appropriate precautions during handling and processing. Refer to application note AN-1142 for additional detail.

Figure 1: Package Drawing

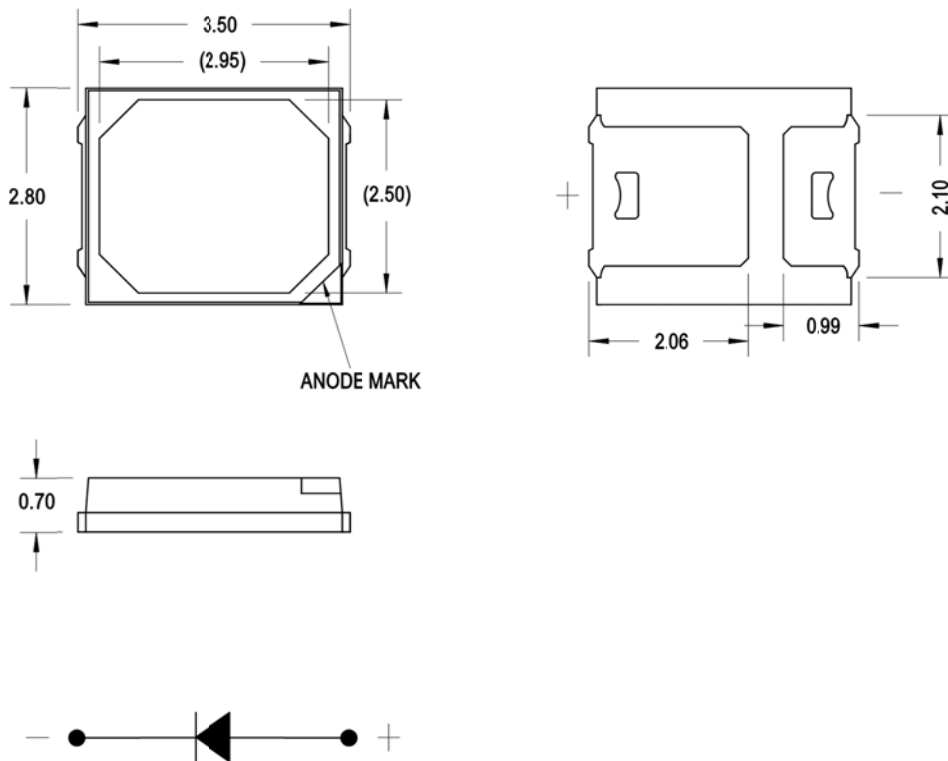

NOTE:

1. All dimensions in millimeters (mm).
2. Tolerance is $\pm 0.20\text{mm}$ unless otherwise specified.
3. Encapsulation = silicone.
4. Terminal finish = silver plating.
5. Dimensions in bracket are for reference only.

Device Selection Guide ($T_J = 25^\circ\text{C}$, $I_F = 150\text{mA}$)

Part Number	Color	Viewing Angle, $2\theta_{1/2}$ ^a	Radiant Flux, Φ_e (mW) ^{b, c}			PPF, Φ_P ($\mu\text{mol/s}$) ^{d, e, f}	Luminous Flux, Φ_v (lm) ^f	Dice Technology
		Typ.	Min.	Typ.	Max.	Typ.	Typ.	
ASMW-LD00-AGJ0E	Deep Red	120	85	115	180	0.61	8.8	AllnGaP
ASMW-L300-AFH0E	Far Red	120	65	95	140	0.58	-	AllnGaP
ASMW-LL00-NKM0E	Royal Blue	120	180	240	330	0.90	8.6	InGaN

- a. $\theta_{1/2}$ is the off-axis angle where the luminous intensity is half of the peak intensity.
- b. Radiant flux, Φ_e / Luminous flux, Φ_v is the total output measured with an integrating sphere at a single current pulse condition.
- c. Radiant flux tolerance is $\pm 12\%$.
- d. Photosynthetic Photon Flux (PPF), Φ_P is the measurement of Photosynthetically Active Radiation (PAR) ranging from 400 – 700nm.
- e. PPF for Far Red is measured from 700 – 800nm.
- f. Values are for reference only.

Absolute Maximum Ratings

Parameters	ASMW-LD00	ASMW-L300	ASMW-LL00	Unit
DC Forward Current ^a	200			mA
Peak Forward Current ^b	300			mA
Power Dissipation	540	500	740	mW
Reverse Voltage	Not designed for reverse bias operation			
LED Junction Temperature	125			°C
Operating Temperature Range	-40 to +100			°C
Storage Temperature Range	-40 to +100			°C

a. Derate linearly as shown in Figure 11 and Figure 12.

b. Duty factor = 10%, frequency = 1KHz.

Optical and Electrical Characteristics (T_J = 25°C, I_F = 150mA)

Color	Dominant Wavelength, λ _d (nm) ^a			Peak Wavelength, λ _p (nm)			Forward Voltage, V _F (V) ^b			Thermal Resistance, R _{θJ-S} (°C/W) ^c	Reverse Current (μA) ^d V _R = 5V
	Min.	Typ.	Max.	Min.	Typ.	Max.	Min.	Typ.	Max.	Typ.	
Deep Red	–	640	–	650	656	670	1.8	2.25	2.7	27	10
Far Red	–	–	–	720	731	740	1.6	2.16	2.5	27	10
Royal Blue	–	456	–	440	451	460	2.9	3.08	3.7	36	10

a. The dominant wavelength, λ_d is derived from the CIE Chromaticity diagram and represents the perceived color of the device.

b. Forward voltage, V_F tolerance is ±0.1V.

c. Thermal resistance from LED junction to solder point.

d. Indicates product final test condition only. Long term reverse bias is not recommended.

Part Numbering System

A S M W - L x₁ 0 0 - x₂ x₃ x₄ x₅ x₆

Code	Description	Option	
x ₁	Color	3	Far Red
		D	Deep Red
		L	Royal Blue
x ₂	Dice Technology	A	AllnGaP
		N	InGaN
x ₃	Minimum Radiant Flux Bin	Refer to Radiant Flux Bin Limits (CAT) table	
x ₄	Maximum Radiant Flux Bin		
x ₅	Color Bin Option	0	Full Distribution
x ₆	Test Option	E	Test Current = 150mA

Part Number Example

ASMW-LD00-AGJ0E

- x₁ : D – Deep Red color
- x₂ : A – AllnGaP dice
- x₃ : G – Minimum Radiant flux bin G
- x₄ : J – Maximum Radiant flux bin J
- x₅ : 0 – Full color distribution
- x₆ : E – Test Current =150mA

Bin Information

Radiant Flux Bin Limits (CAT)

Bin ID	Radiant Flux, Φ_e (mW)	
	Min.	Max.
F	65	85
G	85	110
H	110	140
J	140	180
K	180	230
L	230	280
M	280	330

Tolerance = $\pm 12\%$

Peak Wavelength Bin Limits (BIN)

Deep Red

Bin ID	Peak Wavelength(nm)	
	Min.	Max.
-	650	670

Far Red

Bin ID	Peak Wavelength(nm)	
	Min.	Max.
-	720	740

Royal Blue

Bin ID	Peak Wavelength(nm)	
	Min.	Max.
1	440	445
2	445	450
3	450	455
4	455	460

Tolerance = $\pm 1.0\text{nm}$

Forward Voltage Bin Limits (VF)

Bin ID	Forward Voltage, V_F (V)	
	Min.	Max.
H09	1.6	1.7
H10	1.7	1.8
H11	1.8	1.9
H12	1.9	2.0
H13	2.0	2.1
H14	2.1	2.2
H15	2.2	2.3
H16	2.3	2.4
H17	2.4	2.5
H18	2.5	2.6
G01	2.6	2.7
G02	2.7	2.8
G03	2.8	2.9
G04	2.9	3.0
G05	3.0	3.1
G06	3.1	3.2
G07	3.2	3.3
G08	3.3	3.4
G09	3.4	3.5
G10	3.5	3.6
G11	3.6	3.7

Tolerance = $\pm 0.1\text{V}$

Example of bin information on reel and packaging label:

CAT : G – Radiant flux bin G
 BIN : - – Full distribution
 VF : H15 – VF bin H15

Figure 3: Spectral Power Distribution

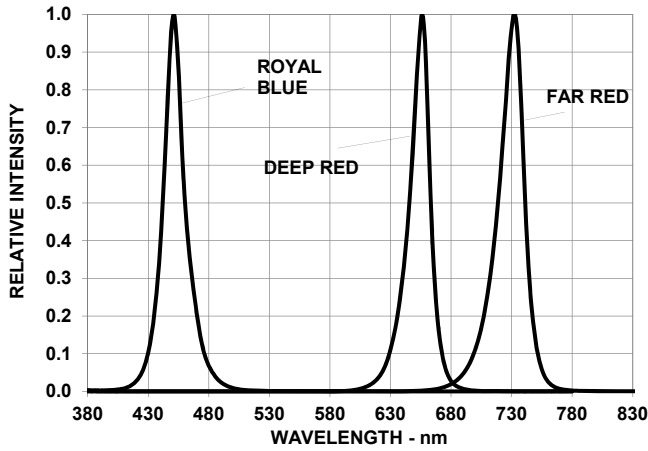

Figure 4: Forward Current vs. Forward Voltage

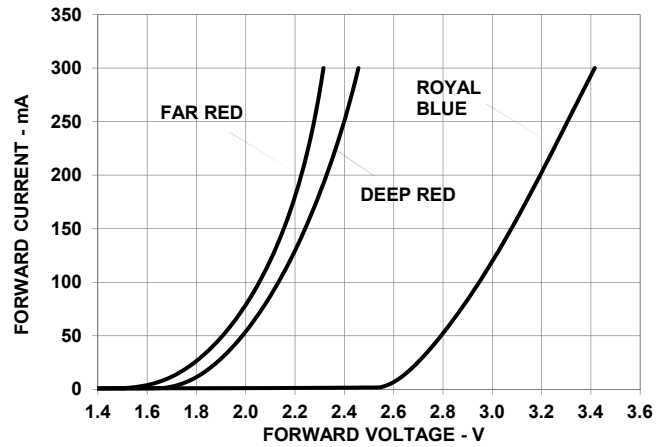

Figure 5: Relative Radiant Flux vs. Mono Pulse Current

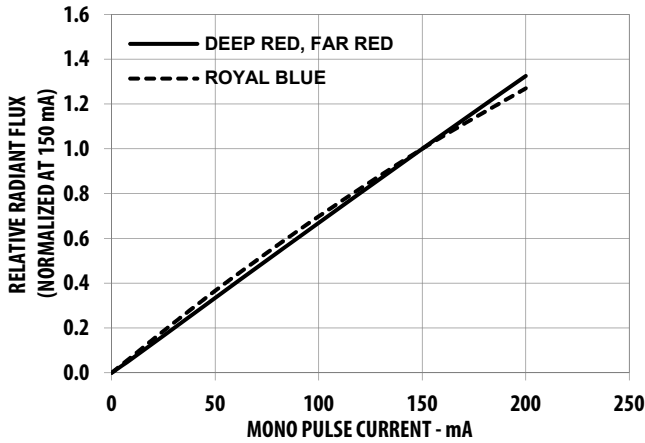

Figure 6: Radiation Pattern

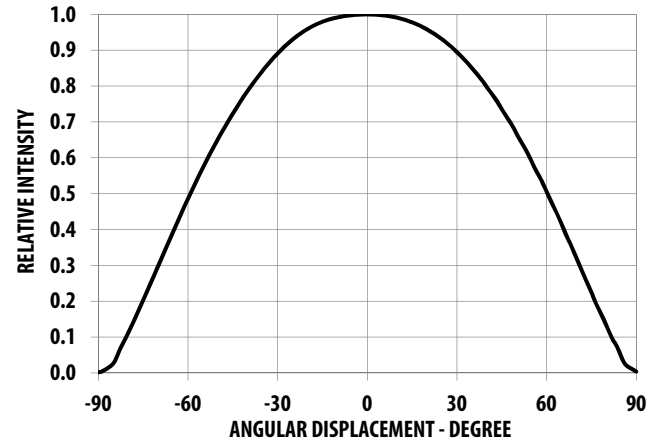

Figure 7: Peak Wavelength Shift vs. Mono Pulse Current

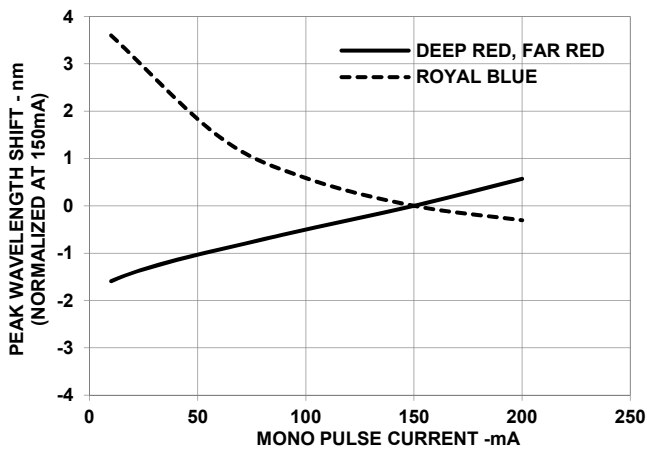

Figure 8: Forward Voltage Shift vs. Junction Temperature

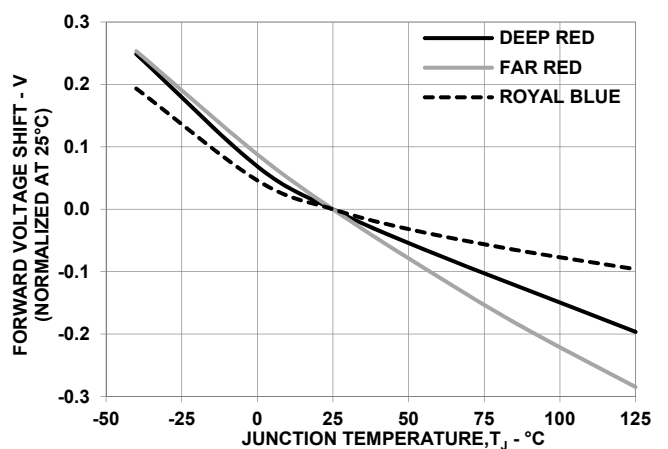

Figure 9: Relative Light Output vs. Junction Temperature

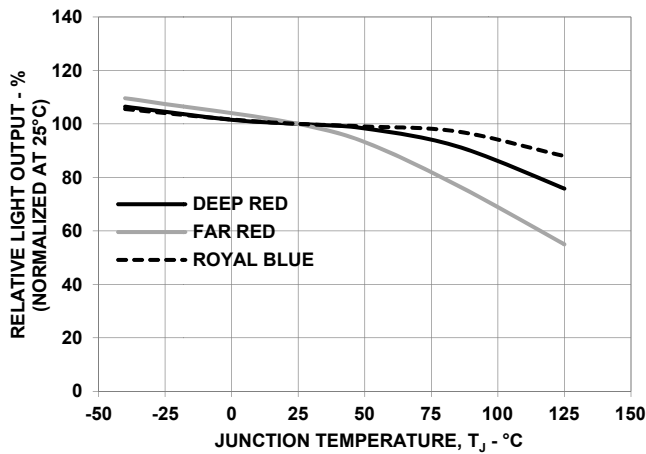

Figure 10: Peak Wavelength Shift vs. Junction Temperature

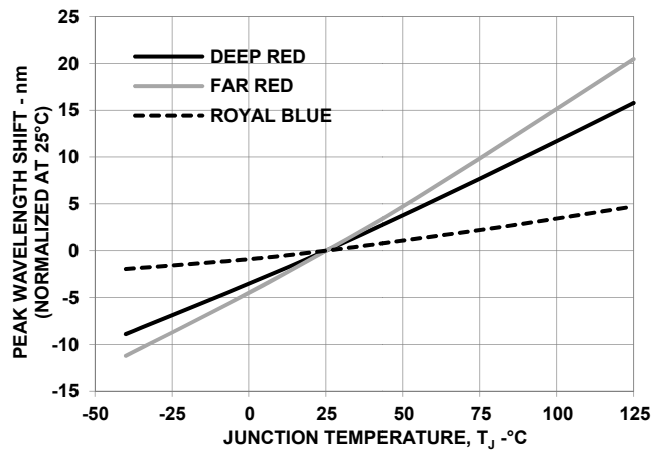

Figure 11: Maximum Forward Current vs. Ambient Temperature. Derated based on T_{JMAX} = 125°C

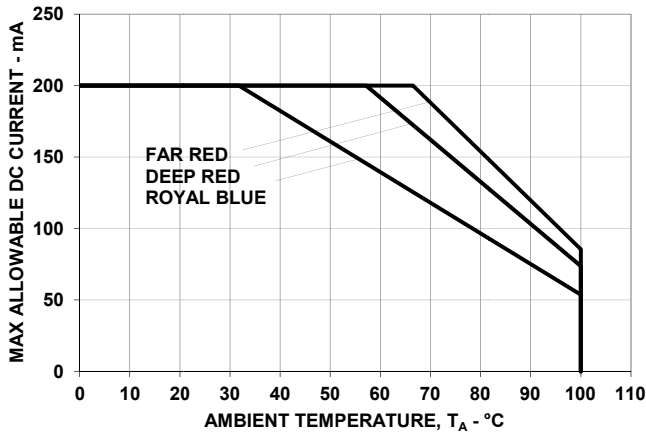

Figure 12: Maximum Forward Current vs. Solder Point Temperature. Derated based on T_{JMAX} = 125°C

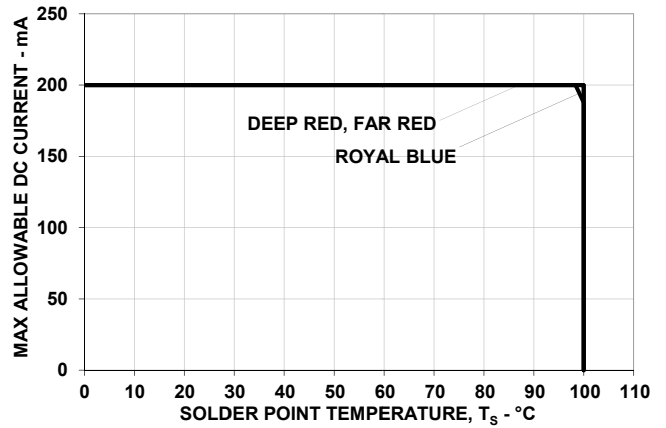

Figure 13: Pulse Handling Capability at T_s ≤ 100°C (Deep Red)

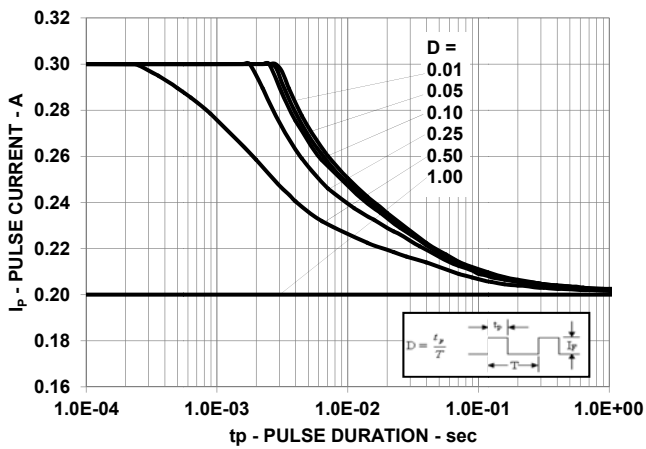

Figure 14: Pulse Handling Capability at T_s ≤ 100°C (Far Red)

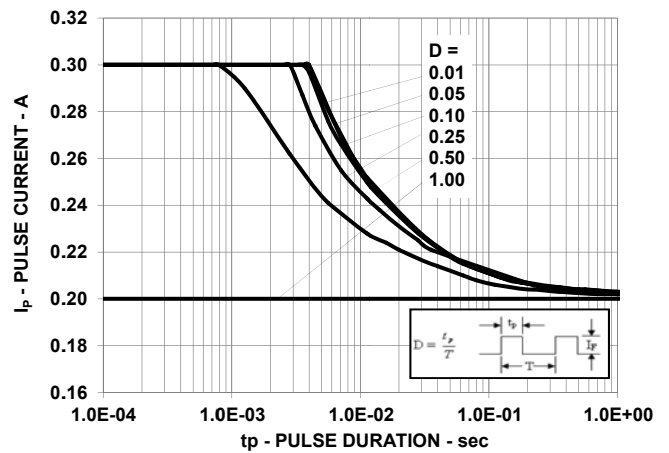

Figure 15: Pulse Handling Capability at $T_s \leq 98^\circ\text{C}$ (Royal Blue)

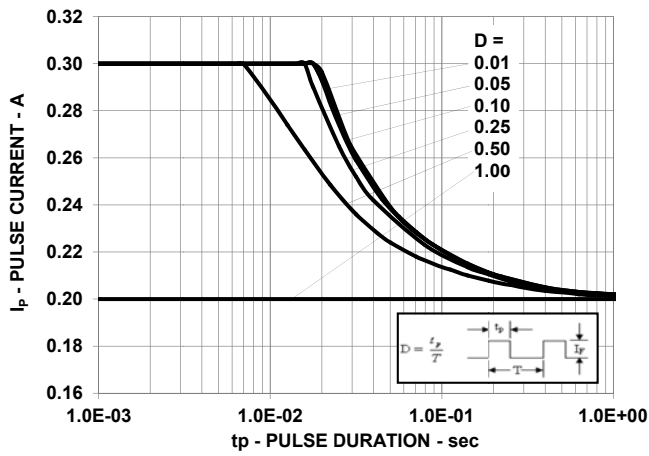

Figure 16: Pulse Handling Capability at $T_s = 100^\circ\text{C}$ (Royal Blue)

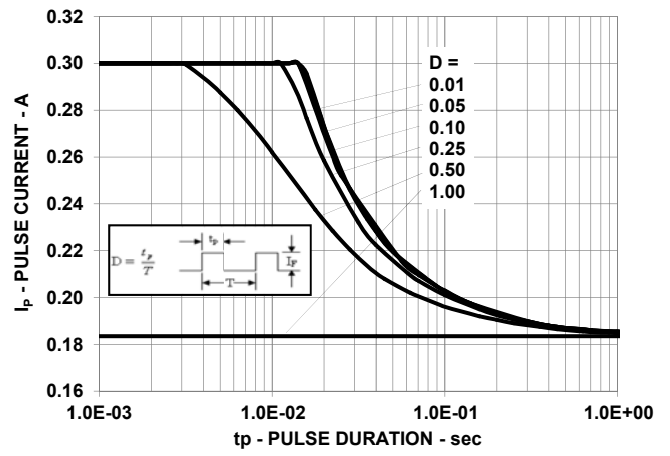
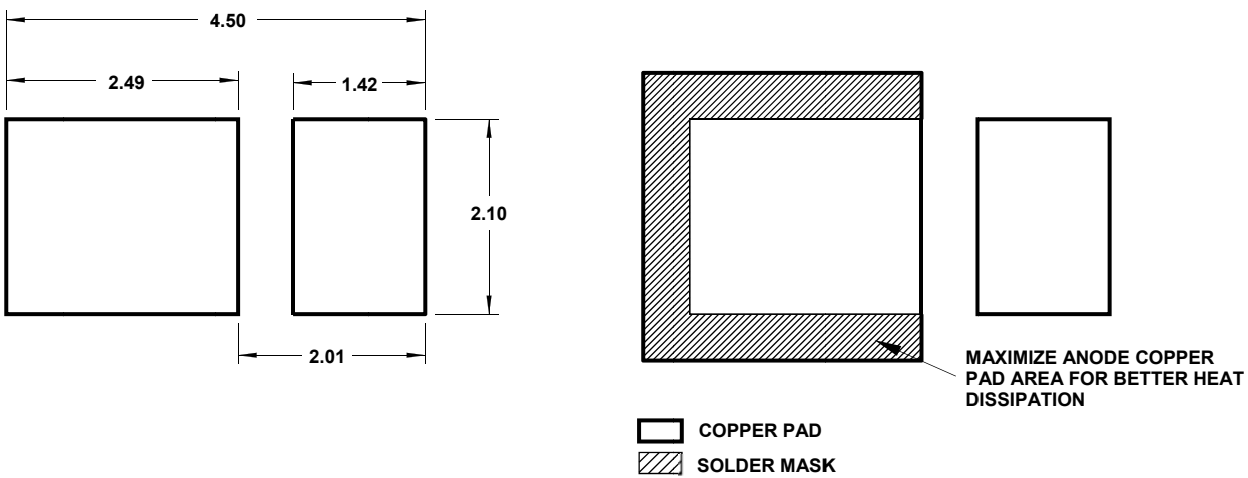
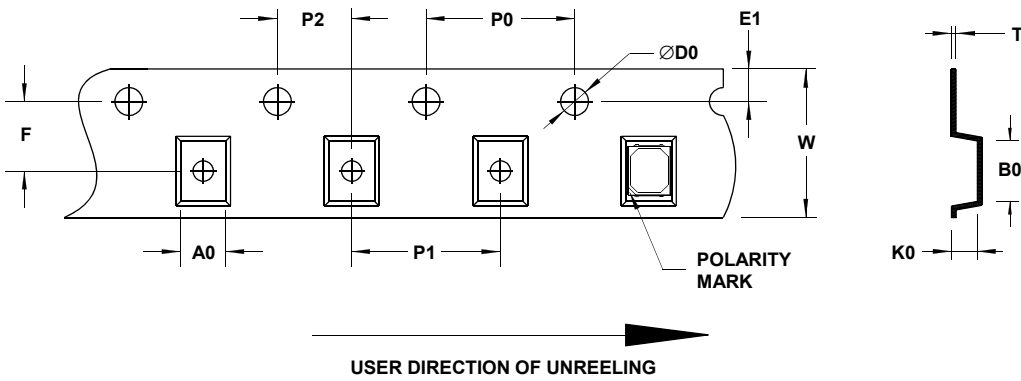

Figure 17: Recommended Soldering Land Pattern



NOTE: All dimensions are in millimeters (mm).

Figure 18: Carrier Tape Dimensions



F	P0	P1	P2	D0	E1	W
3.5±0.05	4.0±0.1	4.0±0.1	2.0±0.05	1.55±0.05	1.75±0.1	8.0±0.2

T	B0	K0	A0
0.2±0.05	3.8±0.1	1.05±0.1	3.1±0.1

NOTE:

1. All dimensions in millimeters (mm).
2. Tolerance is ±0.20mm unless otherwise specified.

Figure 19: Reel Dimensions

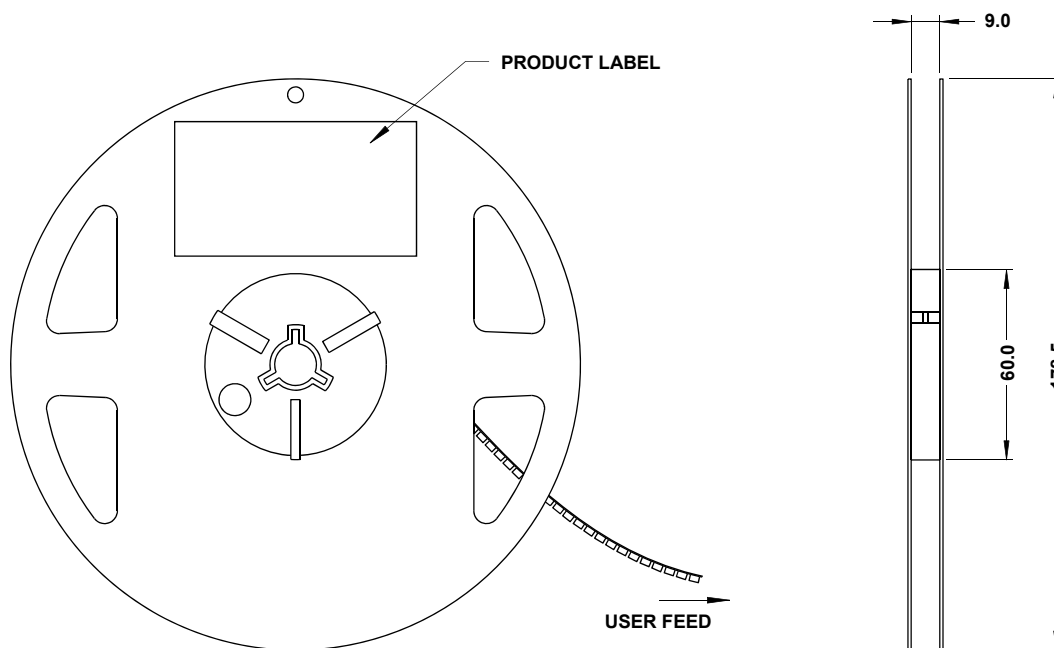

NOTE: All dimensions are in millimeters (mm).

Precautionary Notes

Soldering

- Do not perform reflow soldering more than twice. Observe necessary precautions of handling moisture-sensitive device as stated in the following section.
- Do not apply any pressure or force on the LED during reflow and after reflow when the LED is still hot.
- Use reflow soldering to solder the LED. Use hand soldering only for rework if unavoidable, but it must be strictly controlled to following conditions:
 - Soldering iron tip temperature = 315°C max.
 - Soldering duration = 3sec max.
 - Number of cycles = 1 only
 - Power of soldering iron = 50W max.
- Do not touch the LED package body with the soldering iron except for the soldering terminals, as it may cause damage to the LED.
- Confirm beforehand whether the functionality and performance of the LED is affected by soldering with hand soldering.

Figure 20: Recommended Lead-Free Reflow Soldering Profile

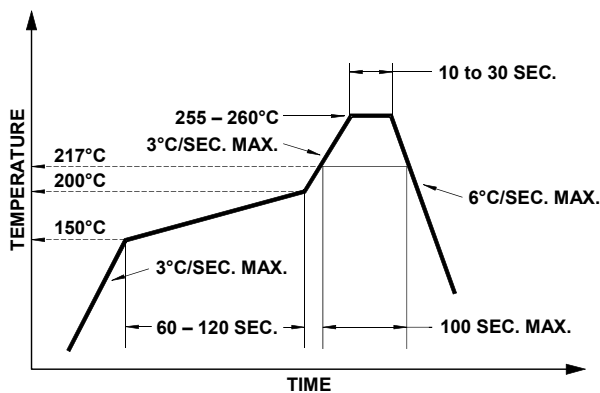
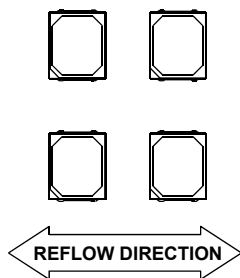

Figure 21: Recommended Board Reflow Direction



Handling Precautions

The encapsulation material of the LED is made of silicone for better product reliability. Compared to epoxy encapsulant, which is hard and brittle, silicone is softer and flexible. Observe special handling precautions during assembly of silicone encapsulated LED products. Failure to comply might lead to damage and premature failure of the LED. Refer to Broadcom Application Note AN5288, *Silicone Encapsulation for LED: Advantages and Handling Precautions*, for additional information.

- Do not poke sharp objects into the silicone encapsulant. Sharp objects, such as tweezers or syringes, might apply excessive force or even pierce through the silicone and induce failures to the LED die or wire bond.
- Do not touch the silicone encapsulant. Uncontrolled force acting on the silicone encapsulant might result in excessive stress on the wire bond. Hold the LED only by the body.
- Do not stack assembled PCBs together. Use an appropriate rack to hold the PCBs.
- Surface of silicone material attracts dust and dirt easier than epoxy due to its surface tackiness. To remove foreign particles on the surface of silicone, use a cotton bud with isopropyl alcohol (IPA). During cleaning, rub the surface gently without putting too much pressure on the silicone. Ultrasonic cleaning is not recommended.
- For automated pick and place, Broadcom has tested a nozzle size with an outer diameter of 3.5mm to work with this LED. However, due to the possibility of variations in other parameters such as pick and place machine maker/model, and other settings of the machine, verify that the selected nozzle will not cause damage to the LED.

Handling of Moisture-Sensitive Devices

This product has a Moisture Sensitive Level 3 rating per JEDEC J-STD-020. Refer to Broadcom Application Note AN5305, *Handling of Moisture Sensitive Surface Mount Devices* for additional details and a review of proper handling procedures.

- Before use:
 - An unopened moisture barrier bag (MBB) can be stored at <40°C/90% RH for 12 months. If the actual shelf life has exceeded 12 months and the Humidity Indicator Card (HIC) indicates that baking

is not required, then it is safe to reflow the LEDs per the original MSL rating.

- Do not open the MBB prior to assembly (for example, for IQC). If unavoidable, MBB must be properly resealed with fresh desiccant and HIC. The exposed duration must be taken in as floor life.
- Control after opening the MBB:
 - Read the HIC immediately upon opening of MBB.
 - Keep the LEDs at <30°/60%RH at all times, and complete all high temperature-related processes, including soldering, curing or rework within 168 hours.
- Control for unfinished reel:

Store unused LEDs in a sealed MBB with desiccant or a desiccator at <5% RH.
- Control of assembled boards:

If the PCB soldered with the LEDs is to be subjected to other high-temperature processes, store the PCB in a sealed MBB with desiccant or desiccator at <5% RH to ensure that all LEDs have not exceeded their floor life of 168 hours.
- Baking is required if:
 - The HIC indicator indicates a change in color for 10% and 5%, as stated on the HIC.
 - The LEDs are exposed to conditions of >30°C/60% RH at any time.
 - The LED's floor life exceeded 168 hours.

The recommended baking condition is: 60±5°C for 20 hours.

Baking can only be done once.
- Storage:

The soldering terminals of these Broadcom LEDs are silver plated. If the LEDs are exposed in ambient environment for too long, the silver plating might be oxidized, thus affecting its solderability performance. As such, keep unused LEDs in a sealed MBB with desiccant or in a desiccator at <5% RH.

Application Precautions

- The drive current of the LED must not exceed the maximum allowable limit across temperature as stated in the data sheet. Constant current driving is recommended to ensure consistent performance.
- Circuit design must cater to the whole range of forward voltage (V_F) of the LEDs to ensure the intended drive current can always be achieved.
- The LED exhibits slightly different characteristics at different drive currents, which may result in a larger

variation of performance (meaning: intensity, wavelength, and forward voltage). Set the application current as close as possible to the test current to minimize these variations.

- Do not use the LED in the vicinity of material with sulfur content or in environments of high gaseous sulfur compounds and corrosive elements. Examples of material that might contain sulfur are rubber gaskets, room- temperature vulcanizing (RTV) silicone rubber, rubber gloves, and so on. Prolonged exposure to such environments may affect the optical characteristics and product life.
- White LEDs must not be exposed to acidic environments and must not be used in the vicinity of any compound that may have acidic outgas, such as, but not limited to, acrylate adhesive. These environments have an adverse effect on LED performance.
- This LED is designed to have enhanced gas corrosion resistance. Its performance has been tested according to the conditions below:
 - IEC 60068-2-43: 25°C/75% RH, H₂S 15ppm, 21 days.
 - IEC 60068-2-42: 25°C/75% RH, SO₂ 25ppm, 21 days.
 - IEC 60068-2-60: 25°C/75% RH, SO₂ 200ppb, NO₂ 200ppb, H₂S 10ppb, Cl₂ 10ppb, 21 days.

As actual application might not be exactly similar to the test conditions, do verify that the LED will not be damaged by prolonged exposure in the intended environment.
- Avoid rapid change in ambient temperature, especially in high-humidity environments, because they cause condensation on the LED.
- If the LED is intended to be used in harsh or outdoor environment, protect the LED against damages caused by rain, water, dust, oil, corrosive gases, external mechanical stresses, and so on.

Thermal Management

The optical, electrical, and reliability characteristics of the LED are affected by temperature. Keep the junction temperature (T_J) of the LED below the allowable limit at all times. T_J can be calculated as follows:

$$T_J = T_A + R_{\theta J-A} \times I_F \times V_{Fmax}$$

where:

T_A = ambient temperature (°C)

$R_{\theta J-A}$ = thermal resistance from LED junction to ambient (°C/W)

I_F = forward current (A)

V_{Fmax} = maximum forward voltage (V)

The complication of using this formula lies in T_A and $R_{\theta J-A}$. Actual T_A is sometimes subjective and hard to determine. $R_{\theta J-A}$ varies from system to system depending on design and is usually not known.

Another way of calculating T_J is by using the solder point temperature, T_S as follows:

$$T_J = T_S + R_{\theta J-S} \times I_F \times V_{Fmax}$$

where:

T_S = LED solder point temperature as shown in the following figure (°C)

$R_{\theta J-S}$ = thermal resistance from junction to solder point (°C/W)

I_F = forward current (A)

V_{Fmax} = maximum forward voltage (V)

Figure 22: Solder Point Temperature on PCB

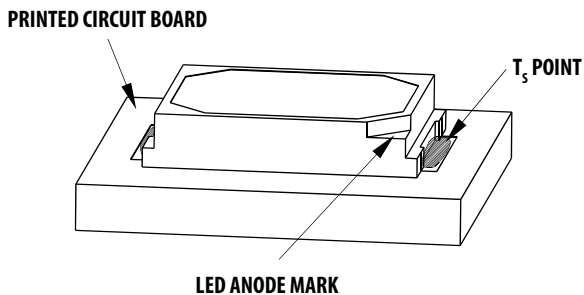

T_S can be easily measured by mounting a thermocouple on the soldering joint as shown in preceding figure, while $R_{\theta J-S}$ is provided in the data sheet. Verify the T_S of the LED in the final product to ensure that the LEDs are operating within all maximum ratings stated in the data sheet.

Eye Safety Precautions

LEDs may pose optical hazards when in operation. Do not look directly at operating LEDs because it might be harmful to the eyes. For safety reasons, use appropriate shielding or personal protective equipment.

Disclaimer

Broadcom's products and software are not specifically designed, manufactured, or authorized for sale as parts, components, or assemblies for the planning, construction, maintenance, or direct operation of a nuclear facility or for use in medical devices or applications. The customer is solely responsible, and waives all rights to make claims against Broadcom or its suppliers, for all loss, damage, expense, or liability in connection with such use.

Broadcom, the pulse logo, Connecting everything, Avago Technologies, Avago, and the A logo are among the trademarks of Broadcom and/or its affiliates in the United States, certain other countries and/or the EU.

Copyright © 2017 by Broadcom. All Rights Reserved.

The term "Broadcom" refers to Broadcom Limited and/or its subsidiaries. For more information, please visit www.broadcom.com.

Broadcom reserves the right to make changes without further notice to any products or data herein to improve reliability, function, or design. Information furnished by Broadcom is believed to be accurate and reliable. However, Broadcom does not assume any liability arising out of the application or use of this information, nor the application or use of any product or circuit described herein, neither does it convey any license under its patent rights nor the rights of others.



X-ON Electronics

Largest Supplier of Electrical and Electronic Components

Click to view similar products for [High Power LEDs - Single Colour](#) category:

Click to view products by [Broadcom](#) manufacturer:

Other Similar products are found below :

[GA CSSPM1.23-KTLP-W3-0-350-R18](#) [L135-L567003500000](#) [L1CU-VLT1000000000](#) [L1C1-VLT1000000000](#) [KY DDLM31.FY-8H7J-5F5G-W4A4-140-R18](#) [KY DDLM31.23-8F5H-36-C4U4-140-R18](#) [LS G6SP.01-7C8D-68-G3R3](#) [KR DDLM31.23-5G7H-25-C4U4-140-R18](#) [KT DDLM31.13-6H7J-36-W4A4-140-R18](#) [KS DDLM31.23-8E6G-68-C4U4-140-R18](#) [KB DDLM31.13-6D7E-25-24A4-140-R18](#) [GT CS8PM1.13-LSLU-26-1-350-B-R18](#) [L128-PCB1003500000](#) [GH CS8PM1.24-4T2U-1-0-350-R33](#) [GT CSHPM1.13-LSLU-26-1-350-B-R18](#) [XPEBRY-L1-0000-00S02](#) [XQEBLU-00-0000-000000Z02](#) [SPHWH2L3D30ED4V0H3](#) [XQEBLU-00-0000-000000202](#) [LUWCQ7P-LPLR-5E8G-1-K](#) [LTPL-C034UVH410](#) [XPEBBL-L1-R250-00302](#) [XPEROY-L1-0000-00B02](#) [GD CSSPM1.14-UOVJ-W4-1](#) [LST1-01F06-GRN1-00](#) [KY DMLQ31.23-HYKX-46-J3T3](#) [GD CS8PM1.14-UOVJ-W4-1](#) [XQEEPR-00-0000-000000A01-SB01](#) [LST1-01G01-UV02-00](#) [LST1-01F06-RYL1-00](#) [LST1-01F06-FRD1-00](#) [LST1-01G01-UV01-00](#) [LST1-01G01-PRD1-00](#) [XQEROY-00-0000-000000Q01-SB01](#) [LST1-01G01-UV03-00](#) [LST1-01G01-RYL1-00](#) [L135-A589003500000](#) [L135-L567L00000000](#) [L1C1-GRN1000000000](#) [LA G6SP-DAFA-24-1](#) [LS G6SP-CADB-1-1-Z](#) [LY H9PP-HZJZ-46-1](#) [SMTL6-RC](#) [MLEBLU-A1-0000-000U01](#) [MLEBLU-A1-0000-000U05](#) [MLEGRN-A1-0000-000101](#) [MLEGRN-A1-0000-000X02](#) [MLESRD-A1-0000-000W01](#) [XBDAMB-00-0000-000000701](#) [XBDAMB-00-0000-000000801](#)