

# ATF-55143

## Low Noise Enhancement Mode Pseudomorphic HEMT in a Surface Mount Plastic Package



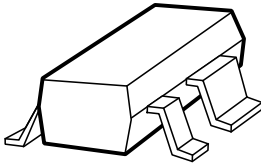
### Data Sheet

#### Description

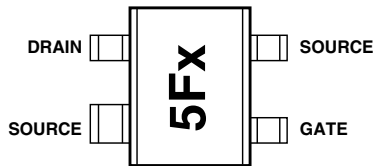
Avago Technologies' ATF-55143 is a high dynamic range, very low noise, single supply E-PHEMT housed in a 4-lead SC-70 (SOT-343) surface mount plastic package.

The combination of high gain, high linearity and low noise makes the ATF-55143 ideal for cellular/PCS handsets, wireless data systems (WLL/RLL, WLAN and MMDS) and other systems in the 450 MHz to 6 GHz frequency range.

#### Surface Mount Package SOT-343



#### Pin Connections and Package Marking



Note:  
Top View. Package marking provides orientation and identification

"5F" = Device Code  
"x" = Date code character identifies month of manufacture.

#### Features

- High linearity performance
- Single Supply Enhancement Mode Technology<sup>(1)</sup>
- Very low noise figure
- Excellent uniformity in product specifications
- 400 micron gate width
- Low cost surface mount small plastic package SOT-343 (4 lead SC-70)
- Tape-and-Reel packaging option available
- Lead Free Option Available


#### Specifications

- 2 GHz; 2.7V, 10 mA (Typ.)
- 24.2 dBm output 3<sup>rd</sup> order intercept
- 14.4 dBm output power at 1 dB gain compression
- 0.6 dB noise figure
- 17.7 dB associated gain
- Lead-free option available

#### Applications

- Low noise amplifier for cellular/PCS handsets
- LNA for WLAN, WLL/RLL and MMDS applications
- General purpose discrete E-PHEMT for other ultra low noise applications

Note:  
1. Enhancement mode technology requires positive Vgs, thereby eliminating the need for the negative gate voltage associated with conventional depletion mode devices.



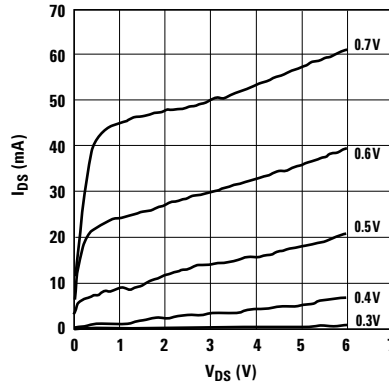
**Attention: Observe precautions for handling electrostatic sensitive devices.**  
ESD Machine Model (Class A)  
ESD Human Body Model (Class 0)  
Refer to Avago Application Note A004R:  
Electrostatic Discharge Damage and Control.

# ATF-55143 Absolute Maximum Ratings<sup>[1]</sup>

Symbol	Parameter	Units	Absolute Maximum
$V_{DS}$	Drain-Source Voltage <sup>[2]</sup>	V	5
$V_{GS}$	Gate-Source Voltage <sup>[2]</sup>	V	-5 to 1
$V_{GD}$	Gate Drain Voltage <sup>[2]</sup>	V	-5 to 1
$I_{DS}$	Drain Current <sup>[2]</sup>	mA	100
$I_{GS}$	Gate Current <sup>[5]</sup>	mA	1
$P_{diss}$	Total Power Dissipation <sup>[3]</sup>	mW	270
$P_{in\ max.}$	RF Input Power <sup>[5]</sup> ( $V_{ds}=2.7V, I_{ds}=10mA$ )	dBm	10
	( $V_{ds}=0V, I_{ds}=0mA$ )	dBm	10
$T_{CH}$	Channel Temperature	°C	150
$T_{STG}$	Storage Temperature	°C	-65 to 150
$\theta_{jc}$	Thermal Resistance <sup>[4]</sup>	°C/W	235
	ESD (Human Body Model)	V	200
	ESD (Machine Model)	V	25

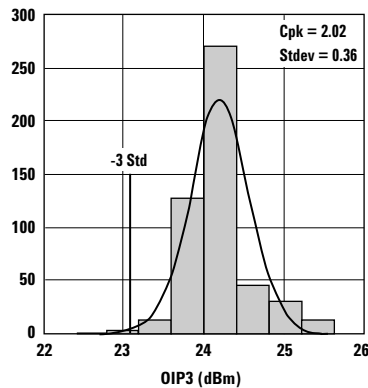
**Notes:**

1. Operation of this device above any one of these parameters may cause permanent damage.
2. Assumes DC quiescent conditions.
3. Source lead temperature is 25°C. Derate 4.3 mW/°C for  $T_L > 87^\circ\text{C}$ .
4. Thermal resistance measured using 150°C Liquid Crystal Measurement method.
5. Device can safely handle +10 dBm RF Input Power as long as  $I_{GS}$  is limited to 1 mA.  $I_{GS}$  at  $P_{1dB}$  drive level is bias circuit dependent. See applications section for additional information.

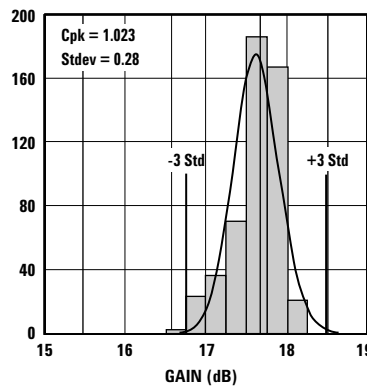


**Figure 1. Typical I-V Curves.**  
( $V_{GS} = 0.1\text{ V per step}$ )

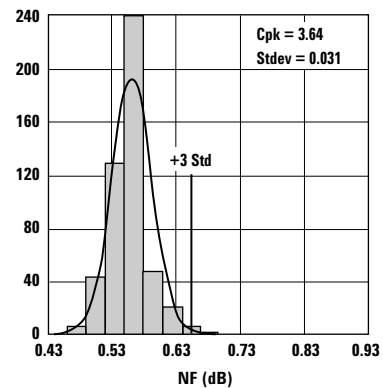
## Product Consistency Distribution Charts<sup>[6,7]</sup>



**Figure 2. OIP3 @ 2.7V, 10 mA.**  
LSL = 22.0, Nominal = 24.2



**Figure 3. Gain @ 2.7V, 10 mA.**  
USL = 18.5, LSL = 15.5, Nominal = 17.7



**Figure 4. NF @ 2.7V, 10 mA.**  
USL = 0.9, Nominal = 0.6

**Notes:**

6. Distribution data sample size is 500 samples taken from 6 different wafers. Future wafers allocated to this product may have nominal values anywhere between the upper and lower limits.
7. Measurements made on production test board. This circuit represents a trade-off between an optimal noise match and a realizable match based on production test equipment. Circuit losses have been de-embedded from actual measurements.

## ATF-55143 Electrical Specifications

$T_A = 25^\circ\text{C}$ , RF parameters measured in a test circuit for a typical device

Symbol	Parameter and Test Condition	Units	Min.	Typ. <sup>[2]</sup>	Max.	
Vgs	Operational Gate Voltage	Vds = 2.7V, Ids = 10 mA	V	0.3	0.65	
Vth	Threshold Voltage	Vds = 2.7V, Ids = 2 mA	V	0.18	0.53	
Idss	Saturated Drain Current	Vds = 2.7V, Vgs = 0V	$\mu\text{A}$	—	3	
Gm	Transconductance	Vds = 2.7V, gm = $\Delta\text{Idss}/\Delta\text{Vgs}$ ; $\Delta\text{Vgs} = 0.75 - 0.7 = 0.05\text{V}$	mmho	110	220	
Igss	Gate Leakage Current	Vgd = Vgs = -2.7V	$\mu\text{A}$	—	95	
NF	Noise Figure <sup>[1]</sup>	f = 2 GHz	Vds = 2.7V, Ids = 10 mA	dB	—	0.6
		f = 900 MHz	Vds = 2.7V, Ids = 10 mA	dB	—	0.3
Ga	Associated Gain <sup>[1]</sup>	f = 2 GHz	Vds = 2.7V, Ids = 10 mA	dB	15.5	17.7
		f = 900 MHz	Vds = 2.7V, Ids = 10 mA	dB	—	21.6
OIP3	Output 3 <sup>rd</sup> Order Intercept Point <sup>[1]</sup>	f = 2 GHz	Vds = 2.7V, Ids = 10 mA	dBm	22.0	24.2
		f = 900 MHz	Vds = 2.7V, Ids = 10 mA	dBm	—	22.3
P1dB	1dB Compressed Output Power <sup>[1]</sup>	f = 2 GHz	Vds = 2.7V, Ids = 10 mA	dBm	—	14.4
		f = 900 MHz	Vds = 2.7V, Ids = 10 mA	dBm	—	14.2

Notes:

1. Measurements obtained using production test board described in Figure 5.
2. Typical values determined from a sample size of 500 parts from 6 wafers.

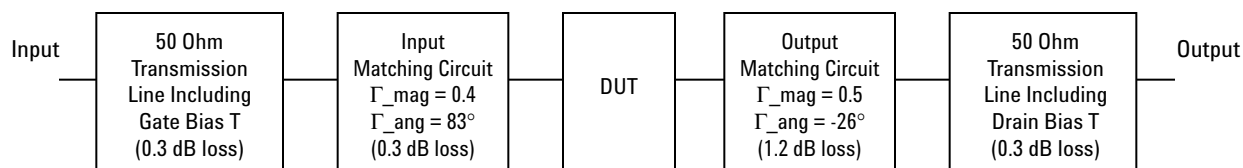


Figure 5. Block diagram of 2 GHz production test board used for Noise Figure, Associated Gain, P1dB, OIP3, and IIP3 measurements. This circuit represents a trade-off between an optimal noise match, maximum OIP3 match and associated impedance matching circuit losses. Circuit losses have been de-embedded from actual measurements.

# ATF-55143 Typical Performance Curves

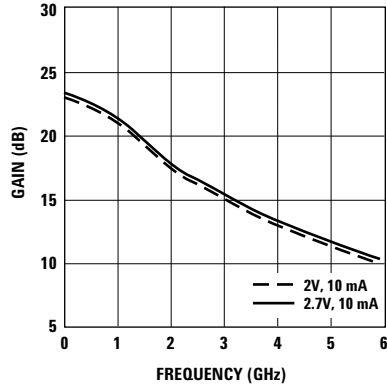


Figure 6. Gain vs. Bias over Frequency.<sup>[1]</sup>

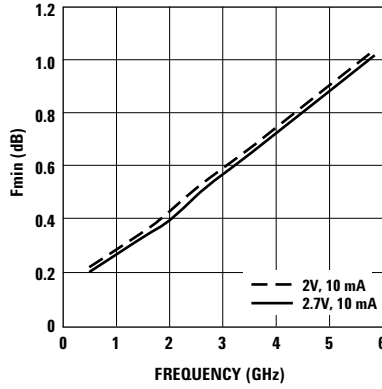


Figure 7. Fmin vs. Frequency and Bias.

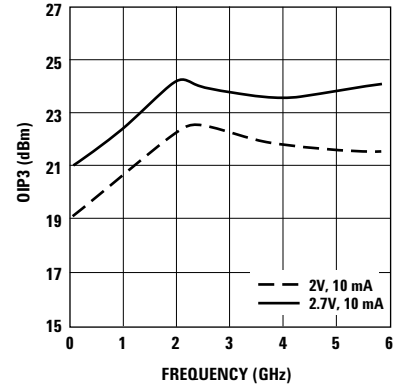


Figure 8. OIP3 vs. Bias over Frequency.<sup>[1]</sup>

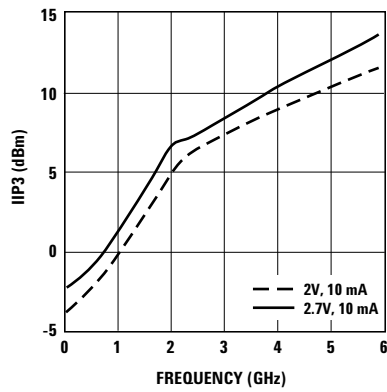


Figure 9. IIP3 vs. Bias over Frequency.<sup>[1]</sup>

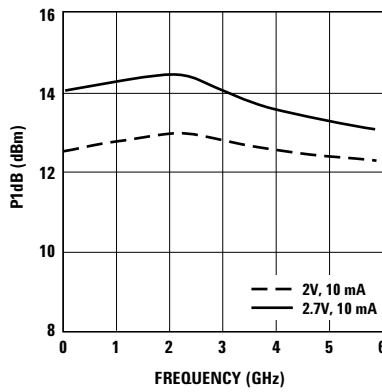


Figure 10. P1dB vs. Bias over Frequency.<sup>[1,2]</sup>

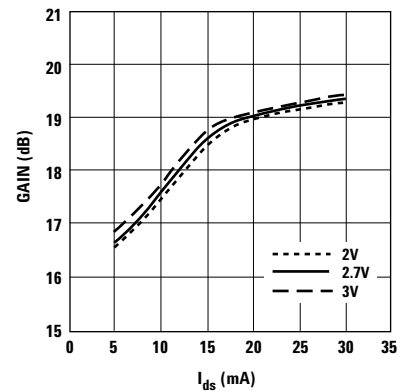


Figure 11. Gain vs.  $I_{ds}$  and  $V_{ds}$  at 2 GHz.<sup>[1]</sup>

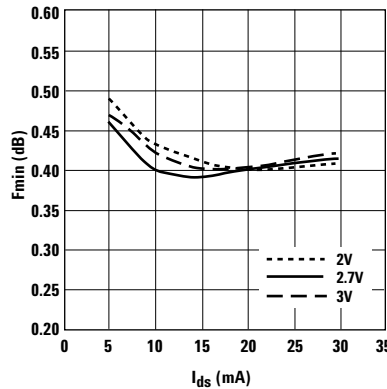


Figure 12. Fmin vs.  $I_{ds}$  and  $V_{ds}$  at 2 GHz.

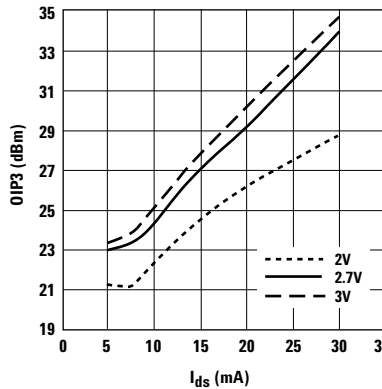


Figure 13. OIP3 vs.  $I_{ds}$  and  $V_{ds}$  at 2 GHz.<sup>[1]</sup>

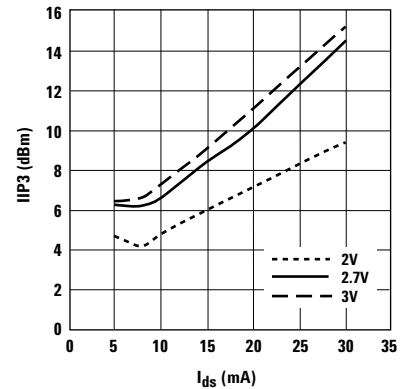


Figure 14. IIP3 vs.  $I_{ds}$  and  $V_{ds}$  at 2 GHz.<sup>[1]</sup>

## Notes:

- Measurements at 2 GHz were made on a fixed tuned production test board that was tuned for optimal OIP3 match with reasonable noise figure at 2.7 V, 10 mA bias. This circuit represents a trade-off between optimal noise match, maximum OIP3 match and a realizable match based on production test board requirements. Measurements taken above and below 2 GHz were made using a double stub tuner at the input tuned for low noise and a double stub tuner at the output tuned for maximum OIP3. Circuit losses have been de-embedded from actual measurements.
- P1dB measurements are performed with passive biasing. Quiescent drain current,  $I_{dsq}$ , is set with zero RF drive applied. As P1dB is approached, the drain current may increase or decrease depending on frequency and dc bias point. At lower values of  $I_{dsq}$ , the device is running close to class B as power output approaches P1dB. This results in higher P1dB and higher PAE (power added efficiency) when compared to a device that is driven by a constant current source as is typically done with active biasing. As an example, at a  $V_{ds} = 2.7V$  and  $I_{dsq} = 5 mA$ ,  $I_d$  increases to 15 mA as a P1dB of +14.5 dBm is approached.

## ATF-55143 Typical Performance Curves, continued

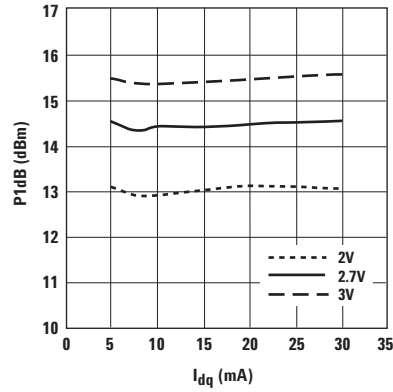


Figure 15. P1dB vs.  $I_{dq}$  and  $V_{ds}$  at 2 GHz.<sup>[1,2]</sup>

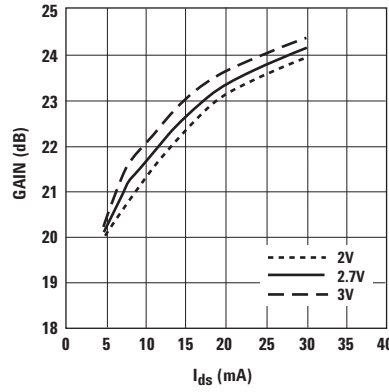


Figure 16. Gain vs.  $I_{ds}$  and  $V_{ds}$  at 900 MHz.<sup>[1]</sup>

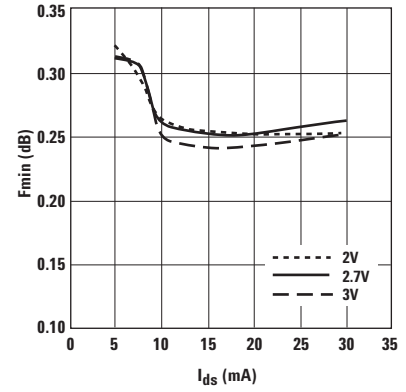


Figure 17.  $F_{min}$  vs.  $I_{ds}$  and  $V_{ds}$  at 900 MHz.

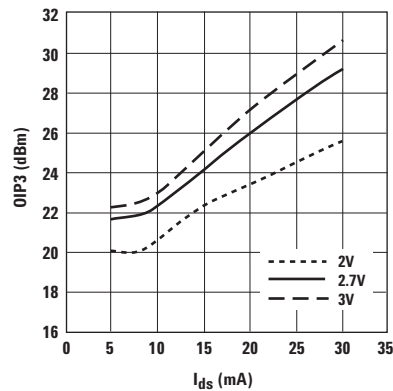


Figure 18. OIP3 vs.  $I_{ds}$  and  $V_{ds}$  at 900 MHz.<sup>[1]</sup>

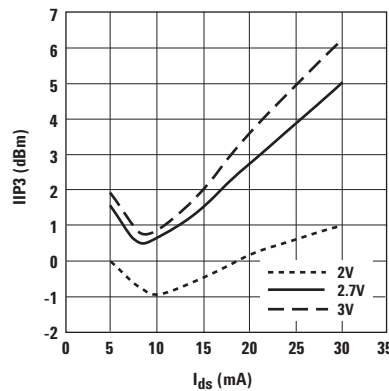


Figure 19. IIP3 vs.  $I_{ds}$  and  $V_{ds}$  at 900 MHz.<sup>[1]</sup>

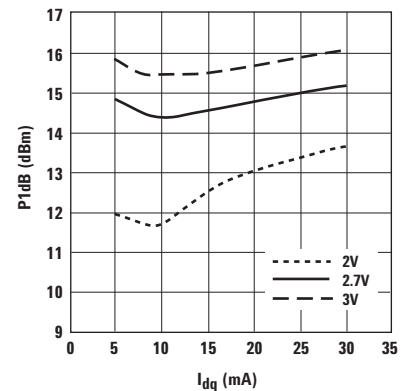


Figure 20. P1dB vs.  $I_{dq}$  and  $V_{ds}$  at 900 MHz.<sup>[1,2]</sup>

### Notes:

- Measurements at 2 GHz were made on a fixed tuned production test board that was tuned for optimal OIP3 match with reasonable noise figure at 2.7 V, 10 mA bias. This circuit represents a trade-off between optimal noise match, maximum OIP3 match and a realizable match based on production test board requirements. Measurements taken above and below 2 GHz were made using a double stub tuner at the input tuned for low noise and a double stub tuner at the output tuned for maximum OIP3. Circuit losses have been de-embedded from actual measurements.
- P1dB measurements are performed with passive biasing. Quiescent drain current,  $I_{dsq}$ , is set with zero RF drive applied. As P1dB is approached, the drain current may increase or decrease depending on frequency and dc bias point. At lower values of  $I_{dsq}$ , the device is running close to class B as power output approaches P1dB. This results in higher P1dB and higher PAE (power added efficiency) when compared to a device that is driven by a constant current source as is typically done with active biasing. As an example, at a  $V_{ds} = 2.7V$  and  $I_{dsq} = 5\text{ mA}$ ,  $I_d$  increases to 15 mA as a P1dB of +14.5 dBm is approached.

## ATF-55143 Typical Performance Curves, continued

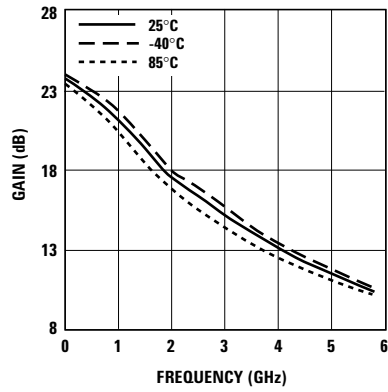


Figure 21. Gain vs. Temperature and Frequency with bias at 2.7V, 10 mA.<sup>[1]</sup>

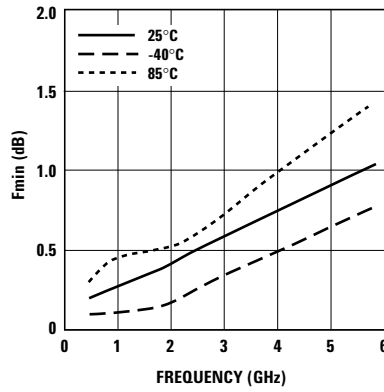


Figure 22. Fmin vs. Frequency and Temperature at 2.7V, 10 mA.

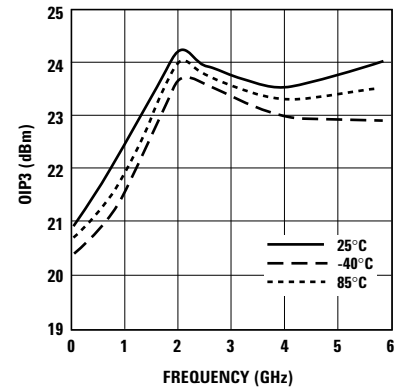


Figure 23. OIP3 vs. Temperature and Frequency with bias at 2.7V, 10 mA.<sup>[1]</sup>

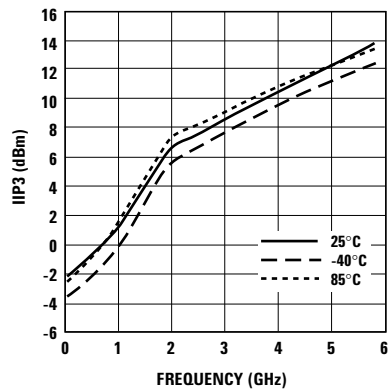


Figure 24. IIP3 vs. Temperature and Frequency with bias at 2.7V, 10 mA.<sup>[1]</sup>

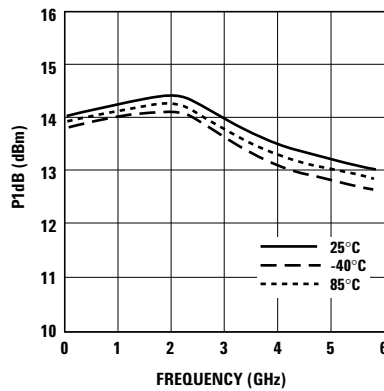


Figure 25. P1dB vs. Temperature and Frequency with bias at 2.7V, 10 mA.<sup>[1,2]</sup>

### Notes:

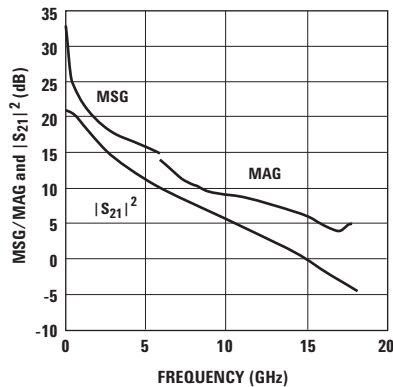
1. Measurements at 2 GHz were made on a fixed tuned production test board that was tuned for optimal OIP3 match with reasonable noise figure at 2.7 V, 10 mA bias. This circuit represents a trade-off between optimal noise match, maximum OIP3 match and a realizable match based on production test board requirements. Measurements taken above and below 2 GHz were made using a double stub tuner at the input tuned for low noise and a double stub tuner at the output tuned for maximum OIP3. Circuit losses have been de-embedded from actual measurements.
2. P1dB measurements are performed with passive biasing. Quiescent drain current,  $I_{dsq}$ , is set with zero RF drive applied. As P1dB is approached, the drain current may increase or decrease depending on frequency and dc bias point. At lower values of  $I_{dsq}$ , the device is running close to class B as power output approaches P1dB. This results in higher P1dB and higher PAE (power added efficiency) when compared to a device that is driven by a constant current source as is typically done with active biasing. As an example, at a  $V_{DS} = 2.7V$  and  $I_{dsq} = 5$  mA,  $I_d$  increases to 15 mA as a P1dB of +14.5 dBm is approached.

**ATF-55143 Typical Scattering Parameters,  $V_{DS} = 2V, I_{DS} = 10\text{ mA}$**

Freq. GHz	$S_{11}$			$S_{21}$		$S_{12}$		$S_{22}$		MSG/MAG dB
	Mag.	Ang.	dB	Mag.	Ang.	Mag.	Ang.	Mag.	Ang.	
0.1	0.998	-6.5	20.78	10.941	174.9	0.006	86.1	0.796	-4.2	32.61
0.5	0.963	-31.7	20.37	10.434	154.8	0.029	70.2	0.762	-20.4	25.56
0.9	0.894	-54.7	19.57	9.516	137.1	0.048	56.9	0.711	-34.4	22.97
1.0	0.879	-60.1	19.32	9.252	133.0	0.051	54	0.693	-37.3	22.59
1.5	0.793	-84.1	18.07	8.009	115.2	0.066	41.5	0.622	-49.6	20.84
1.9	0.731	-100.8	17.11	7.166	102.8	0.075	33.6	0.570	-57.1	19.80
2.0	0.718	-104.7	16.86	6.970	100.1	0.077	31.8	0.559	-58.7	19.57
2.5	0.657	-123.7	15.79	6.159	86.6	0.084	23.7	0.503	-66.3	18.65
3.0	0.611	-141.8	14.80	5.494	74.2	0.090	16.5	0.446	-73	17.86
4.0	0.561	-177.5	13.10	4.517	51.0	0.098	3.6	0.343	-87.6	16.64
5.0	0.558	149.4	11.52	3.768	29.3	0.102	-8.3	0.269	-104.4	15.68
6.0	0.566	122.5	10.06	3.183	9.4	0.104	-18.4	0.224	-120.4	14.08
7.0	0.583	99.7	8.78	2.748	-9.2	0.106	-28.5	0.189	-137.3	11.96
8.0	0.601	77.7	7.62	2.404	-27.4	0.105	-38.4	0.140	-149.3	10.40
9.0	0.636	57.5	6.63	2.147	-45.3	0.110	-44.7	0.084	-170	9.51
10.0	0.708	38.3	5.66	1.919	-64.6	0.117	-56.6	0.08	109.3	9.34
11.0	0.76	21.8	4.45	1.670	-83.1	0.119	-68.2	0.151	64.5	8.77
12.0	0.794	7.6	3.32	1.465	-100.2	0.121	-79.3	0.217	40.8	8.14
13.0	0.819	-7.8	2.29	1.302	-117.9	0.121	-91.4	0.262	20.8	7.55
14.0	0.839	-23.6	1.27	1.157	-136.7	0.122	-104.4	0.327	0.5	6.92
15.0	0.862	-37.9	-0.19	0.978	-155.2	0.115	-117.7	0.431	-16.4	6.14
16.0	0.853	-51.0	-1.83	0.810	-171.8	0.109	-129.4	0.522	-28.6	4.53
17.0	0.868	-60.1	-3.25	0.688	173.9	0.107	-139.9	0.588	-41.6	3.91
18.0	0.911	-70.3	-4.44	0.601	158.5	0.102	-153.2	0.641	-55.8	4.79

**Typical Noise Parameters,  $V_{DS} = 2V, I_{DS} = 10\text{ mA}$**

Freq GHz	$F_{min}$ dB	$\Gamma_{opt}$ Mag.	$\Gamma_{opt}$ Ang.	$R_{n/50}$	$G_a$ dB
0.5	0.21	0.65	17.5	0.13	24.84
0.9	0.26	0.60	22.6	0.12	22.86
1.0	0.27	0.55	27.0	0.12	22.39
1.9	0.42	0.55	49.4	0.11	18.77
2.0	0.43	0.54	51.7	0.11	18.42
2.4	0.50	0.45	61.5	0.10	17.14
3.0	0.59	0.40	78.1	0.09	15.50
3.9	0.73	0.26	111.9	0.07	13.62
5.0	0.92	0.21	172.5	0.06	12.05
5.8	1.04	0.24	-151.5	0.07	11.28
6.0	1.06	0.23	-144.5	0.08	11.12
7.0	1.22	0.28	-107.1	0.14	10.45
8.0	1.42	0.33	-75.5	0.24	9.84
9.0	1.57	0.43	-51.5	0.38	9.10
10.0	1.71	0.54	-33.3	0.57	8.03



**Figure 26. MSG/MAG and  $|S_{21}|^2$  vs. Frequency at 2V, 10 mA.**

Notes:

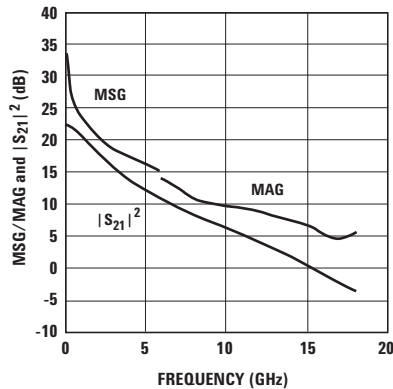
- $F_{min}$  values at 2 GHz and higher are based on measurements while the  $F_{min}$  below 2 GHz have been extrapolated. The  $F_{min}$  values are based on a set of 16 noise figure measurements made at 16 different impedances using an ATN NP5 test system. From these measurements  $F_{min}$  is calculated. Refer to the noise parameter application section for more information.
- S and noise parameters are measured on a microstrip line made on 0.025 inch thick alumina carrier. The input reference plane is at the end of the gate lead. The output reference plane is at the end of the drain lead. The parameters include the effect of four plated through via holes connecting source landing pads on top of the test carrier to the microstrip ground plane on the bottom side of the carrier. Two 0.020 inch diameter via holes are placed within 0.010 inch from each source lead contact point, one via on each side of that point.

**ATF-55143 Typical Scattering Parameters,  $V_{DS} = 2V, I_{DS} = 15\text{ mA}$**

Freq. GHz	$S_{11}$			$S_{21}$			$S_{12}$			$S_{22}$			MSG/MAG dB
	Mag.	Ang.	dB	Mag.	Ang.	Mag.	Ang.	Mag.	Ang.	Mag.	Ang.		
0.1	0.997	-7.1	22.33	13.074	174.4	0.006	85.7	0.752	-4.6	33.38			
0.5	0.953	-34.5	21.82	12.333	153.0	0.027	69.4	0.712	-22.1	26.60			
0.9	0.873	-58.8	20.86	11.042	134.4	0.044	56.3	0.654	-36.7	24.00			
1.0	0.856	-64.6	20.58	10.693	130.3	0.047	53.3	0.636	-39.6	23.57			
1.5	0.759	-89.3	19.14	9.059	112.2	0.060	41.6	0.560	-51.8	21.79			
1.9	0.695	-106.2	18.06	7.998	100.0	0.068	34.4	0.509	-59.0	20.70			
2.0	0.681	-110.2	17.8	7.762	97.2	0.070	32.8	0.498	-60.5	20.45			
2.5	0.621	-129.3	16.62	6.773	83.9	0.076	25.6	0.443	-67.5	19.50			
3.0	0.578	-147.4	15.54	5.985	71.8	0.082	19.4	0.390	-73.6	18.63			
4.0	0.536	177.3	13.71	4.850	49.4	0.091	7.9	0.295	-87.3	17.27			
5.0	0.541	145.1	12.09	4.020	28.4	0.096	-3.0	0.225	-104.3	16.22			
6.0	0.554	119.1	10.59	3.384	9.0	0.101	-12.7	0.183	-120.8	13.89			
7.0	0.574	97.0	9.3	2.917	-9.1	0.105	-23.0	0.150	-138.4	12.18			
8.0	0.594	75.5	8.13	2.549	-27.0	0.106	-33.1	0.101	-149.7	10.73			
9.0	0.63	55.9	7.12	2.271	-44.6	0.113	-40.4	0.047	-175.2	9.87			
10.0	0.703	37.3	6.14	2.028	-63.5	0.121	-53.2	0.078	82.0	9.69			
11.0	0.757	21.1	4.92	1.762	-81.7	0.123	-65.3	0.162	51.1	9.12			
12.0	0.793	7.1	3.79	1.547	-98.5	0.125	-76.9	0.231	31.3	8.52			
13.0	0.818	-8.2	2.77	1.376	-115.9	0.125	-89.5	0.275	12.8	7.92			
14.0	0.841	-23.8	1.76	1.225	-134.3	0.125	-102.7	0.339	-5.5	7.38			
15.0	0.863	-38.1	0.32	1.038	-152.5	0.118	-116.3	0.438	-21.0	6.54			
16.0	0.856	-51.2	-1.29	0.862	-168.8	0.111	-128.0	0.524	-32.0	4.99			
17.0	0.871	-60.2	-2.66	0.736	177.0	0.109	-138.6	0.586	-44.4	4.38			
18.0	0.913	-70.4	-3.8	0.646	161.7	0.105	-151.9	0.636	-58.1	5.20			

**Typical Noise Parameters,  $V_{DS} = 2V, I_{DS} = 15\text{ mA}$**

Freq GHz	$F_{min}$ dB	$\Gamma_{opt}$ Mag.	$\Gamma_{opt}$ Ang.	$R_{n/50}$	$G_a$ dB
0.5	0.21	0.627	18.7	0.1	25.41
0.9	0.25	0.56	23.6	0.1	23.47
1.0	0.26	0.53	27.3	0.1	23.02
1.9	0.4	0.51	49.7	0.09	19.44
2.0	0.41	0.5	52.6	0.09	19.09
2.4	0.48	0.41	62.3	0.09	17.81
3.0	0.57	0.35	80.4	0.08	16.17
3.9	0.7	0.22	118.4	0.06	14.25
5.0	0.86	0.2	-176.5	0.06	12.6
5.8	0.99	0.23	-140.5	0.08	11.77
6.0	1.03	0.23	-134.6	0.08	11.6
7.0	1.16	0.29	-99.3	0.14	10.86
8.0	1.35	0.35	-69.3	0.25	10.22
9.0	1.49	0.43	-47.9	0.39	9.48
10.0	1.62	0.54	-30.8	0.57	8.47



**Figure 27. MSG/MAG and  $|S_{21}|^2$  vs. Frequency at 2V, 15 mA.**

**Notes:**

- $F_{min}$  values at 2 GHz and higher are based on measurements while the  $F_{min}$  below 2 GHz have been extrapolated. The  $F_{min}$  values are based on a set of 16 noise figure measurements made at 16 different impedances using an ATN NP5 test system. From these measurements a true  $F_{min}$  is calculated. Refer to the noise parameter application section for more information.
- S and noise parameters are measured on a microstrip line made on 0.025 inch thick alumina carrier. The input reference plane is at the end of the gate lead. The output reference plane is at the end of the drain lead. The parameters include the effect of four plated through via holes connecting source landing pads on top of the test carrier to the microstrip ground plane on the bottom side of the carrier. Two 0.020 inch diameter via holes are placed within 0.010 inch from each source lead contact point, one via on each side of that point.

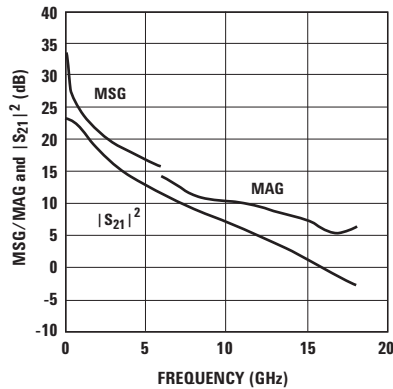


**ATF-55143 Typical Scattering Parameters,  $V_{DS} = 2V, I_{DS} = 20\text{ mA}$**

Freq. GHz	$S_{11}$			$S_{21}$			$S_{12}$			$S_{22}$			MSG/MAG dB
	Mag.	Ang.	dB	Mag.	Ang.	Mag.	Ang.	Mag.	Ang.	Mag.	Ang.		
0.1	0.997	-7.5	23.23	14.512	174.2	0.006	85.5	0.722	-4.8	33.84			
0.5	0.947	-36.2	22.66	13.582	151.8	0.026	69	0.679	-22.9	27.18			
0.9	0.858	-61.3	21.59	12.011	132.8	0.041	56	0.618	-37.7	24.67			
1.0	0.839	-67.2	21.29	11.602	128.6	0.044	53.2	0.599	-40.6	24.21			
1.5	0.738	-92.4	19.74	9.703	110.4	0.056	42.1	0.523	-52.5	22.39			
1.9	0.673	-109.4	18.59	8.5	98.3	0.063	35.5	0.474	-59.3	21.30			
2.0	0.659	-113.5	18.32	8.238	95.5	0.065	34	0.463	-60.7	21.03			
2.5	0.599	-132.6	17.07	7.135	82.4	0.071	27.5	0.411	-67.1	20.02			
3.0	0.558	-150.6	15.95	6.272	70.5	0.077	21.8	0.361	-72.7	19.11			
4.0	0.521	174.4	14.06	5.047	48.5	0.086	11.1	0.272	-85.6	17.69			
5.0	0.531	142.8	12.40	4.171	28	0.093	0.7	0.205	-102.3	16.52			
6.0	0.546	117.4	10.89	3.505	8.9	0.099	-9	0.166	-118.7	13.92			
7.0	0.568	95.6	9.60	3.021	-9	0.104	-19.4	0.134	-136.5	12.35			
8.0	0.588	74.4	8.42	2.637	-26.7	0.106	-29.8	0.086	-146.2	10.93			
9.0	0.625	55.2	7.41	2.348	-44.1	0.115	-37.5	0.032	-171.2	10.11			
10.0	0.699	36.8	6.43	2.097	-62.9	0.123	-50.7	0.077	71.3	9.93			
11.0	0.754	20.9	5.21	1.823	-80.9	0.125	-63.2	0.165	46	9.35			
12.0	0.791	6.9	4.08	1.60	-97.5	0.127	-75.1	0.235	27.6	8.75			
13.0	0.818	-8.2	3.07	1.424	-114.7	0.128	-87.8	0.278	9.8	8.22			
14.0	0.839	-23.8	2.07	1.269	-133.1	0.127	-101.4	0.340	-8.1	7.60			
15.0	0.864	-38.1	0.65	1.078	-151	0.12	-114.9	0.440	-22.8	6.84			
16.0	0.858	-51.1	-0.95	0.896	-167.3	0.113	-126.8	0.523	-33.4	5.28			
17.0	0.873	-60.2	-2.30	0.768	178.6	0.111	-137.5	0.583	-45.6	4.68			
18.0	0.917	-70.4	-3.41	0.675	163.4	0.106	-150.9	0.632	-59	5.62			

**Typical Noise Parameters,  $V_{DS} = 2V, I_{DS} = 20\text{ mA}$**

Freq GHz	$F_{min}$ dB	$\Gamma_{opt}$ Mag.	$\Gamma_{opt}$ Ang.	$R_{n/50}$	$G_a$ dB
0.5	0.21	0.63	18.4	0.1	25.67
0.9	0.25	0.54	24.4	0.09	23.78
1.0	0.26	0.53	28.8	0.09	23.34
1.9	0.39	0.49	50.6	0.09	19.84
2.0	0.4	0.47	52.8	0.09	19.5
2.4	0.48	0.38	63.6	0.08	18.24
3.0	0.56	0.32	82	0.07	16.61
3.9	0.69	0.2	125.1	0.06	14.67
5.0	0.85	0.2	-167.2	0.06	12.97
5.8	0.98	0.24	-133.4	0.08	12.09
6.0	1.02	0.24	-128.4	0.09	10.89
7.0	1.16	0.3	-94.8	0.15	11.12
8.0	1.34	0.36	-66.4	0.25	10.45
9.0	1.49	0.45	-45.7	0.4	9.73
10.0	1.62	0.55	-28.6	0.6	8.8



**Figure 28. MSG/MAG and  $|S_{21}|^2$  vs. Frequency at 2V, 20 mA.**

Notes:

- $F_{min}$  values at 2 GHz and higher are based on measurements while the  $F_{min}$ s below 2 GHz have been extrapolated. The  $F_{min}$  values are based on a set of 16 noise figure measurements made at 16 different impedances using an ATN NP5 test system. From these measurements a true  $F_{min}$  is calculated. Refer to the noise parameter application section for more information.
- S and noise parameters are measured on a microstrip line made on 0.025 inch thick alumina carrier. The input reference plane is at the end of the gate lead. The output reference plane is at the end of the drain lead. The parameters include the effect of four plated through via holes connecting source landing pads on top of the test carrier to the microstrip ground plane on the bottom side of the carrier. Two 0.020 inch diameter via holes are placed within 0.010 inch from each source lead contact point, one via on each side of that point.

**ATF-55143 Typical Scattering Parameters,  $V_{DS} = 2.7V, I_{DS} = 10\text{ mA}$**

Freq. GHz	$S_{11}$			$S_{21}$			$S_{12}$			$S_{22}$			MSG/MAG dB
	Mag.	Ang.	dB	Mag.	Ang.	Mag.	Ang.	Mag.	Ang.	Mag.	Ang.		
0.1	0.998	-6.4	20.86	11.044	174.9	0.006	86.2	0.819	-3.9	32.65			
0.5	0.963	-31.2	20.46	10.549	155	0.026	70.4	0.786	-19.1	26.08			
0.9	0.896	-53.8	19.68	9.641	137.5	0.043	57.3	0.737	-32	23.51			
1.0	0.881	-59.2	19.44	9.376	133.4	0.047	54.4	0.72	-34.7	23.00			
1.5	0.794	-83	18.21	8.133	115.6	0.06	42.2	0.651	-46	21.32			
1.9	0.732	-99.5	17.25	7.284	103.3	0.068	34.4	0.602	-52.9	20.30			
2.0	0.718	-103.4	17.01	7.087	100.6	0.07	32.6	0.592	-54.5	20.05			
2.5	0.655	-122.3	15.94	6.267	87.1	0.076	24.8	0.538	-61.3	19.16			
3.0	0.608	-140.2	14.96	5.599	74.8	0.082	17.9	0.485	-67.3	18.34			
4.0	0.553	-175.9	13.28	4.615	51.7	0.089	5.6	0.39	-80.1	17.15			
5.0	0.548	150.9	11.74	3.862	30.2	0.092	-5.4	0.321	-94.7	16.23			
6.0	0.556	123.9	10.30	3.272	10.3	0.094	-14.6	0.280	-109	14.17			
7.0	0.573	100.9	9.04	2.83	-8.3	0.096	-23.9	0.247	-124.1	12.29			
8.0	0.590	78.6	7.89	2.481	-26.5	0.096	-32.8	0.204	-134.3	10.78			
9.0	0.625	58.4	6.94	2.224	-44.3	0.102	-38	0.152	-146.7	9.94			
10.0	0.699	39.2	6.03	2.002	-63.6	0.112	-49.7	0.098	166.8	9.89			
11.0	0.752	22.7	4.89	1.755	-82.3	0.115	-61.1	0.112	100	9.34			
12.0	0.789	8.4	3.78	1.546	-99.8	0.12	-72.4	0.167	62.3	8.81			
13.0	0.815	-7	2.78	1.378	-117.8	0.122	-84.7	0.211	37	8.23			
14.0	0.838	-22.8	1.81	1.231	-137	0.124	-98.3	0.274	12.6	7.69			
15.0	0.862	-37.2	0.37	1.044	-155.9	0.119	-111.8	0.387	-7.6	6.82			
16.0	0.856	-50.5	-1.27	0.864	-173.3	0.113	-124.4	0.491	-21.5	5.15			
17.0	0.872	-59.7	-2.73	0.730	171.9	0.111	-135.6	0.568	-35.9	5.54			
18.0	0.915	-70	-3.96	0.634	156	0.107	-149.4	0.628	-51.2	5.68			

**Typical Noise Parameters,  $V_{DS} = 2.7V, I_{DS} = 10\text{ mA}$**

Freq GHz	$F_{min}$ dB	$\Gamma_{opt}$ Mag.	$\Gamma_{opt}$ Ang.	$R_{n/50}$	$G_a$ dB
0.5	0.2	0.64	19	0.12	25.29
0.9	0.26	0.59	22.7	0.12	23.24
1.0	0.27	0.54	26	0.12	22.76
1.9	0.39	0.54	48.3	0.11	19.01
2.0	0.4	0.54	49.9	0.11	18.66
2.4	0.48	0.45	59.8	0.1	17.35
3.0	0.57	0.39	75.6	0.09	15.69
3.9	0.72	0.26	108.7	0.07	13.79
5.0	0.88	0.2	167.5	0.06	12.26
5.8	1.02	0.22	-154.8	0.07	11.52
6.0	1.04	0.21	-147.8	0.08	11.37
7.0	1.19	0.26	-107.9	0.13	10.76
8.0	1.39	0.32	-75	0.23	10.2
9.0	1.54	0.41	-51.6	0.36	9.48
10.0	1.65	0.53	-33.6	0.54	8.38

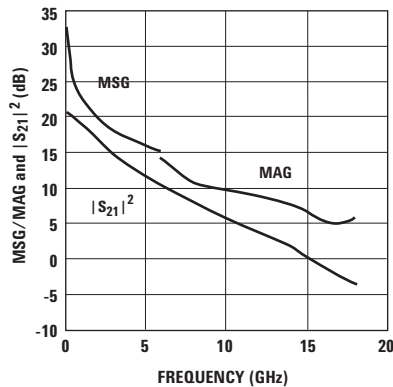


Figure 29. MSG/MAG and  $|S_{21}|^2$  vs. Frequency at 2.7V, 10 mA.

Notes:

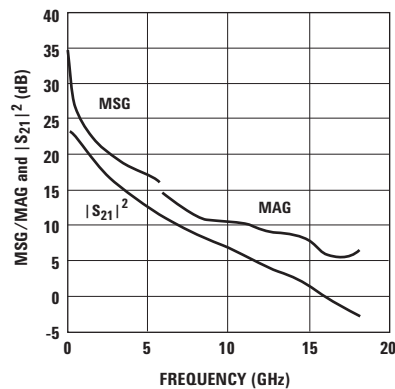
- $F_{min}$  values at 2 GHz and higher are based on measurements while the  $F_{min}$  below 2 GHz have been extrapolated. The  $F_{min}$  values are based on a set of 16 noise figure measurements made at 16 different impedances using an ATN NP5 test system. From these measurements a true  $F_{min}$  is calculated. Refer to the noise parameter application section for more information.
- S and noise parameters are measured on a microstrip line made on 0.025 inch thick alumina carrier. The input reference plane is at the end of the gate lead. The output reference plane is at the end of the drain lead. The parameters include the effect of four plated through via holes connecting source landing pads on top of the test carrier to the microstrip ground plane on the bottom side of the carrier. Two 0.020 inch diameter via holes are placed within 0.010 inch from each source lead contact point, one via on each side of that point.

**ATF-55143 Typical Scattering Parameters,  $V_{DS} = 2.7V$ ,  $I_{DS} = 20\text{ mA}$**

Freq. GHz	$S_{11}$			$S_{21}$			$S_{12}$			$S_{22}$		
	Mag.	Ang.	dB	Mag.	Ang.	dB	Mag.	Ang.	dB	Mag.	Ang.	dB
0.1	0.997	-7.4	23.29	14.603	174.2		0.005	85.8		0.755	-4.4	34.65
0.5	0.947	-35.8	22.72	13.682	152		0.024	69.2		0.713	-21.1	27.56
0.9	0.860	-60.8	21.67	12.116	133		0.038	56.2		0.652	-34.6	25.04
1.0	0.840	-66.6	21.37	11.705	128.8		0.041	53.4		0.633	-37.3	24.56
1.5	0.739	-91.7	19.83	9.802	110.6		0.051	42.4		0.56	-48	22.84
1.9	0.672	-108.6	18.68	8.587	98.5		0.057	36		0.513	-54	21.78
2.0	0.658	-112.7	18.41	8.323	95.8		0.059	34.5		0.503	-55.3	21.49
2.5	0.597	-131.7	17.16	7.21	82.7		0.065	28.4		0.455	-60.9	20.45
3.0	0.554	-149.7	16.04	6.341	70.9		0.069	23		0.409	-65.7	19.63
4.0	0.515	175.4	14.17	5.114	49.1		0.078	13.3		0.328	-76.7	18.17
5.0	0.523	143.7	12.55	4.239	28.6		0.084	3.7		0.267	-90.7	17.03
6.0	0.538	118.2	11.06	3.572	9.6		0.09	-5		0.232	-104.8	14.23
7.0	0.559	96.4	9.78	3.084	-8.4		0.095	-14.7		0.201	-119.6	12.69
8.0	0.579	75.2	8.62	2.699	-25.9		0.098	-24.2		0.162	-127.4	11.32
9.0	0.615	56	7.65	2.413	-43.3		0.107	-31		0.113	-136.5	10.53
10.0	0.690	37.7	6.73	2.171	-62.1		0.117	-44		0.055	160.9	10.46
11.0	0.748	21.7	5.57	1.9	-80.3		0.122	-56.4		0.096	75.9	10.01
12.0	0.787	7.9	4.48	1.675	-97.3		0.126	-68.5		0.164	45.5	9.48
13.0	0.816	-7.3	3.5	1.496	-114.9		0.128	-81.4		0.210	23.7	9.02
14.0	0.841	-22.9	2.55	1.341	-133.5		0.13	-95.1		0.277	3	8.56
15.0	0.867	-37.3	1.15	1.142	-152.1		0.124	-109.2		0.386	-14.3	7.65
16.0	0.862	-50.5	-0.44	0.95	-169		0.118	-121.9		0.483	-26.3	5.86
17.0	0.877	-59.7	-1.83	0.81	176.3		0.116	-133.3		0.555	-39.5	5.25
18.0	0.921	-70	-2.99	0.709	160.6		0.111	-147.1		0.612	-53.9	6.59

**Typical Noise Parameters,  $V_{DS} = 2.7V$ ,  $I_{DS} = 20\text{ mA}$**

Freq GHz	$F_{min}$ dB	$\Gamma_{opt}$ Mag.	$\Gamma_{opt}$ Ang.	$R_{n/50}$	$G_a$ dB
0.5	0.20	0.65	17.6	0.1	25.79
0.9	0.25	0.55	23.6	0.1	23.9
1.0	0.26	0.53	28.3	0.1	23.45
1.9	0.39	0.49	49	0.09	19.94
2.0	0.4	0.48	51.5	0.09	19.6
2.4	0.47	0.38	62	0.08	18.34
3.0	0.56	0.32	79.6	0.07	16.71
3.9	0.69	0.19	120	0.06	14.8
5.0	0.85	0.18	-168.8	0.06	13.14
5.8	0.98	0.22	-135.4	0.08	12.3
6.0	1.01	0.22	-128.7	0.09	12.12
7.0	1.15	0.29	-94.6	0.15	11.38
8.0	1.32	0.35	-66.7	0.25	10.74
9.0	1.47	0.44	-45.7	0.38	10.04
10.0	1.58	0.54	-28.6	0.57	9.1



**Figure 30. MSG/MAG and  $|S_{21}|^2$  vs. Frequency at 2.7V, 20 mA.**

Notes:

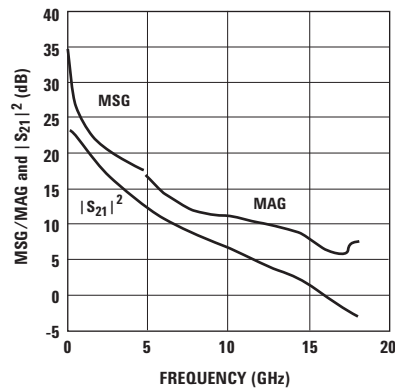
- $F_{min}$  values at 2 GHz and higher are based on measurements while the  $F_{min}$ s below 2 GHz have been extrapolated. The  $F_{min}$  values are based on a set of 16 noise figure measurements made at 16 different impedances using an ATN NP5 test system. From these measurements a true  $F_{min}$  is calculated. Refer to the noise parameter application section for more information.
- S and noise parameters are measured on a microstrip line made on 0.025 inch thick alumina carrier. The input reference plane is at the end of the gate lead. The output reference plane is at the end of the drain lead. The parameters include the effect of four plated through via holes connecting source landing pads on top of the test carrier to the microstrip ground plane on the bottom side of the carrier. Two 0.020 inch diameter via holes are placed within 0.010 inch from each source lead contact point, one via on each side of that point.

**ATF-55143 Typical Scattering Parameters,  $V_{DS} = 3V, I_{DS} = 20\text{ mA}$**

Freq. GHz	$S_{11}$			$S_{21}$			$S_{12}$			$S_{22}$			MSG/MAG dB
	Mag.	Ang.	dB	Mag.	Ang.	Mag.	Ang.	Mag.	Ang.	Mag.	Ang.		
0.1	0.998	-7.4	23.34	14.697	174.2	0.005	85.1	0.763	-4.3	34.68			
0.5	0.947	-35.9	22.77	13.762	151.9	0.023	69.2	0.721	-20.6	27.77			
0.9	0.859	-60.9	21.71	12.178	132.9	0.037	56.2	0.661	-33.8	25.17			
1.0	0.839	-66.7	21.41	11.764	128.7	0.039	53.5	0.642	-36.3	24.79			
1.5	0.738	-91.8	19.86	9.844	110.5	0.050	42.5	0.570	-46.7	22.94			
1.9	0.671	-108.7	18.71	8.621	98.5	0.055	36.2	0.524	-52.5	21.95			
2.0	0.657	-112.7	18.44	8.354	95.7	0.057	34.8	0.514	-53.7	21.66			
2.5	0.595	-131.7	17.19	7.233	82.7	0.062	28.7	0.468	-59.1	20.67			
3.0	0.552	-149.8	16.07	6.36	70.9	0.067	23.5	0.423	-63.8	19.77			
4.0	0.513	175.4	14.2	5.13	49.1	0.075	14.2	0.345	-74.3	18.35			
5.0	0.521	143.8	12.58	4.256	28.7	0.081	4.9	0.287	-87.7	16.82			
6.0	0.536	118.3	11.1	3.588	9.7	0.087	-3.5	0.254	-101.6	14.32			
7.0	0.557	96.5	9.83	3.1	-8.2	0.092	-12.9	0.224	-116.1	12.80			
8.0	0.577	75.3	8.67	2.715	-25.8	0.095	-22.1	0.187	-124.3	11.44			
9.0	0.613	56.2	7.71	2.43	-43.1	0.105	-28.7	0.140	-133.5	10.68			
10.0	0.687	38	6.81	2.192	-61.8	0.116	-41.7	0.075	-178.8	10.67			
11.0	0.746	22	5.67	1.922	-80.2	0.121	-54	0.084	94	10.24			
12.0	0.787	8.1	4.59	1.697	-97.2	0.126	-66.1	0.145	54.4	9.82			
13.0	0.816	-7	3.62	1.516	-114.9	0.128	-79.1	0.191	30	9.35			
14.0	0.842	-22.6	2.67	1.36	-133.6	0.131	-93	0.256	8	9.01			
15.0	0.869	-37	1.3	1.161	-152.3	0.126	-107.2	0.369	-10.9	8.04			
16.0	0.863	-50.2	-0.29	0.967	-169.6	0.1200	-120.2	0.471	-23.5	6.10			
17.0	0.879	-59.6	-1.7	0.822	175.6	0.118	-131.9	0.548	-37.3	5.47			
18.0	0.924	-69.8	-2.87	0.719	159.7	0.113	-145.9	0.608	-52.2	7.40			

**Typical Noise Parameters,  $V_{DS} = 3V, I_{DS} = 20\text{ mA}$**

Freq GHz	$F_{min}$ dB	$\Gamma_{opt}$ Mag.	$\Gamma_{opt}$ Ang.	$R_{n/50}$	$G_a$ dB
0.5	0.18	0.63	17.6	0.1	25.89
0.9	0.24	0.54	23.4	0.1	23.98
1.0	0.25	0.53	27.9	0.1	23.53
1.9	0.39	0.48	48.4	0.09	20
2.0	0.4	0.47	51.6	0.09	19.66
2.4	0.47	0.39	61.9	0.08	18.4
3.0	0.56	0.32	78.7	0.07	16.77
3.9	0.68	0.19	119.8	0.06	14.85
5.0	0.85	0.19	-170.4	0.06	13.21
5.8	0.97	0.22	-135.1	0.08	12.37
6.0	1.01	0.22	-128.4	0.09	12.2
7.0	1.14	0.28	-94.7	0.14	11.47
8.0	1.31	0.35	-66.8	0.25	10.84
9.0	1.47	0.44	-45.6	0.38	10.15
10.0	1.59	0.54	-28.9	0.57	9.22



**Figure 31. MSG/MAG and  $|S_{21}|^2$  vs. Frequency at 3V, 20 mA.**

**Notes:**

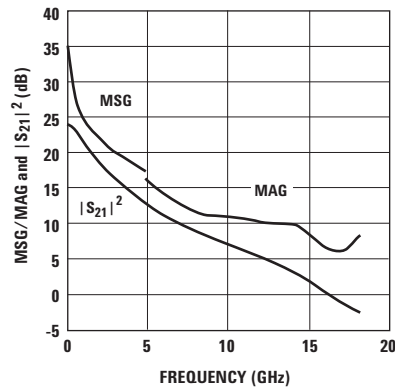
- $F_{min}$  values at 2 GHz and higher are based on measurements while the  $F_{min}$ s below 2 GHz have been extrapolated. The  $F_{min}$  values are based on a set of 16 noise figure measurements made at 16 different impedances using an ATN NP5 test system. From these measurements a true  $F_{min}$  is calculated. Refer to the noise parameter application section for more information.
- S and noise parameters are measured on a microstrip line made on 0.025 inch thick alumina carrier. The input reference plane is at the end of the gate lead. The output reference plane is at the end of the drain lead. The parameters include the effect of four plated through via holes connecting source landing pads on top of the test carrier to the microstrip ground plane on the bottom side of the carrier. Two 0.020 inch diameter via holes are placed within 0.010 inch from each source lead contact point, one via on each side of that point.

**ATF-55143 Typical Scattering Parameters,  $V_{DS} = 3V, I_{DS} = 30\text{ mA}$**

Freq. GHz	$S_{11}$			$S_{21}$		$S_{12}$		$S_{22}$		MSG/MAG dB
	Mag.	Ang.	dB	Mag.	Ang.	Mag.	Ang.	Mag.	Ang.	
0.1	0.996	-7.9	24.3	16.407	173.9	0.005	85.6	0.729	-4.5	35.16
0.5	0.937	-38.1	23.64	15.205	150.4	0.021	68.8	0.683	-21.2	28.60
0.9	0.840	-64.1	22.44	13.246	130.9	0.034	56.1	0.620	-34.3	25.91
1.0	0.819	-70.1	22.11	12.753	126.6	0.036	53.5	0.601	-36.8	25.49
1.5	0.712	-95.7	20.43	10.507	108.4	0.046	43.4	0.531	-46.5	23.59
1.9	0.646	-112.8	19.2	9.117	96.4	0.051	37.7	0.488	-51.8	22.52
2.0	0.631	-116.8	18.91	8.823	93.7	0.052	36.6	0.479	-52.9	22.30
2.5	0.571	-135.8	17.59	7.578	80.9	0.057	31.3	0.437	-57.7	21.24
3.0	0.531	-153.9	16.42	6.625	69.4	0.062	26.6	0.398	-61.8	20.29
4.0	0.499	171.8	14.49	5.303	48.1	0.071	18.1	0.328	-71.6	18.73
5.0	0.512	140.9	12.84	4.386	28.1	0.078	9.2	0.273	-84.7	16.32
6.0	0.529	116	11.35	3.693	9.4	0.085	0.7	0.242	-98.5	14.36
7.0	0.552	94.7	10.07	3.188	-8.3	0.092	-9	0.214	-112.9	12.98
8.0	0.573	73.9	8.91	2.79	-25.6	0.096	-18.6	0.179	-120.5	11.65
9.0	0.609	55.1	7.94	2.496	-42.7	0.107	-25.8	0.134	-128.4	10.92
10.0	0.684	37.3	7.05	2.251	-61.3	0.118	-39.2	0.064	-173.3	10.93
11.0	0.744	21.6	5.91	1.975	-79.5	0.123	-51.9	0.075	87.5	10.53
12.0	0.786	7.9	4.83	1.744	-96.4	0.128	-64.3	0.141	49.7	10.16
13.0	0.816	-7.2	3.86	1.56	-113.9	0.131	-77.5	0.187	26.4	9.84
14.0	0.842	-22.8	2.93	1.401	-132.6	0.133	-91.7	0.250	5.1	9.51
15.0	0.870	-37.1	1.56	1.197	-151.1	0.128	-106	0.367	-12.6	8.39
16.0	0.866	-50.3	-0.01	0.998	-168.2	0.122	-119.1	0.467	-24.8	6.39
17.0	0.882	-59.7	-1.4	0.851	177	0.12	-130.8	0.543	-38.2	5.77
18.0	0.927	-69.9	-2.55	0.746	161.2	0.115	-144.8	0.602	-52.8	8.12

**Typical Noise Parameters,  $V_{DS} = 3V, I_{DS} = 30\text{ mA}$**

Freq GHz	$F_{min}$ dB	$\Gamma_{opt}$ Mag.	$\Gamma_{opt}$ Ang.	$R_{n/50}$	$G_a$ dB
0.5	0.19	0.59	18.4	0.09	26.27
0.9	0.25	0.5	25.5	0.09	24.41
1.0	0.26	0.52	30.7	0.09	23.98
1.9	0.41	0.44	50.6	0.08	20.51
2.0	0.42	0.43	54.5	0.08	20.18
2.4	0.49	0.34	65.1	0.08	18.92
3.0	0.59	0.27	84.7	0.07	17.28
3.9	0.72	0.17	132.6	0.06	15.33
5.0	0.88	0.19	-156.2	0.06	13.61
5.8	1.02	0.24	-125.3	0.09	12.71
6.0	1.06	0.25	-118.8	0.1	12.52
7.0	1.2	0.32	-88.8	0.17	11.73
8.0	1.37	0.39	-62.7	0.28	11.08
9.0	1.53	0.47	-43.1	0.43	10.41
10.0	1.66	0.57	-27	0.65	9.58



**Figure 32. MSG/MAG and  $|S_{21}|^2$  vs. Frequency at 3V, 30 mA.**

**Notes:**

- $F_{min}$  values at 2 GHz and higher are based on measurements while the  $F_{min}$ s below 2 GHz have been extrapolated. The  $F_{min}$  values are based on a set of 16 noise figure measurements made at 16 different impedances using an ATN NP5 test system. From these measurements a true  $F_{min}$  is calculated. Refer to the noise parameter application section for more information.
- S and noise parameters are measured on a microstrip line made on 0.025 inch thick alumina carrier. The input reference plane is at the end of the gate lead. The output reference plane is at the end of the drain lead. The parameters include the effect of four plated through via holes connecting source landing pads on top of the test carrier to the microstrip ground plane on the bottom side of the carrier. Two 0.020 inch diameter via holes are placed within 0.010 inch from each source lead contact point, one via on each side of that point.

## ATF-55143 Applications Information

### Introduction

Avago Technologies' ATF-55143 is a low noise enhancement mode PHEMT designed for use in low cost commercial applications in the VHF through 6 GHz frequency range. As opposed to a typical depletion mode PHEMT where the gate must be made negative with respect to the source for proper operation, an enhancement mode PHEMT requires that the gate be made more positive than the source for normal operation. Therefore a negative power supply voltage is not required for an enhancement mode device. Biasing an enhancement mode PHEMT is much like biasing the typical bipolar junction transistor. Instead of a 0.7V base to emitter voltage, the ATF-55143 enhancement mode PHEMT requires about a 0.47V potential between the gate and source for a nominal drain current of 10 mA.

### Matching Networks

The techniques for impedance matching an enhancement mode device are very similar to those for matching a depletion mode device. The only difference is in the method of supplying gate bias. S and Noise Parameters for various bias conditions are listed in this data sheet. The circuit shown in Figure 33 shows a typical LNA circuit normally used for 900 and 1900 MHz applications (Consult the Avago Technologies website for application notes covering specific applications). High pass impedance matching networks consisting of L1/C1 and L4/C4 provide the appropriate match for noise figure, gain, S11 and S22. The high pass structure also provides low frequency gain reduction which can be beneficial from the standpoint of improving out-of-band rejection.

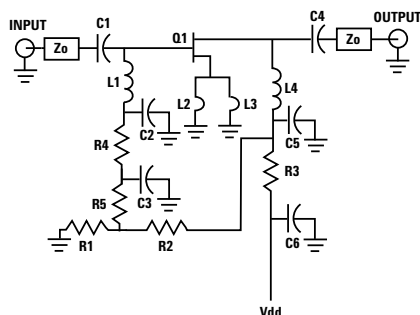


Figure 33. Typical ATF-55143 LNA with Passive Biasing.

Capacitors C2 and C5 provide a low impedance in-band RF bypass for the matching networks. Resistors R3 and R4 provide a very important low frequency termination for the device. The resistive termination improves low frequency stability. Capacitors C3 and C6 provide the low frequency RF bypass for resistors R3 and R4. Their value should be chosen carefully as C3 and C6 also provide a termination for low frequency mixing products. These mixing products are as a result of two or more in-

band signals mixing and producing third order in-band distortion products. The low frequency or difference mixing products are terminated by C3 and C6. For best suppression of third order distortion products based on the CDMA 1.25 MHz signal spacing, C3 and C6 should be 0.1  $\mu$ F in value. Smaller values of capacitance will not suppress the generation of the 1.25 MHz difference signal and as a result will show up as poorer two tone IP3 results.

### Bias Networks

One of the major advantages of the enhancement mode technology is that it allows the designer to be able to dc ground the source leads and then merely apply a positive voltage on the gate to set the desired amount of quiescent drain current  $I_d$ .

Whereas a depletion mode PHEMT pulls maximum drain current when  $V_{gs} = 0V$ , an enhancement mode PHEMT pulls only a small amount of leakage current when  $V_{gs} = 0V$ . Only when  $V_{gs}$  is increased above  $V_{th}$ , the device threshold voltage, will drain current start to flow. At a  $V_{ds}$  of 2.7V and a nominal  $V_{gs}$  of 0.47V, the drain current  $I_d$  will be approximately 10 mA. The data sheet suggests a minimum and maximum  $V_{gs}$  over which the desired amount of drain current will be achieved. It is also important to note that if the gate terminal is left open circuited, the device will pull some amount of drain current due to leakage current creating a voltage differential between the gate and source terminals.

### Passive Biasing

Passive biasing of the ATF-55143 is accomplished by the use of a voltage divider consisting of R1 and R2. The voltage for the divider is derived from the drain voltage which provides a form of voltage feedback through the use of R3 to help keep drain current constant. Resistor R5 (approximately 10k $\Omega$ ) is added to limit the gate current of enhancement mode devices such as the ATF-55143. This is especially important when the device is driven to  $P_{1dB}$  or  $P_{SAT}$ .

Resistor R3 is calculated based on desired  $V_{ds}$ ,  $I_{ds}$  and available power supply voltage.

$$R3 = \frac{V_{DD} - V_{ds}}{I_{ds} + I_{BB}} \quad (1)$$

$V_{DD}$  is the power supply voltage.

$V_{ds}$  is the device drain to source voltage.

$I_{ds}$  is the desired drain current.

$I_{BB}$  is the current flowing through the R1/R2 resistor voltage divider network.

The values of resistors R1 and R2 are calculated with the following formulas

$$R1 = \frac{V_{gs}}{I_{BB}} \quad (2)$$

$$R2 = \frac{(V_{ds} - V_{gs}) R1}{V_{gs}} \quad (3)$$

### Example Circuit

$$\begin{aligned} V_{DD} &= 3V \\ V_{ds} &= 2.7V \\ I_{ds} &= 10 \text{ mA} \\ V_{gs} &= 0.47V \end{aligned}$$

Choose  $I_{BB}$  to be at least 10X the normal expected gate leakage current.  $I_{BB}$  was conservatively chosen to be 0.5 mA for this example. Using equations (1), (2), and (3) the resistors are calculated as follows

$$\begin{aligned} R1 &= 940\Omega \\ R2 &= 4460\Omega \\ R3 &= 28.6\Omega \end{aligned}$$

### Active Biasing

Active biasing provides a means of keeping the quiescent bias point constant over temperature and constant over lot to lot variations in device dc performance. The advantage of the active biasing of an enhancement mode PHEMT versus a depletion mode PHEMT is that a negative power source is not required. The techniques of active biasing an enhancement mode device are very similar to those used to bias a bipolar junction transistor.

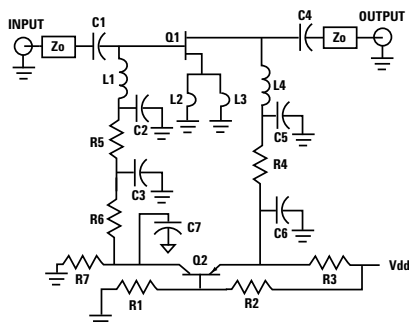


Figure 34. Typical ATF-55143 LNA with Active Biasing.

An active bias scheme is shown in Figure 34. R1 and R2 provide a constant voltage source at the base of a PNP transistor at Q2. The constant voltage at the base of Q2 is raised by 0.7 volts at the emitter. The constant emitter voltage plus the regulated  $V_{DD}$  supply are present across resistor R3. Constant voltage across R3 provides a constant current supply for the drain current. Resistors R1 and R2 are used to set the desired  $V_{ds}$ . The combined

series value of these resistors also sets the amount of extra current consumed by the bias network. The equations that describe the circuit's operation are as follows.

$$V_E = V_{ds} + (I_{ds} \cdot R4) \quad (1)$$

$$R3 = \frac{V_{DD} - V_E}{I_{ds}} \quad (2)$$

$$V_B = V_E - V_{BE} \quad (3)$$

$$V_B = \frac{R1}{R1 + R2} V_{DD} \quad (4)$$

$$V_{DD} = I_{BB} (R1 + R2) \quad (5)$$

Rearranging equation (4) provides the following formula

$$R2 = \frac{R1 (V_{DD} - V_B)}{V_B} \quad (4A)$$

and rearranging equation (5) provides the following formula

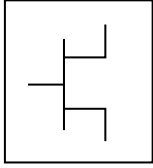
$$R1 = \frac{V_{DD}}{I_{BB} \left(1 + \frac{V_{DD} - V_B}{V_B}\right)} \quad (5A)$$

### Example Circuit

$$\begin{aligned} V_{DD} &= 3V & I_{BB} &= 0.5 \text{ mA} \\ V_{ds} &= 2.7V \\ I_{ds} &= 10 \text{ mA} \\ R4 &= 10\Omega \\ V_{BE} &= 0.7V \end{aligned}$$

Equation (1) calculates the required voltage at the emitter of the PNP transistor based on desired  $V_{ds}$  and  $I_{ds}$  through resistor R4 to be 2.8V. Equation (2) calculates the value of resistor R3 which determines the drain current  $I_{ds}$ . In the example  $R3=20\Omega$ . Equation (3) calculates the voltage required at the junction of resistors R1 and R2. This voltage plus the step-up of the base emitter junction determines the regulated  $V_{ds}$ . Equations (4) and (5) are solved simultaneously to determine the value of resistors R1 and R2. In the example  $R1=4200\Omega$  and  $R2=1800\Omega$ . R7 is chosen to be 1k $\Omega$ . This resistor keeps a small amount of current flowing through Q2 to help maintain bias stability. R6 is chosen to be 10k $\Omega$ . This value of resistance is necessary to limit Q1 gate current in the presence of high RF drive levels (especially when Q1 is driven to the  $P_{1dB}$  gain compression point). C7 provides a low frequency bypass to keep noise from Q2 effecting the operation of Q1. C7 is typically 0.1  $\mu$ F.

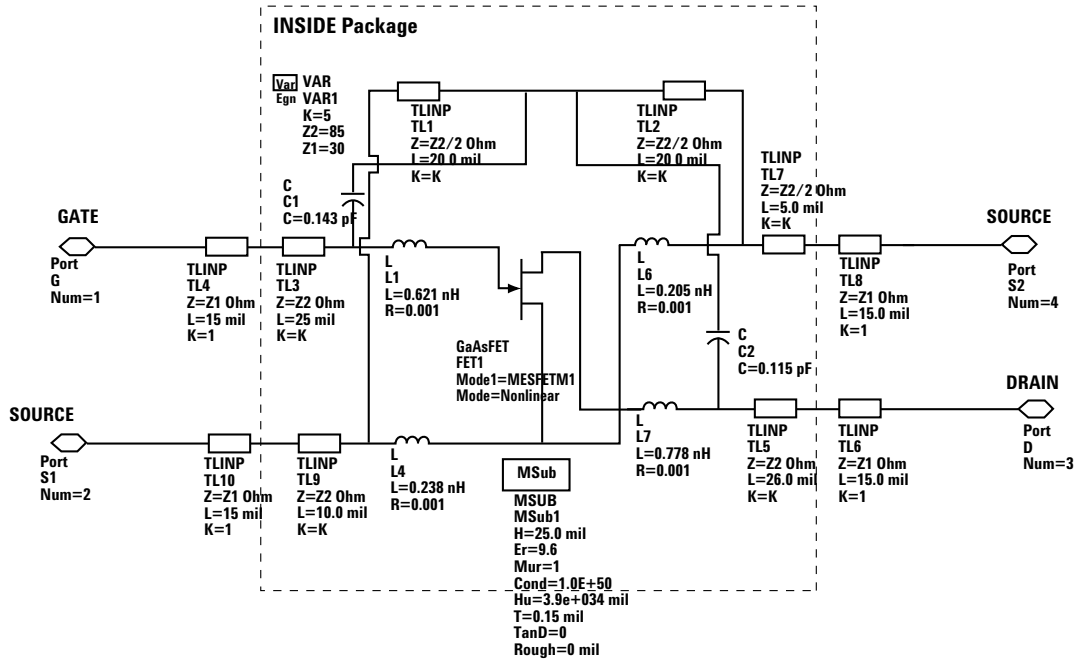
# ATF-55143 Die Model



Advanced\_Curtice2\_Model

MESFETM1  
 NFET=yes      Rf=      Crf=0.1 F      N=  
 PFET=no      Gscap=2      Gsfwd=      Fnc=1 MHz  
 Vto=0.3      Cgs=0.6193 pF      Gsrev=      R=0.08  
 Beta=0.444      Cgd=0.1435 pF      Gdfwd=      P=0.2  
 Lambda=72e-3      Gdcap=2      Gdrev=      C=0.1  
 Alpha=13      Fc=0.65      R1=      Taumdl=no  
 Tau=      Rgd=0.5 Ohm      R2=      wVgfwd=  
 Tnom=16.85      Rd=2.025 Ohm      Vbi=0.95      wBvgs=  
 Idstc=      Rg=1.7 Ohm      Vbr=      wBvgd=  
 Ucrit=-0.72      Rs=0.675 Ohm      Vjr=      wBvds=  
 Vgexp=1.91      Ld=      Is=      wldsmx=  
 Gamds=1e-4      Lg=0.094 nH      Ir=      wPmax=  
 Vtotc=      Ls=      lmax=      AllParams=  
 Betatce=      Cds=0.100 pF      Xti=  
 Rgs=0.5 Ohm      Rc=390 Ohm      Eg=

# ATF-55143 ADS Package Model





## Designing with S and Noise Parameters and the Non-Linear Model

The non-linear model describing the ATF-55143 includes both the die and associated package model. The package model includes the effect of the pins but does not include the effect of the additional source inductance associated with grounding the source leads through the printed circuit board. The device S and Noise Parameters do include the effect of 0.020 inch thickness printed circuit board vias. When comparing simulation results between the measured S parameters and the simulated non-linear model, be sure to include the effect of the printed circuit board to get an accurate comparison. This is shown schematically in Figure 35.

## For Further Information

The information presented here is an introduction to the use of the ATF-55143 enhancement mode PHEMT. More detailed application circuit information is available from Avago Technologies. Consult the web page or your local Avago Technologies sales representative.

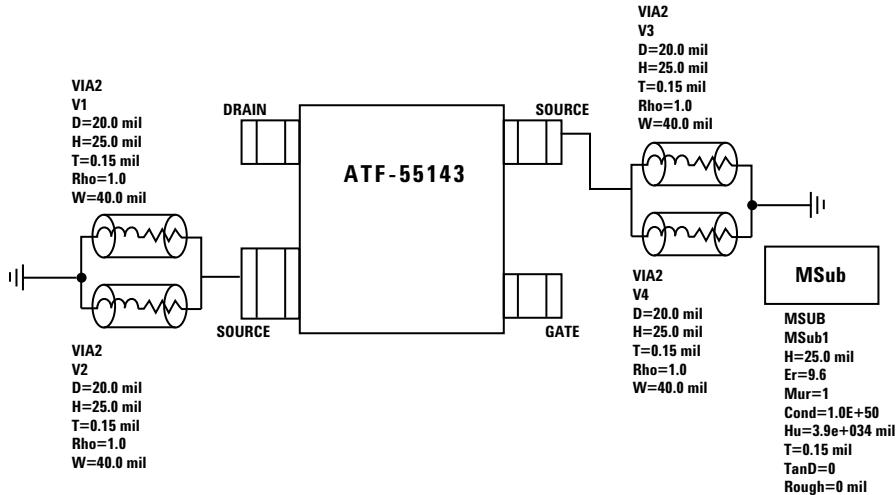


Figure 35. Adding Vias to the ATF-55143 Non-Linear Model for Comparison to Measured S and Noise Parameters.

## Noise Parameter Applications Information

$F_{min}$  values at 2 GHz and higher are based on measurements while the  $F_{min}$  below 2 GHz have been extrapolated. The  $F_{min}$  values are based on a set of 16 noise figure measurements made at 16 different impedances using an ATN NP5 test system. From these measurements, a true  $F_{min}$  is calculated.  $F_{min}$  represents the true minimum noise figure of the device when the device is presented with an impedance matching network that transforms the source impedance, typically  $50\Omega$ , to an impedance represented by the reflection coefficient  $\Gamma_o$ . The designer must design a matching network that will present  $\Gamma_o$  to the device with minimal associated circuit losses. The noise figure of the completed amplifier is equal to the noise figure of the device plus the losses of the matching network preceding the device. The noise figure of the device is equal to  $F_{min}$  only when the device is presented with  $\Gamma_o$ . If the reflection coefficient of the matching network is other than  $\Gamma_o$ , then the noise figure of the device will be greater than  $F_{min}$  based on the following equation.

$$NF = F_{min} + \frac{4 R_n}{Z_o} \frac{|\Gamma_s - \Gamma_o|^2}{(1 + |\Gamma_o|^2)(1 - |\Gamma_s|^2)}$$

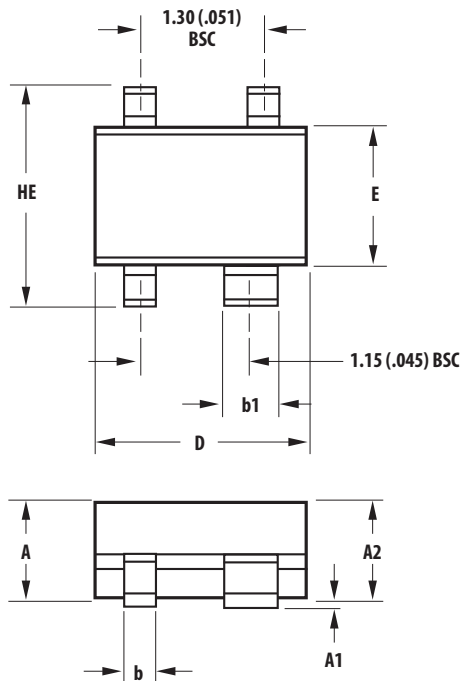
Where  $R_n/Z_o$  is the normalized noise resistance,  $\Gamma_o$  is the optimum reflection coefficient required to produce  $F_{min}$  and  $\Gamma_s$  is the reflection coefficient of the source impedance actually presented to the device. The losses of the matching networks are non-zero and they will also add to the noise figure of the device creating a higher amplifier noise figure. The losses of the matching networks are related to the Q of the components and associated printed circuit board loss.  $\Gamma_o$  is typically fairly low at higher frequencies and increases as frequency is lowered. Larger gate width devices will typically have a lower  $\Gamma_o$  as compared to narrower gate width devices.

Typically for FETs, the higher  $\Gamma_o$  usually infers that an impedance much higher than  $50\Omega$  is required for the device to produce  $F_{min}$ . At VHF frequencies and even lower L Band frequencies, the required impedance can be in the vicinity of several thousand ohms. Matching to such a high impedance requires very hi-Q components in order to minimize circuit losses. As an example at 900 MHz, when airwound coils ( $Q > 100$ ) are used for matching networks, the loss can still be up to 0.25 dB which will add directly to the noise figure of the device. Using multilayer molded inductors with Qs in the 30 to 50 range results in additional loss over the airwound coil. Losses as high as 0.5 dB or greater add to the typical 0.15 dB  $F_{min}$  of the device creating an amplifier noise figure of nearly 0.65 dB. A discussion concerning calculated and measured circuit losses and their effect on amplifier noise figure is covered in Avago Technologies Application 1085.

## Ordering Information

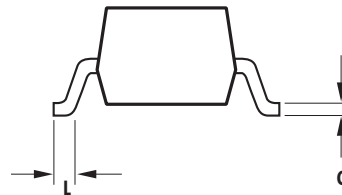
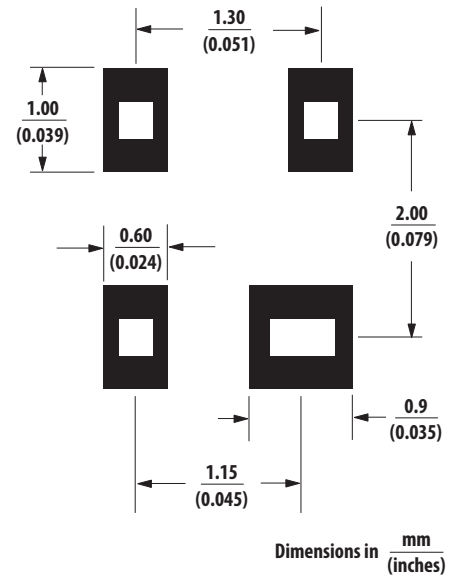
Part Number	No. of Devices	Container
ATF-55143-TR1G	3000	7" Reel
ATF-55143-TR2G	10000	13" Reel
ATF-55143-BLKG	100	antistatic bag

## Package Dimensions Outline 43 (SOT-343/SC70 lead)



SYMBOL	DIMENSIONS (mm)	
	MIN.	MAX.
E	1.15	1.35
D	1.85	2.25
HE	1.80	2.40
A	0.80	1.10
A2	0.80	1.00
A1	0.00	0.10
b	0.15	0.40
b1	0.55	0.70
c	0.10	0.20
L	0.10	0.46

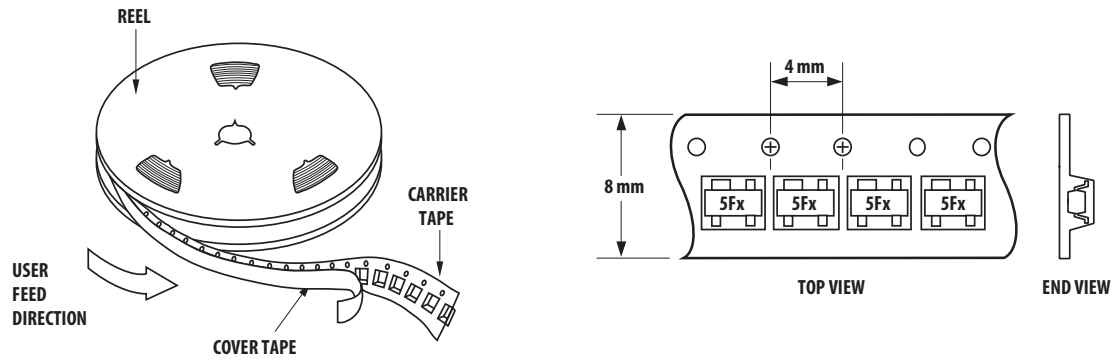
## Recommended PCB Pad Layout for Avago's SC70 4L/SOT-343 Products



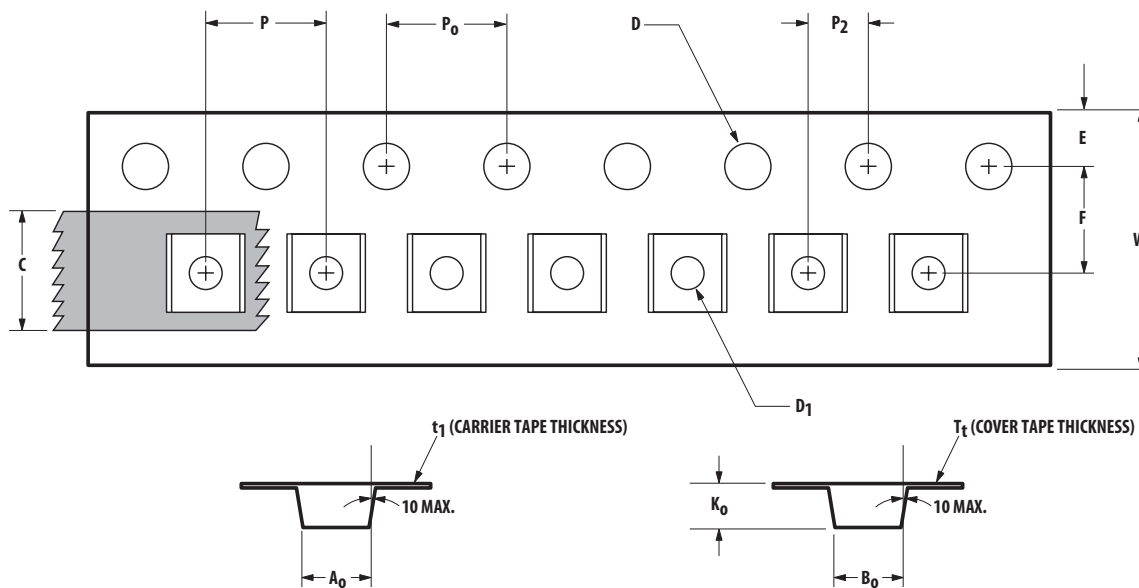
### NOTES:

1. All dimensions are in mm.
2. Dimensions are inclusive of plating.
3. Dimensions are exclusive of mold flash & metal burr.
4. All specifications comply to EIAJ SC70.
5. Die is facing up for mold and facing down for trim/form, ie: reverse trim/form.
6. Package surface to be mirror finish.

## Device Orientation



## Tape Dimensions For Outline 4T



DESCRIPTION		SYMBOL	SIZE (mm)	SIZE (INCHES)
CAVITY	LENGTH	$A_0$	$2.40 \pm 0.10$	$0.094 \pm 0.004$
	WIDTH	$B_0$	$2.40 \pm 0.10$	$0.094 \pm 0.004$
	DEPTH	$K_0$	$1.20 \pm 0.10$	$0.047 \pm 0.004$
	PITCH	P	$4.00 \pm 0.10$	$0.157 \pm 0.004$
	BOTTOM HOLE DIAMETER	$D_1$	$1.00 + 0.25$	$0.039 + 0.010$
	PERFORATION	DIAMETER	D	$1.55 \pm 0.10$
PITCH		$P_0$	$4.00 \pm 0.10$	$0.157 \pm 0.004$
POSITION		E	$1.75 \pm 0.10$	$0.069 \pm 0.004$
CARRIER TAPE	WIDTH	W	$8.00 + 0.30 - 0.10$	$0.315 + 0.012$
	THICKNESS	$t_1$	$0.254 \pm 0.02$	$0.0100 \pm 0.0008$
COVER TAPE	WIDTH	C	$5.40 \pm 0.10$	$0.205 \pm 0.004$
	TAPE THICKNESS	$T_t$	$0.062 \pm 0.001$	$0.0025 \pm 0.0004$
DISTANCE	CAVITY TO PERFORATION (WIDTH DIRECTION)	F	$3.50 \pm 0.05$	$0.138 \pm 0.002$
	CAVITY TO PERFORATION (LENGTH DIRECTION)	$P_2$	$2.00 \pm 0.05$	$0.079 \pm 0.002$

For product information and a complete list of distributors, please go to our web site: [www.avagotech.com](http://www.avagotech.com)

Avago, Avago Technologies, and the A logo are trademarks of Avago Technologies in the United States and other countries. Data subject to change. Copyright © 2005-2012 Avago Technologies. All rights reserved. Obsoletes 5989-3750EN AV02-0923EN - June 8, 2012

**Avago**  
TECHNOLOGIES

## X-ON Electronics

Largest Supplier of Electrical and Electronic Components

*Click to view similar products for [RF JFET Transistors](#) category:*

*Click to view products by [Broadcom](#) manufacturer:*

Other Similar products are found below :

[CE3514M4](#) [CE3514M4-C2](#) [CE3520K3-C1](#) [CE3521M4](#) [CE3521M4-C2](#) [CE3512K2-C1](#) [CE3520K3](#) [CG2H80030D-GP4](#) [TGF2023-2-02](#)  
[NPT1004D](#) [MAGX-011086](#) [NPT25015D](#) [JANTXV2N4858](#) [MMBFJ211](#) [NPT2021](#) [NPTB00025B](#) [2SK3557-6-TB-E](#) [J211\\_D74Z](#)  
[NPTB00004A](#) [QPD0020](#) [QPD1006](#) [QPD1016](#) [QPD1025L](#) [QPD1029L](#) [QPD1881L](#) [T2G6001528-Q3](#) [SKY65050-372LF](#) [TGF2965-SM](#)  
[QPD1009](#) [QPD1010](#) [J304](#) [CGH27015F](#) [CGH55015F1](#) [CMPA801B030F](#) [GTVA262711FA-V2-R0](#) [GTVA262701FA-V2-R0](#) [CGH40006S](#)  
[CGH40010F](#) [CGH40025F](#) [CGH40045F](#) [CGH40120F](#) [CGH55015F2](#) [CGH60008D](#) [CGH60030D](#) [CGHV14500F](#) [CGHV1F006S](#)  
[CGHV1J006D](#) [CGHV27030S](#) [CGHV27060MP](#) [CGHV40030F](#)