

HDSP-2xxx

8-mm (0.31-in.) Ultra Mini Seven Segment Displays

Description

The Broadcom[®] HDSP-2xxx 8-mm (0.31-in.) seven segment displays are space-efficient and feature a right hand decimal point. The use AlInGaP LED chip technology. All devices are available as either common anode or common cathode.

Features

- Compact package
- Evenly lighted segments
- Available in red and green
- Grey/back surface provides optimum contrast
- Right-hand decimal point

CAUTION! This LED is JEDEC HBM Class 1C ESD sensitive. Please observe appropriate precautions during handling and processing. Refer to application note AN-1142 for additional details.

Figure 1: Package Drawing

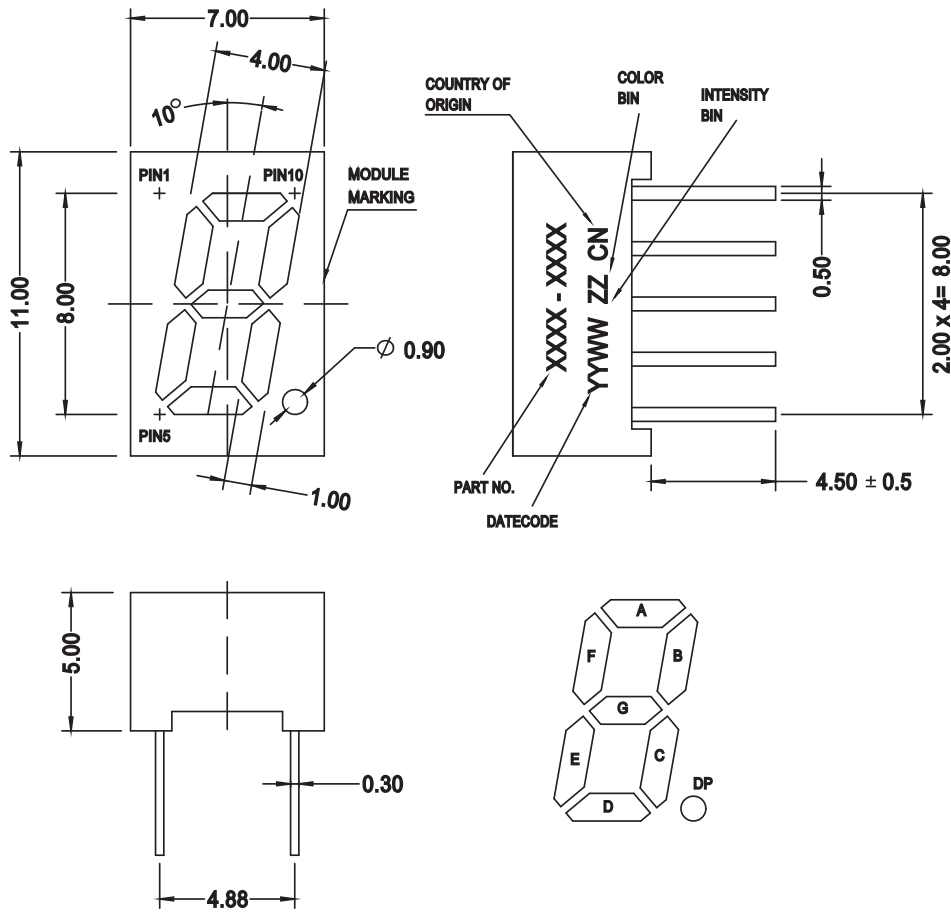

NOTE:

1. All dimensions are in millimeters (mm).
2. Tolerance is ± 0.25 mm unless otherwise specified.
3. Green is categorized for both intensity and color.

Figure 2: Internal Circuit Diagram

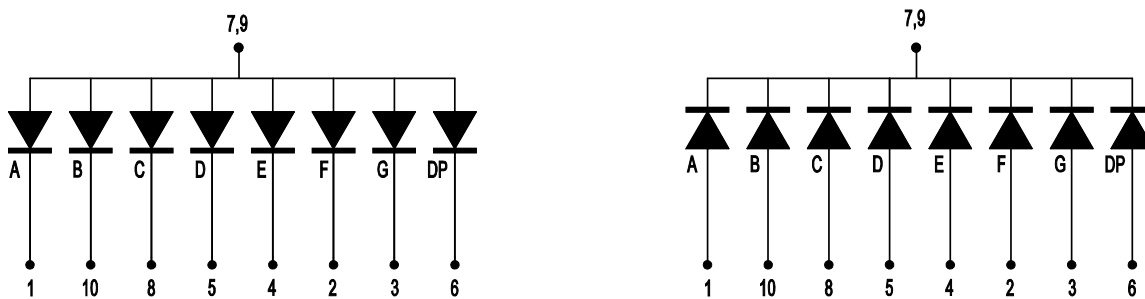

Pin Connection

Pin	Function	
	A	B
1	Cathode A	Anode A
2	Cathode F	Anode F
3	Cathode G	Anode G
4	Cathode E	Anode E
5	Cathode D	Anode D
6	Cathode DP	Anode DP
7	Common Anode	Common Cathode
8	Cathode C	Anode C
9	Common Anode	Common Cathode
10	Cathode B	Anode B

Device Selection Guide

Part Number	Color	Description	Internal Circuit Diagram
HDSP-201G	Green	Common Anode, Grey Surface	A
HDSP-203G	Green	Common Cathode, Grey Surface	B
HDSP-211G	Green	Common Anode, Black Surface	A
HDSP-213G	Green	Common Cathode, Black Surface	B
HDSP-201C	Red	Common Anode, Grey Surface	A
HDSP-203C	Red	Common Cathode, Grey Surface	B
HDSP-211C	Red	Common Anode, Black Surface	A
HDSP-213C	Red	Common Cathode, Black Surface	B

Absolute Maximum Ratings

Parameters	HDSP-2xxx	Unit
DC Forward Current ^a	20	mA
Peak Forward Current ^b	100	mA
Power Dissipation	52	mW
Reverse Voltage	Not designed for reverse bias operation	
Operating Temperature Range	-35 to +85	°C
Storage Temperature Range	-35 to +85	°C
Wave Solder Condition 1.6mm Below Body	260°C peak for 3 seconds	

a. Derate linearly as shown in [Figure 6](#).

b. Duty factor = 10%, frequency = 1 kHz.

Optical and Electrical Characteristics (T_J = 25°C)

Parameters	Min.	Typ.	Max.	Units	Test Condition
Forward Voltage per Segment, V _F ^a				V	I _F = 20 mA
Green	—	2.08	2.60		
Red	—	1.97	2.60		
Reverse Current per Segment, I _R ^b	—	—	100	μA	V _R = 5V
Dominant Wavelength, λ _d ^c				nm	I _F = 20 mA
Green	—	568	—		
Red	—	630	—		
Peak Wavelength, λ _p				nm	I _F = 20 mA
Green	—	571	—		
Red	—	640	—		
Luminous Intensity, I _V ^{d, e, f} (Average per Segment)				mcd	I _F = 10 mA
Green	3.2	6.5	8.0		
Red	8.0	17.0	32.0		
Luminous Intensity Matching Ratio (Segments Only)	—	—	2:1	—	I _F = 10 mA

- a. Forward voltage tolerance is ±0.1V.
- b. Indicates product final test condition. Long term reverse bias is not recommended.
- c. The dominant wavelength, λ_d, is derived from the CIE Chromaticity Diagram and represents the perceived color of the device.
- d. The luminous intensity, I_V, is measured at the mechanical axis of the package and it is tested with a single current pulse condition.
- e. The optical axis is closely aligned with the mechanical axis of the package.
- f. Tolerance is ±15%.

Bin Information

Intensity Bin Limits (CAT)

Bin ID	Luminous Intensity, I _V (mcd)	
	Min.	Max.
Green		
L	3.200	5.050
M	5.051	8.000
Red		
N	8.000	12.500
O	12.501	20.000
P	20.000	32.000

Tolerance = ±15%

Color Bin Limits (BIN)

Bin ID	Dominant Wavelength, λ _d (nm)	
	Min.	Max.
Green		
3	570	574
4	567	571

Tolerance = ±1.0 nm

Example of bin information on reel and packaging label:

CAT : L – Intensity bin L
 BIN : 3 – Color bin 3

Figure 3: Spectral Power Distribution

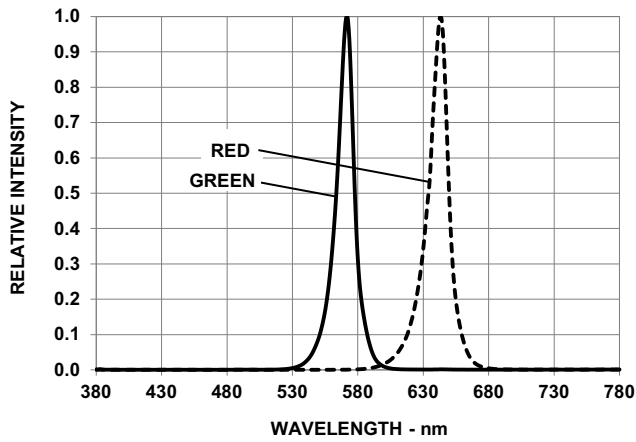

Figure 4: Forward Current vs. Forward Voltage

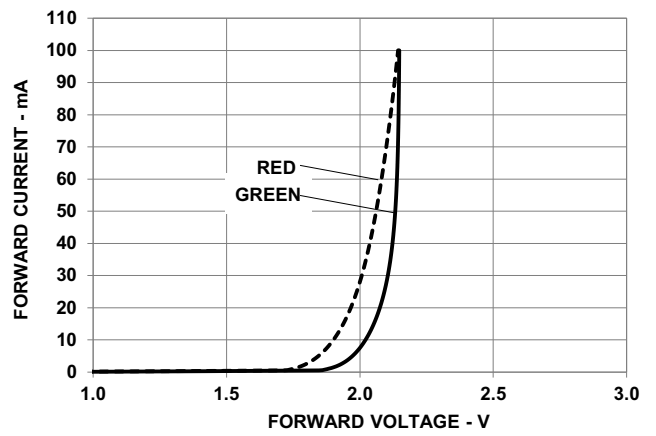

Figure 5: Relative Luminous Intensity vs. Mono Pulse Current

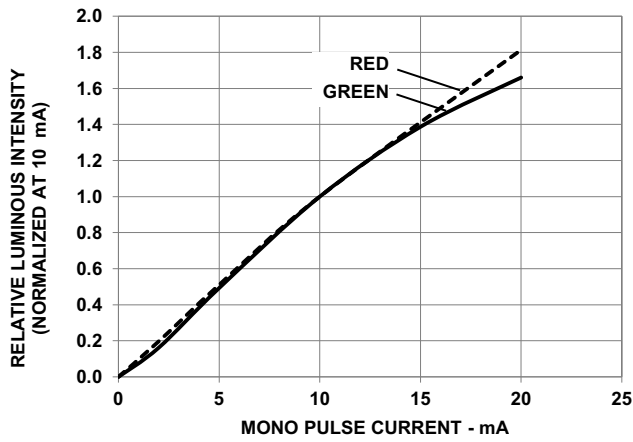
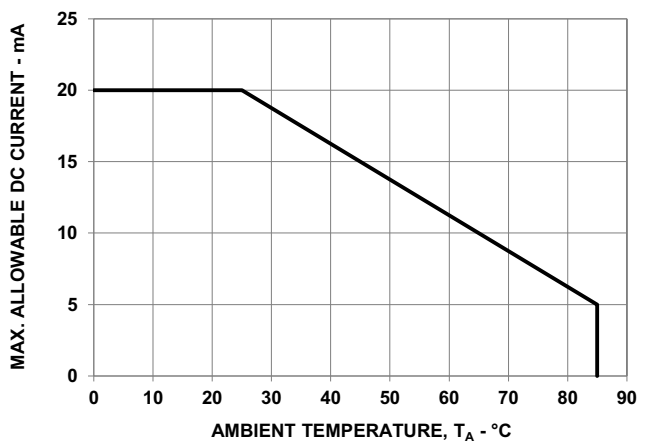

Figure 6: Maximum Forward Current vs. Ambient Temperature



Precautionary Notes

Soldering and Handling Precautions

- Set and maintain the wave soldering parameters according to the recommended temperature and dwell time. Perform daily checks on the profile to ensure that it is always conforming to the recommended conditions. Exceeding these conditions will over-stress the LED display and cause premature failures.
- Use only bottom preheaters to reduce thermal stress experienced by the LED display.
- Recalibrate the soldering profile before loading a new type of PCB. PCBs with different sizes and designs (component density) will have a different heat capacity and might cause a change in temperature experienced by the PCB if the same wave soldering setting is used.
- Do not perform wave soldering more than once.
- Any alignment fixture used during wave soldering must be loosely fitted and must not apply stress on the LED display. Use non-metal material because it will absorb less heat during the wave soldering process.
- At elevated temperatures, the LED display is more susceptible to mechanical stress. Allow the PCB to sufficiently cool to room temperature before handling. Do not apply stress to the LED display when it is hot.
- Use wave soldering to solder the LED display. Use hand soldering only for rework or touch up if unavoidable, but it must be strictly controlled to following conditions:
 - Soldering iron tip temperature = 315°C maximum
 - Soldering duration = 2 seconds maximum
 - Number of cycles = 1 only
 - Power of the soldering iron = 50W maximum
- For ESD-sensitive devices, apply proper ESD precautions at the soldering station. Use only an ESD-safe soldering iron.
- Do not touch the LED display body with the soldering iron except for the soldering terminals because it may cause damage.
- Confirm beforehand whether the functionality and performance of the LED display is affected by soldering with hand soldering.
- Keep the heat source at least 1.6 mm away from the LED display body during soldering.
- Design an appropriate hole size to avoid problems during insertion.

- For purpose of cleaning, wash with DI water only. Cleaning process should take place at room temperature only. Clear any water or moisture from the LED display immediately after washing.
- Cleaning agents from the ketone family (acetone, methyl ethylketone, and so on) and from the chlorinated hydrocarbon family (methylene chloride, trichloroethylene, carbon tetrachloride, and so on) are not recommended for cleaning the LED displays. All of these various solvents attack or dissolve the encapsulating epoxies used to form the package of plastic LED parts.
- Use of "No clean" solder paste is recommended for soldering.

Figure 7: Recommended Wave Soldering Profile

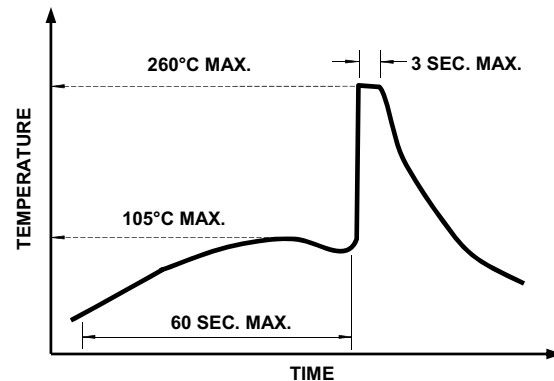

NOTE: Refers to measurements with thermocouple mounted at the bottom of the PCB.

Application Precautions

- The drive current of the LED must not exceed the maximum allowable limit across temperature as stated in the data sheet. Constant current driving is recommended to ensure consistent performance.
- Circuit design must cater to the whole range of forward voltage (V_F) of the LEDs to ensure the intended drive current can always be achieved.
- The LED exhibits slightly different characteristics at different drive currents, which may result in a larger variation of performance (such as intensity, wavelength, and forward voltage). Set the application current as close as possible to the test current to minimize these variations.

- The LED is not intended for reverse bias. Use other appropriate components for such purposes. When driving the LED in matrix form, ensure that the reverse bias voltage does not exceed the allowable limit of the LED.
- Avoid rapid change in ambient temperature, especially in high-humidity environments, because they cause condensation on the LED.

Eye Safety Precautions

LEDs may pose optical hazards when in operation. Do not look directly at operating LEDs because it might be harmful to the eyes. For safety reasons, use appropriate shielding or personal protective equipment.

Disclaimer

Broadcom's products and software are not specifically designed, manufactured, or authorized for sale as parts, components, or assemblies for the planning, construction, maintenance, or direct operation of a nuclear facility or for use in medical devices or applications. The customer is solely responsible, and waives all rights to make claims against Broadcom or its suppliers, for all loss, damage, expense, or liability in connection with such use.

Broadcom, the pulse logo, Connecting everything, Avago Technologies, Avago, and the A logo are among the trademarks of Broadcom and/or its affiliates in the United States, certain other countries, and/or the EU.

Copyright © 2019 Broadcom. All Rights Reserved.

The term "Broadcom" refers to Broadcom Inc. and/or its subsidiaries. For more information, please visit www.broadcom.com.

Broadcom reserves the right to make changes without further notice to any products or data herein to improve reliability, function, or design. Information furnished by Broadcom is believed to be accurate and reliable. However, Broadcom does not assume any liability arising out of the application or use of this information, nor the application or use of any product or circuit described herein, neither does it convey any license under its patent rights nor the rights of others.

X-ON Electronics

Largest Supplier of Electrical and Electronic Components

Click to view similar products for [LED Displays & Accessories](#) category:

Click to view products by [Broadcom](#) manufacturer:

Other Similar products are found below :

[LTC-2721WC](#) [LTC-4624JD](#) [LTC-4627WC](#) [LTC-571P](#) [LTD-5021AWC](#) [LTM-8522G](#) [LTP-4323P](#) [LTP-747G](#) [LTS-3361JG-06](#) [ELS-316SYGWA/S530-E2](#) [1668](#) [HT-F196NB-5323](#) [IPD2131-27](#) [LDQ-N514RI](#) [LDS-A3506RD](#) [LDS-A3926RI](#) [SC03-12HDB](#) [SI-B9T151550WW](#) [SI-B9V171550WW](#) [SLC-3PF-WL](#) [SLDN-32M-G](#) [1624](#) [LTC-2623WC](#) [LTC-4627JD](#) [LTD-322G](#) [LTD-482PC](#) [LTP-1057AHR](#) [LTP-1457AKR](#) [LTP-3784G-01](#) [LTS-313AP](#) [LTS-4812SKR-P](#) [LTS-547AE](#) [LTS-6780P](#) [446010401-3](#) [HV-7W30-6829](#) [DA43-11GWA](#) [LDD-A516RI-17](#) [LDD-E305RI](#) [LDQ-N3402RI](#) [LDQ-N3606RI](#) [LDT-M2804RI](#) [86004CB830](#) [LTP-3862JD](#) [LTP-2088AKD](#) [LTD-6740P](#) [LTS-6880Y](#) [LDS-SMC3002RISUGTR](#) [LTC-2623E](#) [CC25-12YWA](#) [LDM-6432-P3-UR-1](#)