

HDSP-301C

10-mm (0.39-in.) Slim Font Seven-Segment Display

Description

The Broadcom® 10-mm slim font seven-segment display incorporates a new slim font character design. This slim font features narrow width, specially mitered segments to give a fuller appearance to the illuminated character. The face of this display is painted a neutral gray for enhanced on and off contrast. It uses AlInGaP LED chip technology.

This device is available in a common anode configuration with a right-hand decimal point.

Features

- Excellent appearance
- Slim font design
- Mitered corners, evenly illuminated segments
- Gray face for optimum on and off contrast

Figure 1: Package Drawing

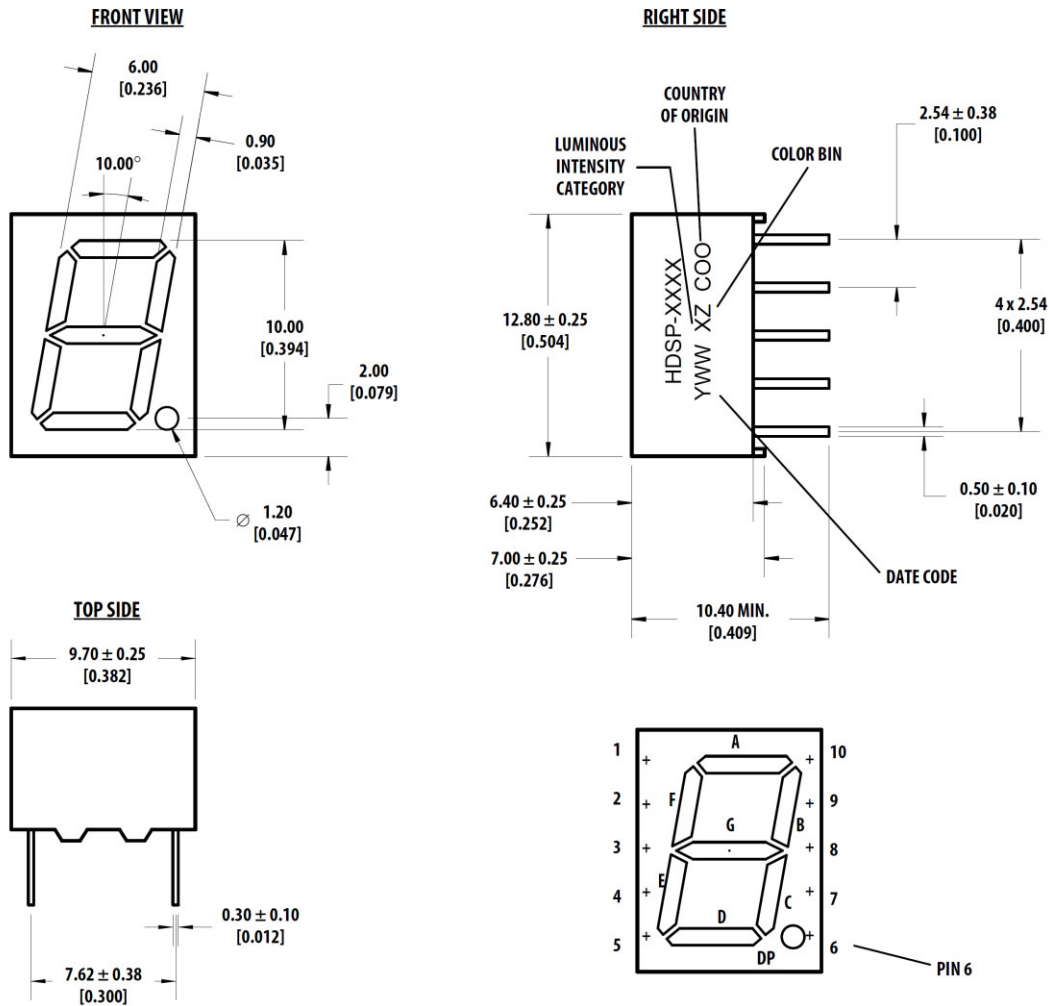

1. All dimensions are in millimeters (mm).
2. Tolerance is ±0.25 mm (0.01 in.) unless otherwise specified.

Figure 2: Internal Circuit Diagram

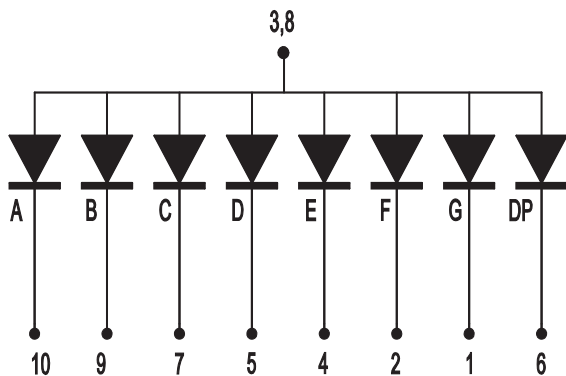

Pin Connection

Pin	Function
1	Cathode G
2	Cathode F
3	Common Anode
4	Cathode E
5	Cathode D
6	Cathode DP
7	Cathode C
8	Common Anode
9	Cathode B
10	Cathode A

Device Selection Guide

Part Number	Color	Description
HDSP-301C	Red	Common Anode, Grey Surface

Absolute Maximum Ratings

Parameters	HDSP-301C	Units
DC Forward Current ^a	20	mA
Peak Forward Current ^b	100	mA
Power Dissipation	52	mW
Reverse Voltage	Not designed for reverse bias operation	
Operating Temperature Range	-40 to +80	°C
Storage Temperature Range	-40 to +80	°C
Wave Solder Condition 1.6mm Below Body	250°C peak for 3secs	

a. Derate linearly as shown in [Figure 6](#).

b. Duty factor = 10%, frequency = 1 kHz.

Optical and Electrical Characteristics ($T_J = 25^\circ\text{C}$)

Parameters	Min.	Typ.	Max.	Units	Test Condition
Forward Voltage per Segment, V_F^a	—	1.97	2.6	V	$I_F = 20\text{ mA}$
Reverse Current per Segment, I_R^b	—	—	100	μA	$V_R = 5\text{V}$
Dominant Wavelength, λ_d^c	—	631	—	—	$I_F = 20\text{ mA}$
Peak Wavelength, λ_p	—	645	—	—	$I_F = 20\text{ mA}$
Luminous Intensity, $I_V^{d, e, f}$ (Average per Segment)	8.6	13.7	—	mcd	$I_F = 10\text{ mA}$
Luminous Intensity Matching Ratio I_{V-m} (Segments only)	—	—	2:1	—	$I_F = 10\text{ mA}$

- Forward voltage tolerance is $\pm 0.1\text{V}$.
- Indicates product final test condition. Long term reverse bias is not recommended.
- The dominant wavelength, λ_d is derived from the CIE Chromaticity Diagram and represents the perceived color of the device.
- The luminous intensity, I_V is measured at the mechanical axis of the package.
- The optical axis is closely aligned with the mechanical axis of the package.
- Tolerance is $\pm 15\%$.

Bin Information

Intensity Bin Limits (CAT)

Bin ID	Luminous Intensity, I_V (mcd)	
	Min.	Max.
Red		
N	8.601	13.700
P	13.701	21.800

Tolerance = $\pm 15\%$.

Example of bin information on reel and packaging label:

CAT: N — Intensity bin N

Figure 3: Spectral Power Distribution

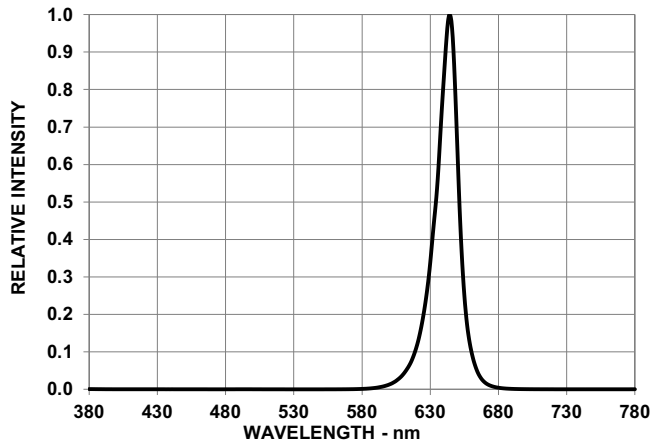

Figure 4: Forward Current vs. Forward Voltage

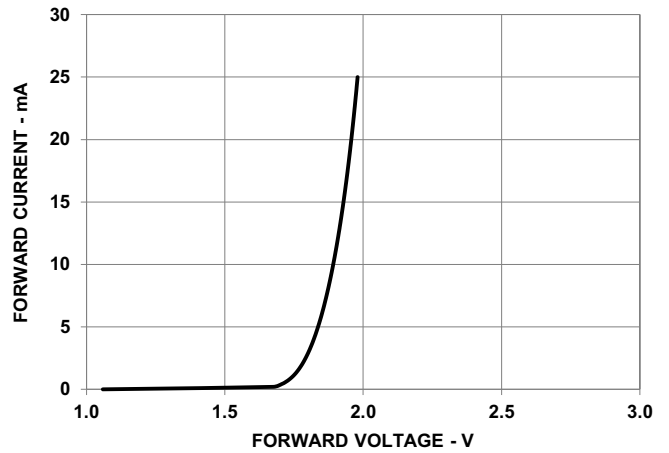

Figure 5: Relative Luminous Intensity vs. Forward Current

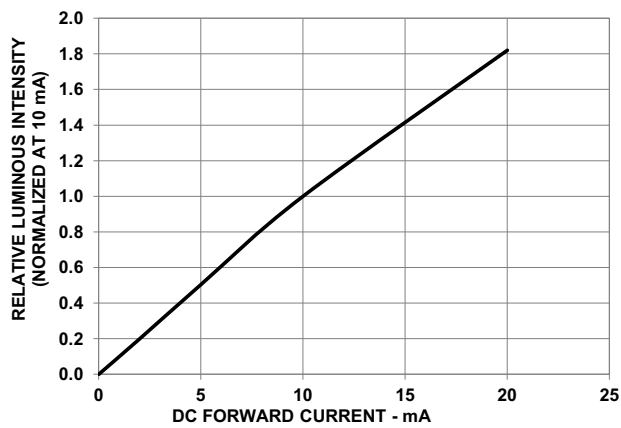
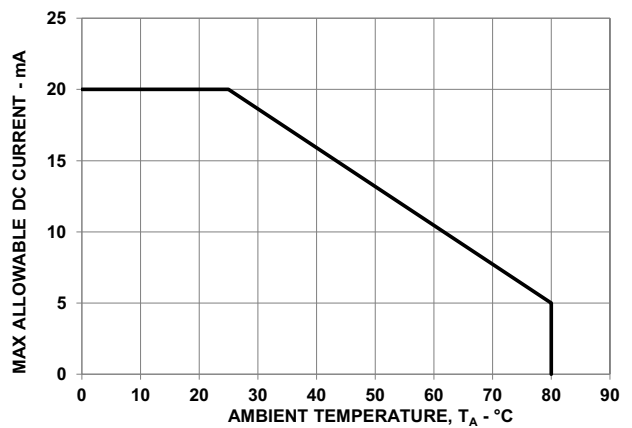

Figure 6: Maximum Forward Current vs. Ambient Temperature



Precautionary Notes

Soldering and Handling Precautions

- Set and maintain the wave soldering parameters according to the recommended temperature and dwell time. Perform daily checks on the profile to ensure that it is always conforming to the recommended conditions. Exceeding these conditions will over-stress the LEDs and cause premature failures.
- Use only bottom preheaters to reduce thermal stress experienced by the LEDs.
- Recalibrate the soldering profile before loading a new type of a PCB. PCBs with different sizes and designs (component density) will have different heat capacities and might cause a change in temperature experienced by the PCB if the same wave soldering setting is used.
- Do not perform wave soldering more than once.
- Any alignment fixture used during wave soldering must be loosely fitted and must not apply stress on the LEDs. Use non-metal material because it will absorb less heat during the wave soldering process.
- At elevated temperatures, the LEDs are more susceptible to mechanical stress. Allow the PCB to be sufficiently cooled to room temperature before handling. Do not apply stress to the LED when it is hot.
- Use wave soldering to solder the LED. Use hand soldering only for rework or touch up if unavoidable, but it must be strictly controlled to following conditions:
 - Soldering iron tip temperature = 315°C maximum.
 - Soldering duration = 2 seconds maximum.
 - Number of cycle = 1 only.
 - Power of soldering iron = 50W maximum.
- For ESD-sensitive devices, apply proper ESD precautions at the soldering station. Use only an ESD-safe soldering iron.
- Do not touch the LED package body with the soldering iron except for the soldering terminals because it may cause damage to the LED.
- Confirm beforehand whether the functionality and performance of the LED is affected by soldering with hand soldering.
- Keep the heat source at least 1.6 mm away from the LED body during soldering.
- Design an appropriate hole size to avoid problems during insertion.
- Cleaning agents from the ketone family (acetone, methyl ethylketone, and so on) and from the chlorinated hydrocarbon family (methylene chloride, trichloroethylene, carbon tetrachloride, and so on) are

not recommended for cleaning the LED displays. All of these various solvents attack or dissolve the encapsulating epoxies used to form the package of plastic LED parts.

Figure 7: Recommended Wave Soldering Profile

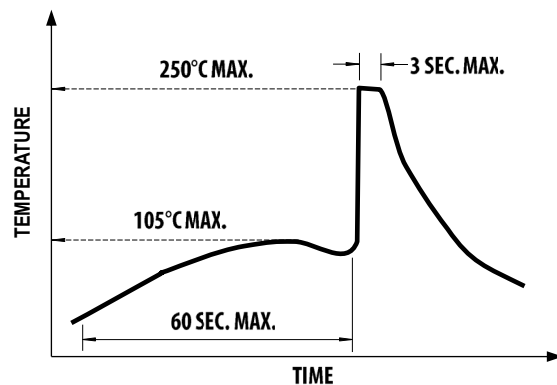

NOTE: Figure 7 refers to measurements with thermocouple mounted at the bottom of the PCB.

Application Precautions

- The drive current of the LED must not exceed the maximum allowable limit across temperatures as stated in the data sheet. Constant current driving is recommended to ensure consistent performance.
- Circuit design must cater to the whole range of forward voltage (V_F) of the LEDs to ensure the intended drive current can always be achieved.
- The LED exhibits slightly different characteristics at different drive currents, which may result in a larger variation of performance (such as intensity, wavelength, and forward voltage). Set the application current as close as possible to the test current to minimize these variations.
- The LED is not intended for reverse bias. Use other appropriate components for such purposes. When driving the LED in matrix form, ensure that the reverse bias voltage does not exceed the allowable limit of the LED.
- Avoid rapid change in ambient temperatures, especially in high-humidity environments, because they cause condensation on the LED.

Eye Safety Precautions

LEDs may pose optical hazards when in operation. Do not look directly at operating LEDs because it might be harmful to the eyes. For safety reasons, use appropriate shielding or personal protective equipment.

Disclaimer

Broadcom's products and software are not specifically designed, manufactured, or authorized for sale as parts, components, or assemblies for the planning, construction, maintenance, or direct operation of a nuclear facility or for use in medical devices or applications. The customer is solely responsible, and waives all rights to make claims against Broadcom or its suppliers, for all loss, damage, expense, or liability in connection with such use.

Broadcom, the pulse logo, Connecting everything, Avago Technologies, Avago, and the A logo are among the trademarks of Broadcom and/or its affiliates in the United States, certain other countries, and/or the EU.

Copyright © 2019–2020 Broadcom. All Rights Reserved.

The term "Broadcom" refers to Broadcom Inc. and/or its subsidiaries. For more information, please visit www.broadcom.com.

Broadcom reserves the right to make changes without further notice to any products or data herein to improve reliability, function, or design. Information furnished by Broadcom is believed to be accurate and reliable. However, Broadcom does not assume any liability arising out of the application or use of this information, nor the application or use of any product or circuit described herein, neither does it convey any license under its patent rights nor the rights of others.

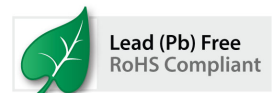

X-ON Electronics

Largest Supplier of Electrical and Electronic Components

Click to view similar products for [LED Displays & Accessories](#) category:

Click to view products by [Broadcom](#) manufacturer:

Other Similar products are found below :

[LTC-2721WC](#) [LTC-4624JD](#) [LTC-4627WC](#) [LTC-571P](#) [LTD-5021AWC](#) [LTM-8522G](#) [LTP-4323P](#) [LTP-747G](#) [LTS-3361JG-06](#) [ELS-316SYGWA/S530-E2](#) [1668](#) [HT-F196NB-5323](#) [IPD2131-27](#) [SA03-12EWA](#) [LDQ-N514RI](#) [LDS-A3506RD](#) [LDS-A3926RI](#) [SC03-12HDB](#) [SI-B9T151550WW](#) [SI-B9V171550WW](#) [SLC-3PF-WL](#) [SLDN-32M-G](#) [1624](#) [LTC-2623WC](#) [LTC-4627JD](#) [LTD-322G](#) [LTD-482PC](#) [LTP-1057AHR](#) [LTP-1457AKR](#) [LTP-3784G-01](#) [LTS-313AP](#) [LTS-4812SKR-P](#) [LTS-547AE](#) [LTS-6780P](#) [446010401-3](#) [DA43-11GWA](#) [LDD-A516RI-17](#) [LDD-E305RI](#) [LDQ-N3402RI](#) [LDQ-N3606RI](#) [LDT-M2804RI](#) [86004CB830](#) [LTP-3862JD](#) [LTP-2088AKD](#) [LTD-6740P](#) [LTS-6880Y](#) [LDS-SMC3002RISUGTR](#) [LTC-2623E](#) [CC25-12YWA](#) [LDM-6432-P3-UR-1](#)