

HDSP-550x, HDSP-552x, HDSP-560x, HDSP-562x, HDSP-570x, HDSP-572x, HDSP-H15x, Series

14.2 mm (0.56 inch)

Seven Segment Displays

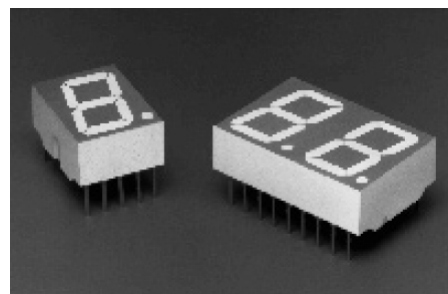

Data Sheet

Description

The 14.2 mm (0.56 inch) LED seven segment displays are designed for viewing distances up to 7 metres (23 feet). These devices use an industry standard size package and pinout. Both the numeric and ± 1 overflow devices feature a right hand decimal point. All devices are available as either common anode or common cathode.

Applications

These displays are ideal for most applications. Pin for pin equivalent displays are also available in a low current design. The low current displays are ideal for portable applications. For additional information see the Low Current Seven Segment Displays data sheet.

Features

- Industry Standard Size
- Industry Standard Pinout
15.24 mm (0.6 in.) DIP Leads on 2.54 mm (0.1 in.) Centers
- Choice of Colors
AlGaAs Red, High Efficiency Red, Yellow, Green
- Excellent Appearance
Evenly Lighted Segments
Mitered Corners on Segments
Gray Package Gives Optimum Contrast
 $\pm 50^\circ$ Viewing Angle
- Design Flexibility
Common Anode or Common Cathode
Single and Dual Digits
Right Hand Decimal Point
 ± 1 . Overflow Character
- Categorized for Luminous Intensity
Yellow and Green Categorized for Color
Use of Like Categories Yields a Uniform Display
- High Light Output
- High Peak Current
- Excellent for Long Digit String Multiplexing
- Intensity and Color Selection Option
See Intensity and Color Selected Displays Data Sheet
- Sunlight Viewable AlGaAs

Devices

| AlGaAs Red HDSP. ^[1] | HER HDSP. ^[1] | Yellow HDSP- | Green HDSP- | Description | Package Drawing |
|------------------------------------|-----------------------------|-----------------|----------------|---|--------------------|
| H151 | 5501 | 5701 | 5601 | Common Anode Right Hand Decimal | A |
| H153 | 5503 | 5703 | 5603 | Common Cathode Right Hand Decimal | B |
| H157 | 5507 | | 5607 | Common Anode ± 1 . Overflow | C |
| H158 | 5508 | | 5608 | Common Cathode ± 1 . Overflow | D |
| | 5521 | 5721 | 5621 | Two Digit Common Anode Right Hand Decimal | E |
| | 5523 | 5723 | 5623 | Two Digit Common Cathode Right Hand Decimal | F |

Note:

1. These displays are recommended for high ambient light operation. Please refer to the HDSP-H10X/K12X AlGaAs and HDSP-555X HER data sheet for low current operation.

Contrast Enhancement

The objective of contrast enhancement is to provide good display readability in the end use ambient light. The concept is to employ both luminance and chrominance contrast techniques to enhance the readability. This is accomplished by having the OFF dots blend into the display background and the ON dots stand out vividly against this same background. Therefore, these display devices are assembled with a gray package and matching encapsulating epoxy in the dots.

Contrast enhancement may be achieved by using one of the following suggested filters:

Standard Red and AlGaAs Red (HDSP-5300/H150)
Panelgraphic RUBY RED 60
SGL-Homalite H100-1605 RED
3M Louvered Filter R6610 RED or N0210 GRAY

HER (HDSP-5500)
Panelgraphic SCARLET RED 60
SGL-Homalite H100-1670 RED or H100-1250 GRAY
3M Louvered Filter R6610 RED or N0210 GRAY

Yellow (HDSP-5700)
Panelgraphic YELLOW 27 or GRAY 10
SGL-Homalite H100-1720 AMBER or H100-1250 GRAY
3M Louvered Filter A5910 AMBER or N0210 GRAY

Green (HDSP-5600)
Panelgraphic GREEN 48
SGL-Homalite H100-1440 GREEN or H100-1250 GRAY
3M Louvered Filter YG6610 RED or N0210 GRAY

For further information on contrast enhancement please see Application Note 1015.

Mechanical

Specially developed plastics are used to optimize the displays optical performance. These plastics restrict the solvents that may be used for cleaning. Only mixtures of Freon (F113) and alcohol should be used for vapor cleaning processes. Total immersion time in the vapors is two minutes. Some suggested mixtures are Freon TE, Arklone A or K, or Genesolv DI-15 or DE-15. A 60°C (140°F) water cleaning process may also be used. This process includes a neutralizer rinse (3% ammonia solution or equivalent), a surfactant rinse (1% detergent solution or equivalent), a water rinse, and a thorough air dry. Room temperature cleaning may be done with Freon T-E35 or T-P35, Ethanol, Isopropanol, or water with a mild detergent.

Cleaning agents from the ketone family (acetone, methyl ethyl ketone, etc.) and from the chlorinated hydrocarbon family (methylene chloride, trichloroethylene, carbon tetrachloride, etc.) are not recommended for cleaning LED parts. All of these various solvents attack or dissolve the encapsulating epoxies used to form the package of plastic LED parts.

Part Numbering System

5082 -X XX X-X X X XX
HDSP-X XX X-X X X XX

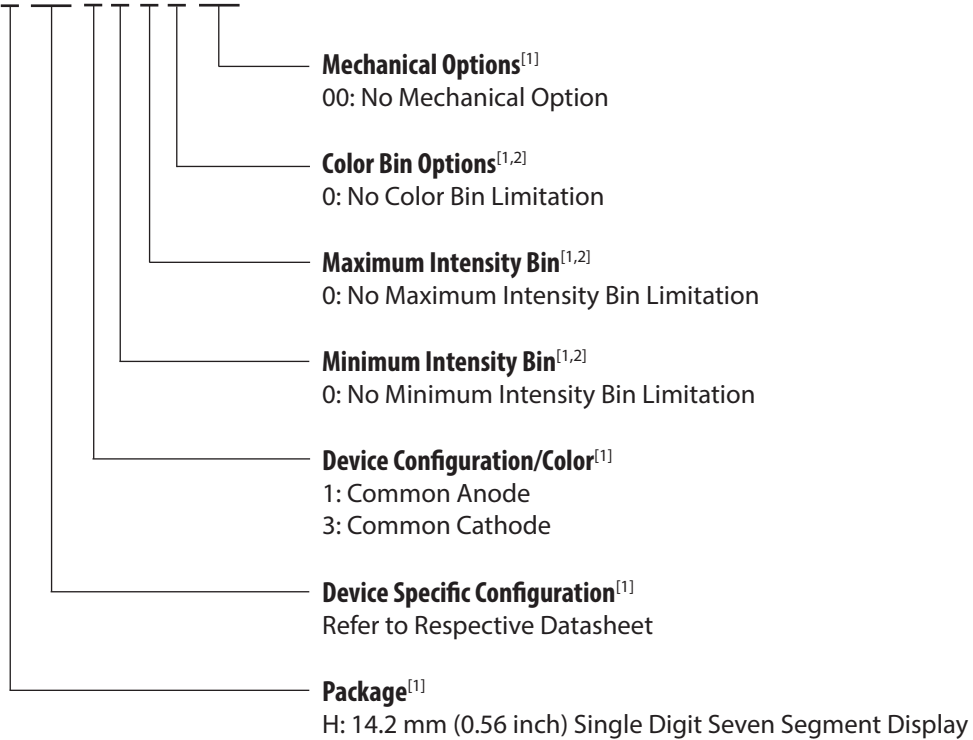

Notes:

1. For codes not listed in the figure above, please refer to the respective datasheet or contact your nearest Avago representative for details.
2. Bin options refer to shippable bins for a part number. Color and Intensity Bins are typically restricted to 1 bin per tube (exceptions may apply). Please refer to respective datasheet for specific bin limit information.

Package Dimensions

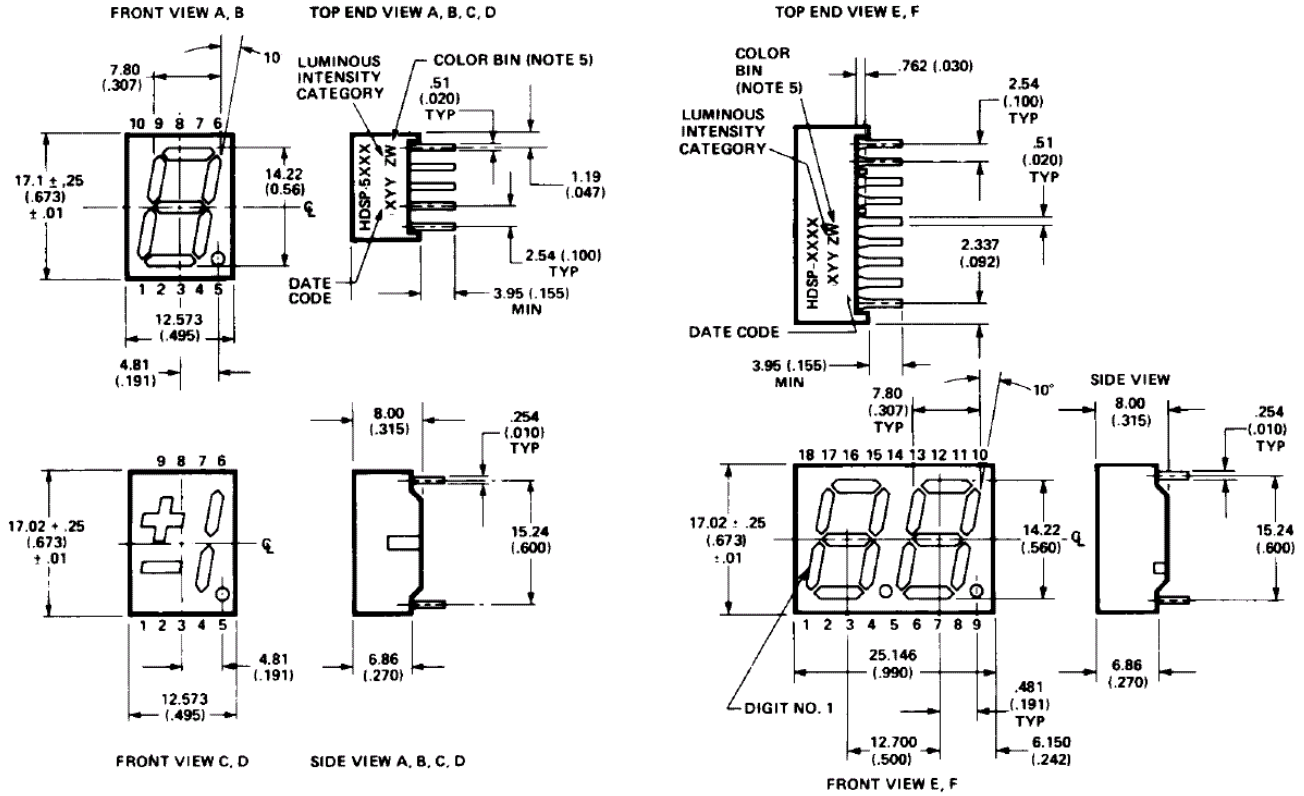

| PIN | FUNCTION | | | | | |
|-----|----------------------|------------------------|----------------|------------------|-------------------|---------------------|
| | A | B | C | D | E | F |
| 1 | CATHODE e | ANODE e | CATHODE c | ANODE c | E CATHODE NO. 1 | E ANODE NO. 1 |
| 2 | CATHODE d | ANODE d | ANODE c, d | CATHODE c, d | D CATHODE NO. 1 | D ANODE NO. 1 |
| 3 | ANODE ^[3] | CATHODE ^[4] | CATHODE b | ANODE b | C CATHODE NO. 1 | C ANODE NO. 1 |
| 4 | CATHODE c | ANODE c | ANODE a, b, DP | CATHODE a, b, DP | DP CATHODE NO. 1 | DP ANODE NO. 1 |
| 5 | CATHODE DP | ANODE DP | CATHODE DP | ANODE DE | E CATHODE NO. 2 | E ANODE NO. 2 |
| 6 | CATHODE b | ANODE b | CATHODE a | ANODE a | D CATHODE NO. 2 | D ANODE NO. 2 |
| 7 | CATHODE a | ANODE a | ANODE a, b, DP | CATHODE a, b, DP | G CATHODE NO. 2 | G ANODE NO. 2 |
| 8 | ANODE ^[3] | CATHODE ^[4] | ANODE c, d | CATHODE c, d | C CATHODE NO. 2 | C ANODE NO. 2 |
| 9 | CATHODE f | ANODE f | CATHODE d | ANODE d | DP CATHODE NO. 2 | DP ANODE NO. 2 |
| 10 | CATHODE g | ANODE g | NO PIN | NO PIN | B CATHODE NO. 2 | B ANODE NO. 2 |
| 11 | | | | | A CATHODE NO. 2 | A ANODE NO. 2 |
| 12 | | | | | F CATHODE NO. 2 | F ANODE NO. 2 |
| 13 | | | | | DIGIT NO. 2 ANODE | DIGIT NO. 2 CATHODE |
| 14 | | | | | DIGIT NO. 1 ANODE | DIGIT NO. 1 CATHODE |
| 15 | | | | | B CATHODE NO. 1 | B ANODE NO. 1 |
| 16 | | | | | A CATHODE NO. 1 | A ANODE NO. 1 |
| 17 | | | | | G CATHODE NO. 1 | G ANODE NO. 1 |
| 18 | | | | | F CATHODE NO. 1 | F ANODE NO. 1 |

NOTES:

1. ALL DIMENSIONS IN MILLIMETRES (INCHES).
2. ALL UNTOLERANCED DIMENSIONS ARE FOR REFERENCE ONLY.
3. REDUNDANT ANODES.
4. REDUNDANT CATHODES.
5. FOR HDSP-5600/-5700 SERIES PRODUCT ONLY.

Internal Circuit Diagram

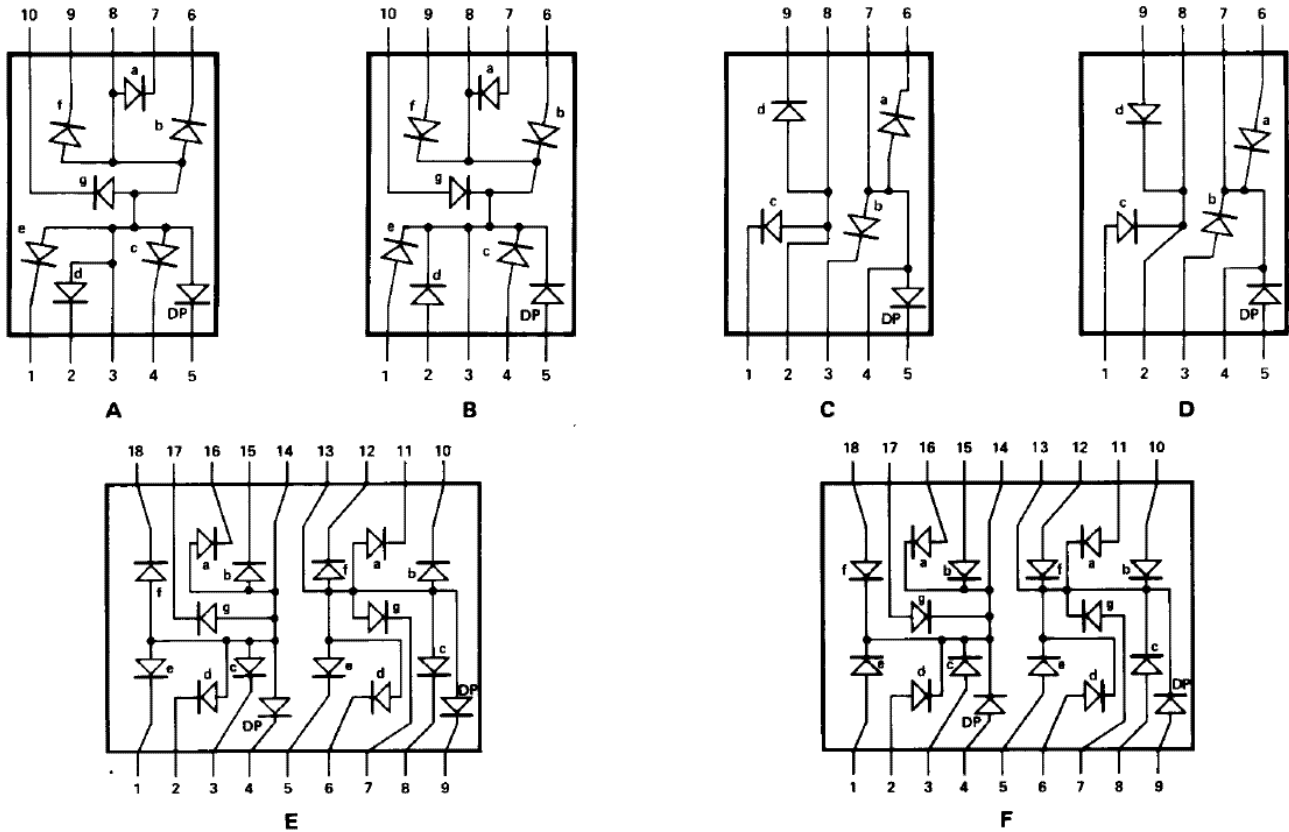

Absolute Maximum Ratings

| Description | AlGaAs Red HDSP-H150 Series | HER HDSP-5500 Series | Yellow HDSP-5700 Series | Green HDSP-5600 Series | Units |
|---|-----------------------------------|----------------------------|-------------------------------|------------------------------|-------|
| Average Power per Segment or DP | 96 | 105 | 80 | 105 | mW |
| Peak Forward Current per Segment or DP | 160 ^[1] | 90 ^[3] | 60 ^[5] | 90 ^[7] | mA |
| DC Forward Current per Segment or DP | 40 ^[2] | 30 ^[4] | 20 ^[6] | 30 ^[8] | |
| Operating Temperature Range | -20 to +100 ^[9] | | -40 to +100 | | °C |
| Storage Temperature Range | | | | -55 to +100 | °C |
| Reverse Voltage* per Segment or DP | | | | 3.0 | V |
| Wavesoldering Temperature for 3 Seconds (1.60 mm [0.063 in.] below body) | | | | 250 | °C |

* Reverse Voltage is for LED testing purpose and not recommended to be used as application condition.

Notes:

- See Figure 2 to establish pulsed conditions.
- Derate above 46°C at 0.54 mA/°C.
- See Figure 7 to establish pulsed conditions.
- Derate above 53°C at 0.45 mA/°C.
- See Figure 8 to establish pulsed conditions.
- Derate above 81°C at 0.52 mA/°C.
- See Figure 9 to establish pulsed conditions.
- Derate above 39°C at 0.37 mA/°C.
- For operation below -20°C, contact your local Avago components sales office or an authorized distributor.

Electrical/Optical Characteristics at $T_A = 25^\circ\text{C}$

AlGaAs Red

| Device Series | Parameter | Symbol | Min. | Typ. | Max. | Units | Test Conditions | |
|--|--|-----------------------------|------|------|------|-------|--------------------------------------|--------------------------|
| H15X | Luminous Intensity/Segment ^(1,2,5) (Digit Average) | I_V | 9.1 | 16.0 | | mcd | $I_F = 20\text{ mA}$ | |
| | Forward Voltage/Segment or DP | V_F | | | | | V | $I_F = 20\text{ mA}$ |
| | | | | | | 1.8 | | $I_F = 100\text{ mA}$ |
| | Peak Wavelength | λ_{PEAK} | | | 645 | | | nm |
| | Dominant Wavelength ⁽³⁾ | λ_d | | | 637 | | | nm |
| | Reverse Voltage/Segment or DP ⁽⁴⁾ | V_R | 3.0 | 15 | | | V | $I_R = 100\ \mu\text{A}$ |
| | Temperature Coefficient of V_F /Segment or DP | $\Delta V_F/^\circ\text{C}$ | | | -2 | | | mV/ $^\circ\text{C}$ |
| Thermal Resistance LED Junction-to-Pin | $R\theta_{\text{J-Pin}}$ | | | 400 | | | $^\circ\text{C}/\text{W}/\text{Seg}$ | |

High Efficiency Red

| Device Series | Parameter | Symbol | Min. | Typ. | Max. | Units | Test Conditions | |
|--|--|-----------------------------|------|------|------|-------|--------------------------------------|--------------------------|
| 55XX | Luminous Intensity/Segment ^(1,2,6) (Digit Average) | I_V | 900 | 2800 | | | μcd | $I_F = 10\text{ mA}$ |
| | | | | | | 3700 | | |
| | Forward Voltage/Segment or DP | V_F | | | 2.1 | 2.5 | V | $I_F = 20\text{ mA}$ |
| | Peak Wavelength | λ_{PEAK} | | | 635 | | | nm |
| | Dominant Wavelength ⁽³⁾ | λ_d | | | 626 | | | nm |
| | Reverse Voltage/Segment or DP ⁽⁴⁾ | V_R | 3.0 | 30 | | | V | $I_R = 100\ \mu\text{A}$ |
| | Temperature Coefficient of V_F /Segment or DP | $\Delta V_F/^\circ\text{C}$ | | | -2 | | | mV/ $^\circ\text{C}$ |
| Thermal Resistance LED Junction-to-Pin | $R\theta_{\text{J-Pin}}$ | | | 345 | | | $^\circ\text{C}/\text{W}/\text{Seg}$ | |

Yellow

| Device Series | Parameter | Symbol | Min. | Typ. | Max. | Units | Test Conditions |
|--|--|-------------------------------|-------|------|------------------------|----------------------|--|
| 57XX | Luminous Intensity/Segment ^(1,2) (Digit Average) | I_V | 600 | 1800 | | μcd | $I_F = 10 \text{ mA}$ |
| | | | | 2750 | | | $I_F = 60 \text{ mA Peak:}$ 1 of 6 df |
| | Forward Voltage/Segment or DP | V_F | | 2.1 | 2.5 | V | $I_F = 20 \text{ mA}$ |
| | Peak Wavelength | λ_{PEAK} | | 583 | | nm | |
| | Dominant Wavelength ^(3,7) | λ_d | 581.5 | 586 | 592.5 | nm | |
| | Reverse Voltage/Segment or DP ⁽⁴⁾ | V_R | 3.0 | 40 | | V | $I_R = 100 \mu\text{A}$ |
| | Temperature Coefficient of V_F /Segment or DP | $\Delta V_F / ^\circ\text{C}$ | | -2 | | mV/ $^\circ\text{C}$ | |
| Thermal Resistance LED Junction-to-Pin | $R\theta_{\text{J-Pin}}$ | | 345 | | $^\circ\text{C/W/Seg}$ | | |

High Performance Green

| Device Series | Parameter | Symbol | Min. | Typ. | Max. | Units | Test Conditions |
|--|--|-------------------------------|------|------|------------------------|----------------------|--|
| 56XX | Luminous Intensity/Segment ^(1,2) (Digit Average) | I_V | 900 | 2500 | | μcd | $I_F = 10 \text{ mA}$ |
| | | | | 3100 | | | $I_F = 60 \text{ mA Peak:}$ 1 of 6 df |
| | Forward Voltage/Segment or DP | V_F | | 2.1 | 2.5 | V | $I_F = 10 \text{ mA}$ |
| | Peak Wavelength | λ_{PEAK} | | 566 | | nm | |
| | Dominant Wavelength ^(3,7) | λ_d | | 571 | 577 | nm | |
| | Reverse Voltage/Segment or DP ⁽⁴⁾ | V_R | 3.0 | 50 | | V | $I_R = 100 \mu\text{A}$ |
| | Temperature Coefficient of V_F /Segment or DP | $\Delta V_F / ^\circ\text{C}$ | | -2 | | mV/ $^\circ\text{C}$ | |
| Thermal Resistance LED Junction-to-Pin | $R\theta_{\text{J-Pin}}$ | | 345 | | $^\circ\text{C/W/Seg}$ | | |

Notes:

1. Device case temperature is 25°C prior to the intensity measurement.
2. The digits are categorized for luminous intensity. The intensity category is designated by a letter on the side of the package.
3. The dominant wavelength, λ_d , is derived from the CIE chromaticity diagram and is that single wavelength which defines the color of the device.
4. Typical specification for reference only. Do not exceed absolute maximum ratings.
5. For low current operation, the AlGaAs HDSP-H10X series displays are recommended. They are tested at 1 mA dc/segment and are pin for pin compatible with the HDSP-H15X series.
6. For low current operation, the HER HDSP-555X series displays are recommended. They are tested at 2 mA dc/segment and are pin for pin compatible with the HDSP-550X series.
7. The Yellow (HDSP-5700) and Green (HDSP-5600) displays are categorized for dominant wavelength. The category is designated by a number adjacent to the luminous intensity category letter.

AlGaAs Red

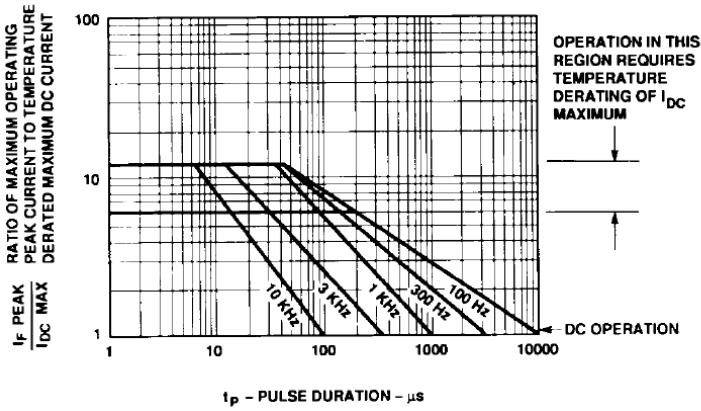

Figure 1. Maximum Tolerable Peak Current vs. Pulse Duration – Red.

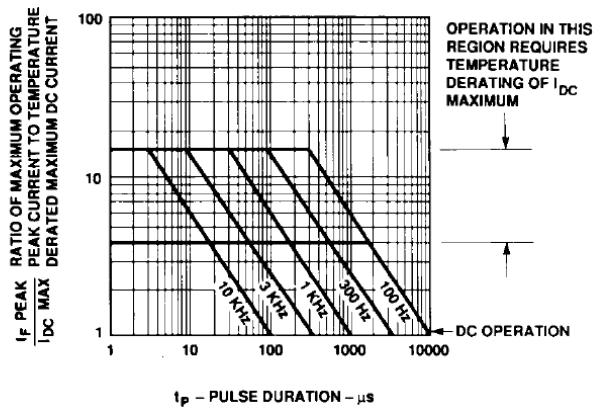

Figure 2. Maximum Tolerable Peak Current vs. Pulse Duration – AlGaAs Red.

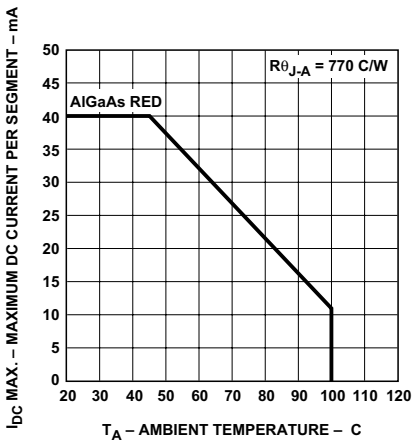

Figure 3. Maximum Allowable DC Current vs. Ambient Temperature.

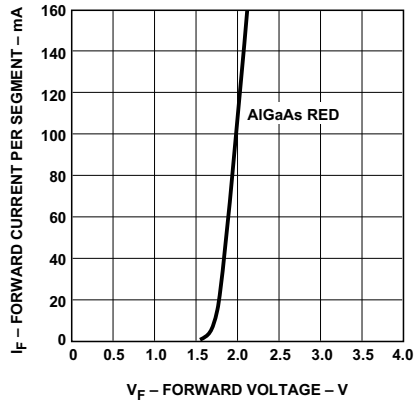

Figure 4. Forward Current vs. Forward Voltage.

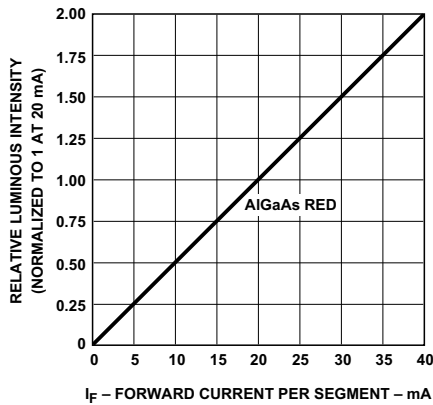

Figure 5. Relative Luminous Intensity vs. DC Forward Current.

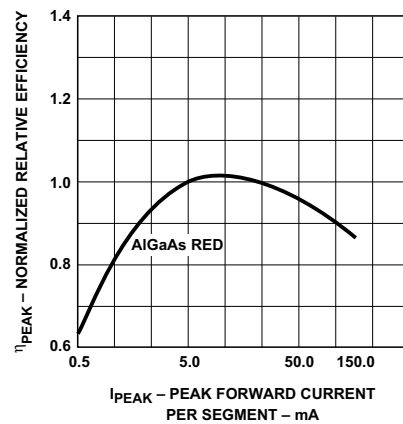

Figure 6. Relative Efficiency (Luminous Intensity per Unit Current) vs. Peak Current.

HER, Yellow, Green

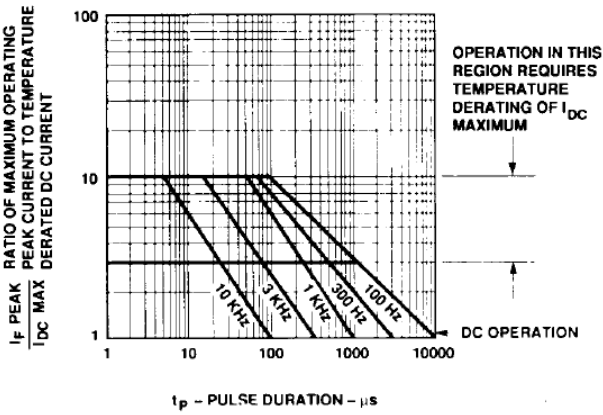

Figure 7. Maximum Tolerable Peak Current vs. Pulse Duration – HER

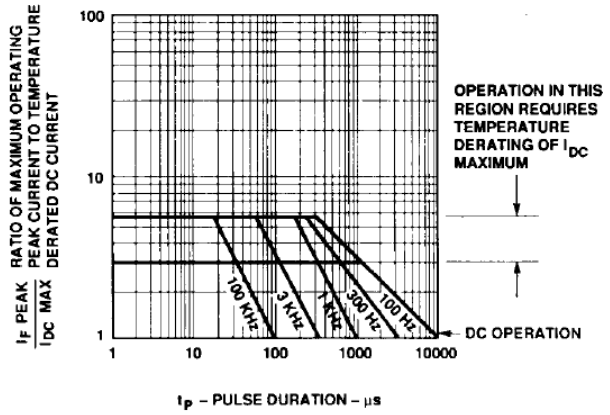

Figure 8. Maximum Tolerable Peak Current vs. Pulse Duration – Yellow.

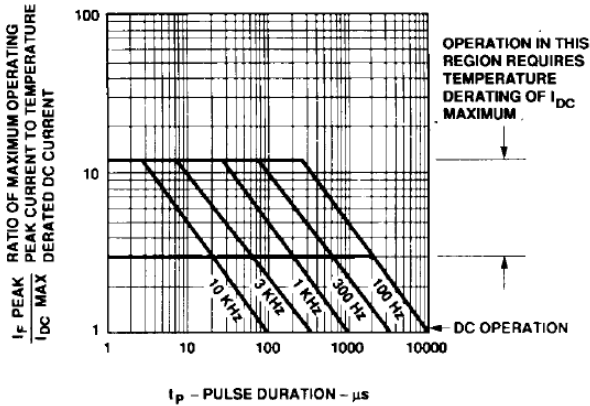

Figure 9. Maximum Tolerable Peak Current vs. Pulse Duration – Green.

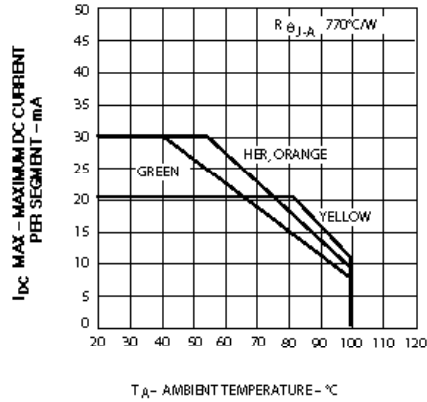

Figure 10. Maximum Allowable DC Current vs. Ambient Temperature.

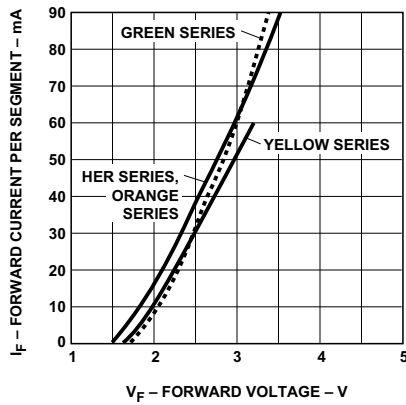

Figure 11. Forward Current vs. Forward Voltage.

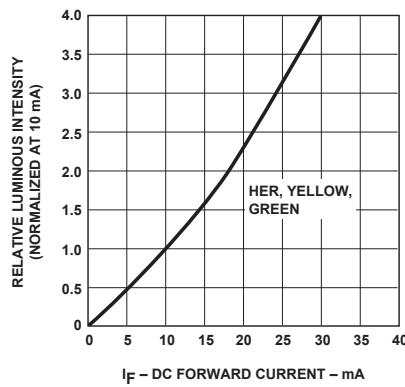

Figure 12. Relative Luminous Intensity vs. DC Forward Current.

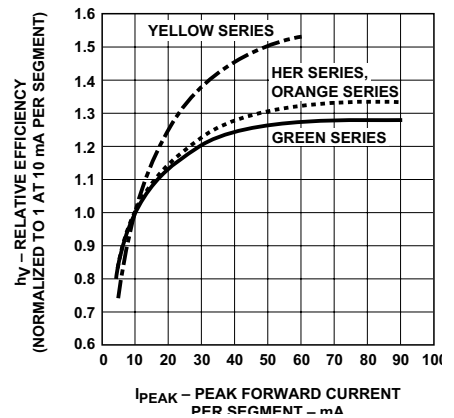

Figure 13. Relative Efficiency (Luminous Intensity per Unit Current) vs. Peak Current.

Electrical/Optical

For more information on electrical/optical characteristics, please see Application Note 1005.

Contrast Enhancement

For information on contrast enhancement please see Application Note 1015.

Soldering/Cleaning

Cleaning agents from the ketone family (acetone, methyl ethyl ketone, etc.) and from the chlorinated hydrocarbon family (methylene chloride, trichloro-ethylene, carbon tetrachloride, etc.) are not recommended for cleaning LED parts. All of these various solvents attack or dissolve the encapsulating epoxies used to form the package of plastic LED parts.

For information on soldering LEDs please refer to Application Note 1027.

Intensity Bin Limits (mcd)

AlGaAs Red

HDSP-H15x

| IV Bin Category | Min. | Max. |
|-----------------|-------|-------|
| K | 9.20 | 16.90 |
| L | 13.80 | 25.30 |
| M | 20.70 | 38.00 |
| N | 31.10 | 56.90 |
| O | 46.60 | 85.40 |

HER

HDSP-550x/552x

| IV Bin Category | Min. | Max. |
|-----------------|-------|-------|
| E | 0.91 | 1.67 |
| F | 1.37 | 2.51 |
| G | 2.05 | 3.76 |
| H | 3.08 | 5.64 |
| I | 4.62 | 8.64 |
| J | 6.93 | 12.70 |
| K | 10.39 | 19.04 |

Yellow

HDSP-570x/572x

| IV Bin Category | Min. | Max. |
|-----------------|-------|-------|
| D | 0.61 | 1.11 |
| E | 0.91 | 1.67 |
| F | 1.37 | 2.51 |
| G | 2.05 | 3.76 |
| H | 3.08 | 5.64 |
| I | 4.62 | 8.64 |
| J | 6.93 | 12.70 |
| K | 10.39 | 19.04 |

Green

HDSP-560x/562x

| IV Bin Category | Min. | Max. |
|-----------------|------|------|
| E | 0.91 | 1.67 |
| F | 1.37 | 2.51 |
| G | 2.05 | 3.76 |
| H | 3.08 | 5.64 |
| I | 4.61 | 8.46 |

Color Categories

| Color | Bin | Dominant Wavelength (nm) | |
|--------|-----|--------------------------|--------|
| | | Min. | Max. |
| Yellow | 1 | 581.50 | 585.00 |
| | 3 | 584.00 | 587.50 |
| | 2 | 586.50 | 590.00 |
| | 4 | 589.00 | 592.50 |
| Green | 2 | 573.00 | 577.00 |
| | 3 | 570.00 | 574.00 |
| | 4 | 567.00 | 571.00 |
| | 5 | 564.00 | 568.00 |

Note:

All categories are established for classification of products. Products may not be available in all categories. Please contact your Avago representatives for further clarification/information.

For product information and a complete list of distributors, please go to our web site: www.avagotech.com

Avago, Avago Technologies, and the A logo are trademarks of Avago Technologies in the United States and other countries. Data subject to change. Copyright © 2005-2015 Avago Technologies. All rights reserved. Obsoletes 5988-4273EN AV02-1107EN - May 26, 2015

AVAGO
TECHNOLOGIES

X-ON Electronics

Largest Supplier of Electrical and Electronic Components

Click to view similar products for [LED Displays & Accessories](#) category:

Click to view products by [Broadcom](#) manufacturer:

Other Similar products are found below :

[LTC-2721WC](#) [LTC-4624JD](#) [LTC-4627WC](#) [LTC-571P](#) [LTD-5021AWC](#) [LTM-8522G](#) [LTP-4323P](#) [LTP-747G](#) [LTS-3361JG-06](#) [ELS-316SYGWA/S530-E2](#) [1668](#) [HT-F196NB-5323](#) [IPD2131-27](#) [SA03-12EWA](#) [LDQ-N514RI](#) [LDS-A3506RD](#) [LDS-A3926RI](#) [SC03-12HDB](#) [SI-B9T151550WW](#) [SI-B9V171550WW](#) [SLC-3PF-WL](#) [SLDN-32M-G](#) [1624](#) [LTC-2623WC](#) [LTC-4627JD](#) [LTD-322G](#) [LTD-482PC](#) [LTP-1057AHR](#) [LTP-1457AKR](#) [LTP-3784G-01](#) [LTS-313AP](#) [LTS-4812SKR-P](#) [LTS-547AE](#) [LTS-6780P](#) [446010401-3](#) [HV-7W30-6829](#) [DA43-11GWA](#) [LDD-A516RI-17](#) [LDD-E305RI](#) [LDQ-N3402RI](#) [LDQ-N3606RI](#) [LDT-M2804RI](#) [86004CB830](#) [LTP-3862JD](#) [LTP-2088AKD](#) [LTD-6740P](#) [LTS-6880Y](#) [LDS-SMC3002RISUGTR](#) [LTC-2623E](#) [CC25-12YWA](#)