

# HDSP-Fxxx Series

## 10 mm (0.40 inch) Seven Segment Displays



### Data Sheet

#### HDSP-F15x/F16x Series

#### HDSP-F20x/F30x/F40x/F50x Series

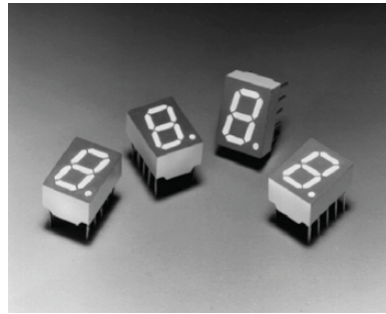

### Description

The 10 mm (0.40 inch) LED seven segment displays are Avago's most space-efficient character size. They are designed for viewing distances up to 4.5 metres (15 feet). These devices use an industry standard size package and pinout. The dual numeric, single numeric, and  $\pm 1$ . overflow devices feature a right hand decimal point. All devices are available as either common anode or common cathode.

Typical applications include instruments, point of sale terminals, and appliances.

### Features

- Industry standard size
- Industry standard pinout
  - 7.6 mm (0.3 inch) DIP single
  - 15.24 mm (0.6 inch) DIP dual
  - Leads on 2.54 mm (0.1 inch) centers
- Choice of colors
  - AlGaAs Red, High Efficiency Red, Orange, Yellow, Green

### Features (Cont.)

- Excellent appearance
  - Evenly lit segments
  - Mitered segment corners
  - Gray package provides optimum contrast
  - Black surface and color tinted epoxy\*
  - \*(HDSP-F161 only)
  - $\pm 50^\circ$  viewing angle
- Design flexibility|
  - Common anode or common cathode
  - Single and dual digits
  - Right hand decimal point
  - $\pm 1$ . overflow character
- Categorized for luminous intensity
  - Yellow and Green categorized for color
  - Use of like categories yields a uniform display
- High light output
- High peak current
- Excellent for long digit string multiplexing
- Intensity and color selection option
- Sunlight viewable AlGaAs

### Devices

AlGaAs Red <sup>(1)</sup> HDSP-	HER HDSP-	Orange HDSP-	Yellow HDSP-	Green HDSP-	Description	Package Drawing
F151	F201	F401	F301	F501	Common Anode Right Hand Decimal	A
F161					Common Anode Right Hand Decimal	A
F153	F203	F403	F303	F503	Common Cathode Right Hand Decimal	B
F157	F207				Common Anode $\pm 1$ . Overflow	C
F158	F208				Common Cathode $\pm 1$ . Overflow	D

Note:

1. These displays are recommended for high ambient light operation. Please refer to the HDSP-F10X data sheet for low current operation.

## Part Numbering System

5082 - X XX X - X X X XX  
 HDSP - X XX X - X X X XX

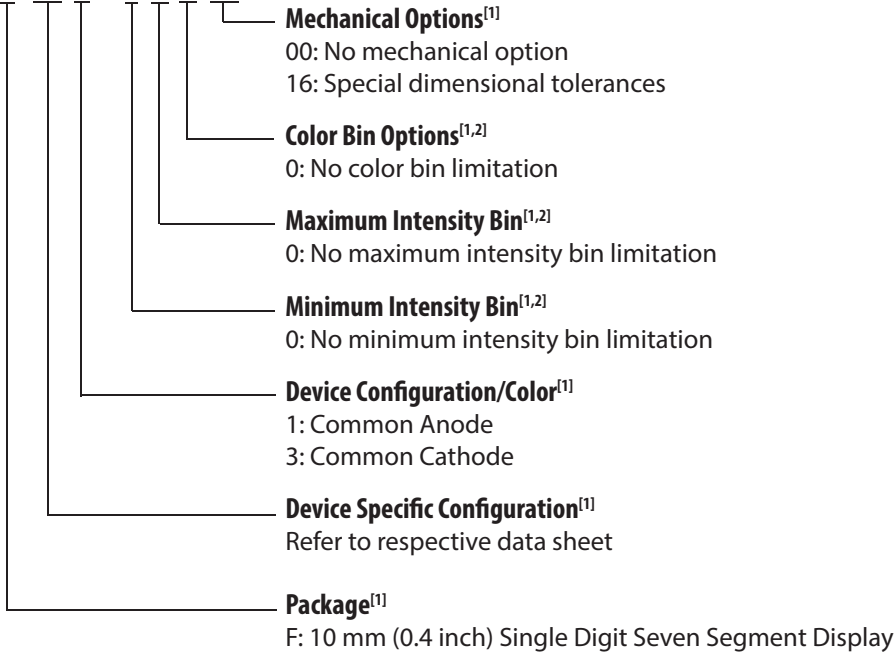

**Notes:**

1. For codes not listed in the figure above, please refer to the respective data sheet or contact your nearest Avago representative for details.
2. Bin options refer to shippable bins for a part-number. Color and Intensity Bins are typically restricted to 1 bin per tube (exceptions may apply). Please refer to respective data sheet for specific bin limit information.

## Package Dimensions

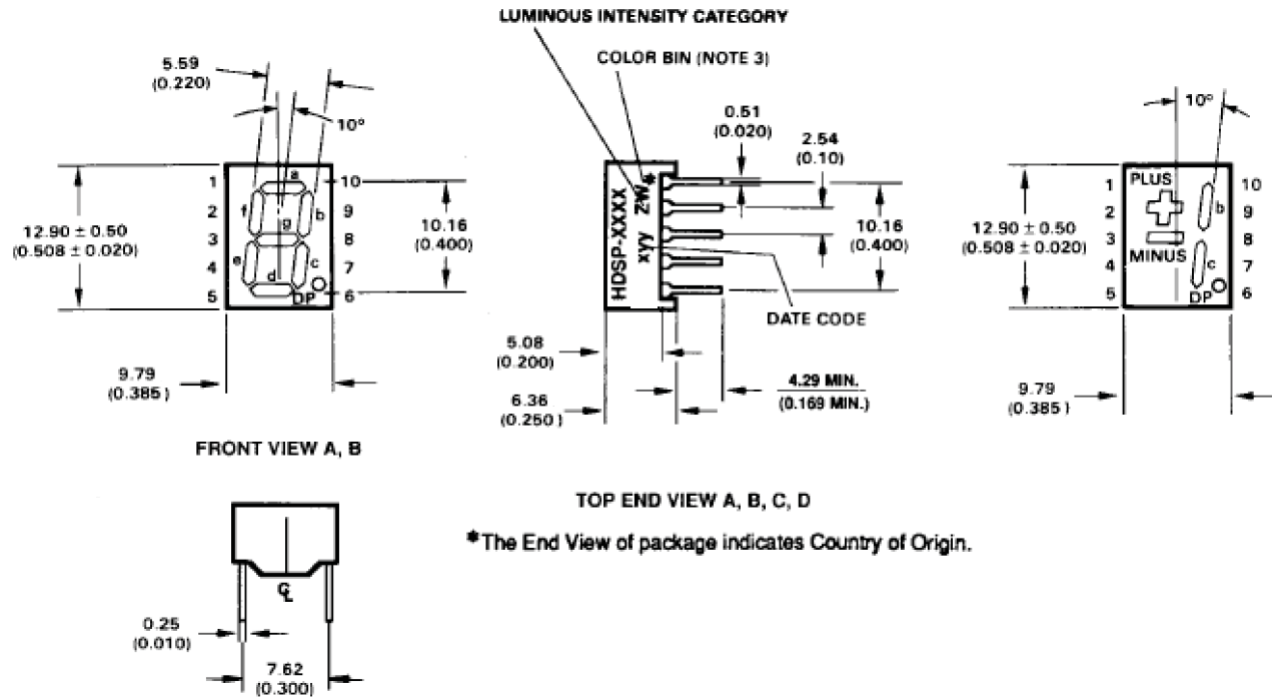

### Internal Circuit Diagram

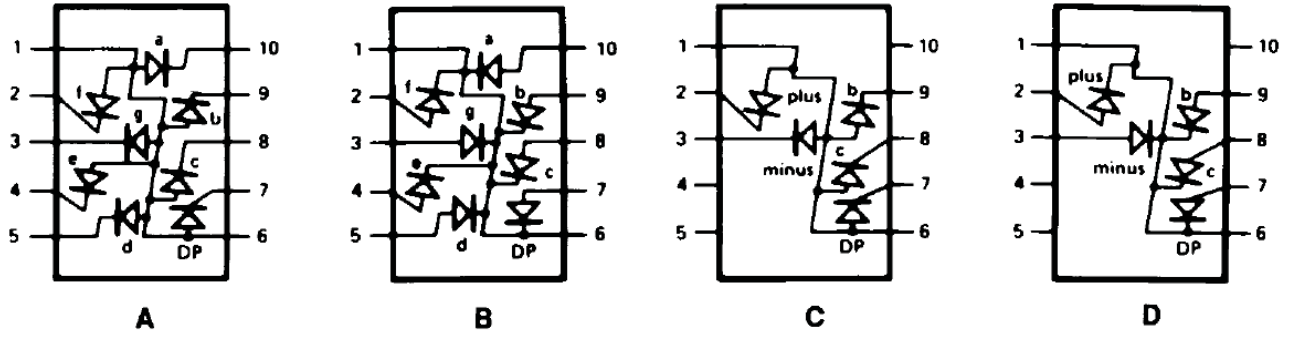

PIN	FUNCTION			
	A	B	C	D
1	ANODE <sup>[1]</sup>	CATHODE <sup>[2]</sup>	ANODE <sup>[1]</sup>	CATHODE <sup>[2]</sup>
2	CATHODE f	ANODE f	CATHODE PLUS	ANODE PLUS
3	CATHODE g	ANODE g	CATHODE MINUS	ANODE MINUS
4	CATHODE e	ANODE e	NC	NC
5	CATHODE d	ANODE d	NC	NC
6	ANODE <sup>[1]</sup>	CATHODE <sup>[2]</sup>	ANODE <sup>[1]</sup>	CATHODE <sup>[2]</sup>
7	CATHODE DP	ANODE DP	CATHODE DP	ANODE DP
8	CATHODE c	ANODE c	CATHODE c	ANODE c
9	CATHODE b	ANODE b	CATHODE b	ANODE b
10	CATHODE a	ANODE a	NC	NC

NOTES:

- 1. REDUNDANT ANODES
- 2. REDUNDANT CATHODES

## Absolute Maximum Ratings

Description	AlGaAs Red	HER/Orange	Yellow	Green	Units
	HDSP-F15x/F16x Series	HDSP-F20x/F40x Series	HDSP-F30x Series	HDSP-F50x Series	
Average Power per Segment or DP	96	105	80	105	mW
Peak Forward Current per Segment or DP	160 <sup>[1]</sup>	90 <sup>[3]</sup>	60 <sup>[5]</sup>	90 <sup>[7]</sup>	mA
DC Forward Current per Segment or DP	40 <sup>[2]</sup>	30 <sup>[4]</sup>	20 <sup>[6]</sup>	30 <sup>[8]</sup>	mA
Operating Temperature Range	-20 to +100 <sup>[9]</sup>		-40 to +100		°C
Storage Temperature Range				-55 to +100	°C
Reverse Voltage per Segment or DP (*reverse voltage is for LED testing purpose and not recommended to be used as application condition)				3.0	V
Wavesoldering Temperature for 3 Seconds (1.59 mm [0.063 in.] below body)				250	°C

### Notes:

- See Figure 1 to establish pulsed conditions.
- Derate above 46°C at 0.54 mA/°C.
- See Figure 6 to establish pulsed conditions.
- Derate above 53°C at 0.45 mA/°C.
- See Figure 7 to establish pulsed conditions.
- Derate above 81°C at 0.52 mA/°C.
- See Figure 8 to establish pulsed conditions.
- Derate above 39°C at 0.37 mA/°C.
- For operation below -20°C, contact your local Avago components sales office or an authorized distributor.

## Electrical/Optical Characteristics at T<sub>A</sub> = 25°C

### AlGaAs Red

Device Series	Parameter	Symbol	Min.	Typ.	Max.	Units	Test Conditions
HDSP-F15x/ F16x	Luminous Intensity/Segment <sup>[1,2,5]</sup> (Digit Average)	I <sub>V</sub>	7.5	15.0		mcd	I <sub>F</sub> = 20 mA
	Forward Voltage/Segment or DP	V <sub>F</sub>		1.8	2.2	V	I <sub>F</sub> = 20 mA
	Peak Wavelength	λ <sub>PEAK</sub>		645		nm	
	Dominant Wavelength <sup>[3]</sup>	λ <sub>d</sub>		637		nm	
	Reverse Voltage/Segment or DP <sup>[4]</sup>	V <sub>R</sub>	3.0	15		V	I <sub>R</sub> = 100 μA
	Temperature Coefficient of V <sub>F</sub> /Segment or DP	ΔV <sub>F</sub> /°C			-2		mV/°C
	Thermal Resistance LED Junction-to-Pin	Rθ <sub>J-PIN</sub>			320		°C/W/Seg

### High Efficiency Red

Device Series	Parameter	Symbol	Min.	Typ.	Max.	Units	Test Conditions
HDSP-F20x	Luminous Intensity/Segment <sup>[1,2]</sup> (Digit Average)	I <sub>V</sub>	420	1200		μcd	I <sub>F</sub> = 5 mA
	Forward Voltage/Segment or DP	V <sub>F</sub>		2.0	2.5	V	I <sub>F</sub> = 20 mA
	Peak Wavelength	λ <sub>PEAK</sub>		635		nm	
	Dominant Wavelength <sup>[3]</sup>	λ <sub>d</sub>		626		nm	
	Reverse Voltage/Segment or DP <sup>[4]</sup>	V <sub>R</sub>	3.0	30		V	I <sub>R</sub> = 100 μA
	Temperature Coefficient of V <sub>F</sub> /Segment or DP	ΔV <sub>F</sub> /°C			-2		mV/°C
	Thermal Resistance LED Junction-to-Pin	Rθ <sub>J-PIN</sub>			320		°C/W/Seg

## Electrical/Optical Characteristics at $T_A = 25^\circ\text{C}$ , continued

### Orange

Device Series	Parameter	Symbol	Min.	Typ.	Max.	Units	Test Conditions
HDSP-F40x	Luminous Intensity/Segment <sup>[1,2]</sup> (Digit Average)	$I_V$	420	1200		$\mu\text{cd}$	$I_F = 5 \text{ mA}$
	Forward Voltage/Segment or DP	$V_F$		2.0	2.5	V	$I_F = 20 \text{ mA}$
	Peak Wavelength	$I_{\text{PEAK}}$		600		nm	
	Dominant Wavelength <sup>[3]</sup>	$I_d$		603		nm	
	Reverse Voltage/Segment or DP <sup>[4]</sup>	$V_R$	3.0	30		V	$I_R = 100 \mu\text{A}$
	Temperature Coefficient of $V_F$ /Segment or DP	$\Delta V_F / ^\circ\text{C}$		-2		mV/ $^\circ\text{C}$	
	Thermal Resistance LED Junction-to-Pin	$R\theta_{\text{J-PIN}}$		320		$^\circ\text{C}/\text{W}/\text{Seg}$	

### Yellow

Device Series	Parameter	Symbol	Min.	Typ.	Max.	Units	Test Conditions
HDSP-F30x	Luminous Intensity/Segment <sup>[1,2]</sup> (Digit Average)	$I_V$	290	800		$\mu\text{cd}$	$I_F = 5 \text{ mA}$
	Forward Voltage/Segment or DP	$V_F$		2.2	2.5	V	$I_F = 20 \text{ mA}$
	Peak Wavelength	$\lambda_{\text{PEAK}}$		583		nm	
	Dominant Wavelength <sup>[3,6]</sup>	$\lambda_d$	581.5	586	592.5	nm	
	Reverse Voltage/Segment or DP <sup>[4]</sup>	$V_R$	3.0	40		V	$I_R = 100 \mu\text{A}$
	Temperature Coefficient of $V_F$ /Segment or DP	$\Delta V_F / ^\circ\text{C}$		-2		mV/ $^\circ\text{C}$	
	Thermal Resistance LED Junction-to-Pin	$R\theta_{\text{J-PIN}}$		320		$^\circ\text{C}/\text{W}/\text{Seg}$	

### High Performance Green

Device Series	Parameter	Symbol	Min.	Typ.	Max.	Units	Test Conditions
HDSP-F50x	Luminous Intensity/Segment <sup>[1,2]</sup> (Digit Average)	$I_V$	1030	3500		$\mu\text{cd}$	$I_F = 10 \text{ mA}$
	Forward Voltage/Segment or DP	$V_F$		2.1	2.5	V	$I_F = 10 \text{ mA}$
	Peak Wavelength	$\lambda_{\text{PEAK}}$		566		nm	
	Dominant Wavelength <sup>[3,6]</sup>	$\lambda_d$		571	577	nm	
	Reverse Voltage/Segment or DP <sup>[4]</sup>	$V_R$	3.0	50		V	$I_R = 100 \mu\text{A}$
	Temperature Coefficient of $V_F$ /Segment or DP	$\Delta V_F / ^\circ\text{C}$		-2		mV/ $^\circ\text{C}$	
	Thermal Resistance LED Junction-to-Pin	$R\theta_{\text{J-PIN}}$		320		$^\circ\text{C}/\text{W}/\text{Seg}$	

#### Notes:

- Case temperature of device immediately prior to the intensity measurement is  $25^\circ\text{C}$ .
- The digits are categorized for luminous intensity. The intensity category is designated by a letter on the side of the package.
- The dominant wavelength,  $\lambda_d$ , is derived from the CIE chromaticity diagram and is that single wavelength which defines the color of the device.
- Typical specification for reference only. Do not exceed absolute maximum ratings.
- For low current operation, the AlGaAs HDSP-F10X series displays are recommended. They are tested at 1 mA dc/segment and are pin for pin compatible with the HDSP-F15X/F16x series.
- The Yellow (HDSP-F30X) series and Green (HDSP-F50X) series displays are categorized for dominant wavelength. The category is designated by a number adjacent to the luminous intensity category letter.

# AlGaAs Red

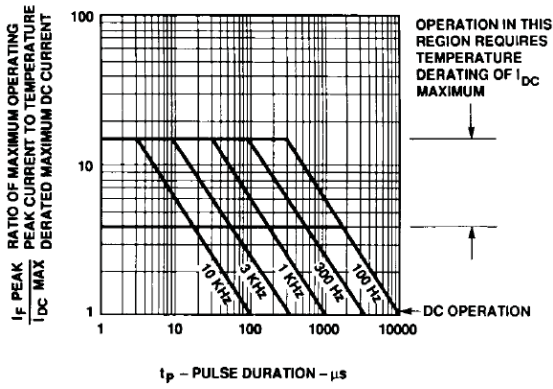

Figure 1. Maximum Tolerable Peak Current vs. Pulse Duration – AlGaAs Red.

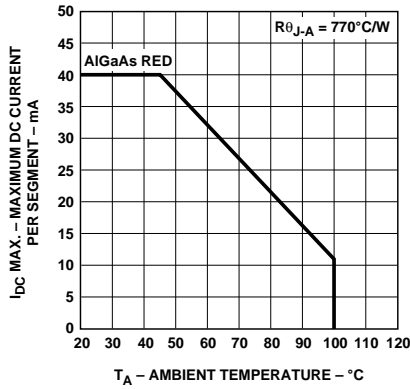

Figure 2. Maximum Allowable DC Current vs. Ambient Temperature.

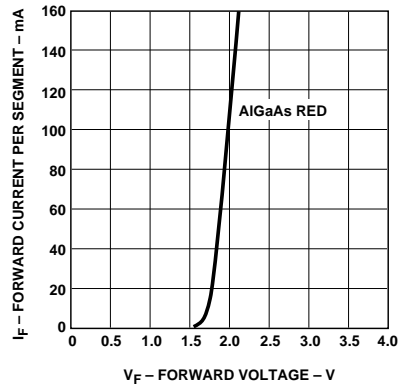

Figure 3. Forward Current vs. Forward Voltage.

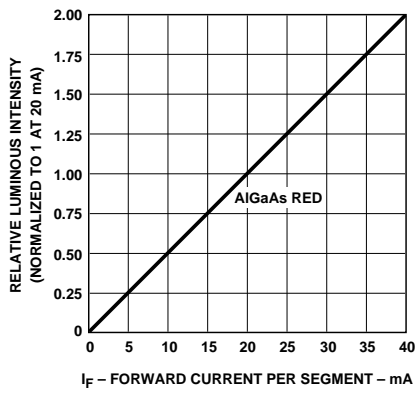

Figure 4. Relative Luminous Intensity vs. DC Forward Current.

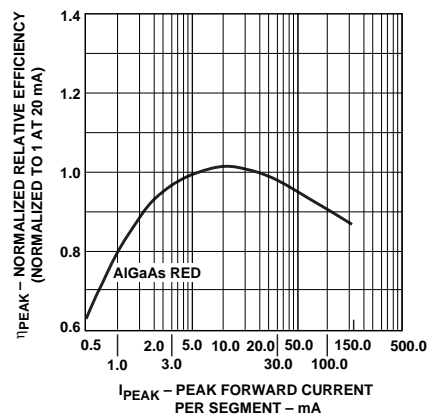

Figure 5. Relative Efficiency (Luminous Intensity per Unit Current) vs. Peak Current.

# HER, Orange, Yellow, Green

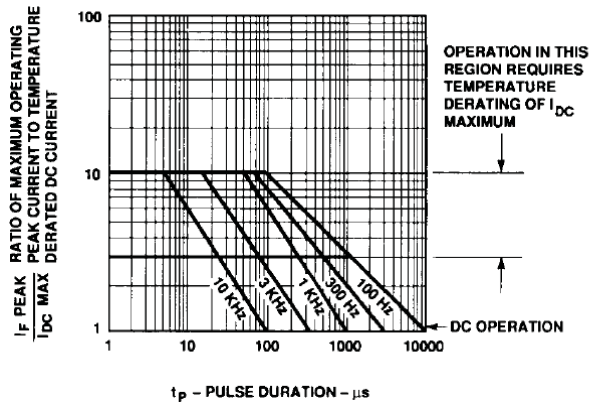

Figure 6. Maximum Tolerable Peak Current vs. Pulse Duration – HER, Orange.

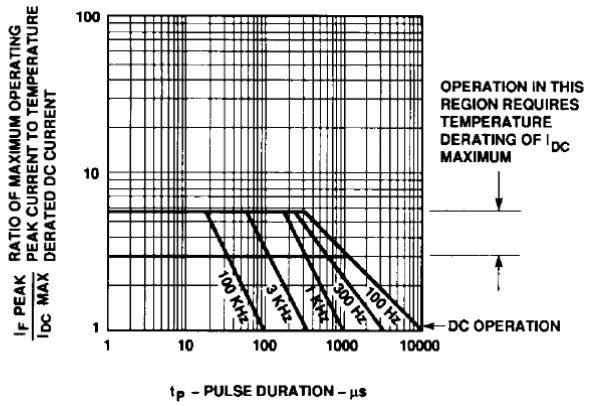

Figure 7. Maximum Tolerable Peak Current vs. Pulse Duration – Yellow.

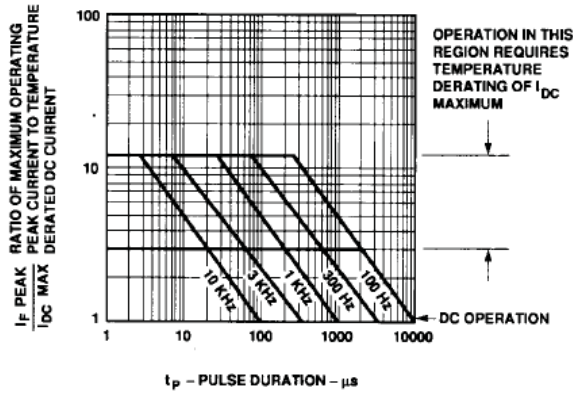

Figure 8. Maximum Tolerable Peak Current vs. Pulse Duration – Green.

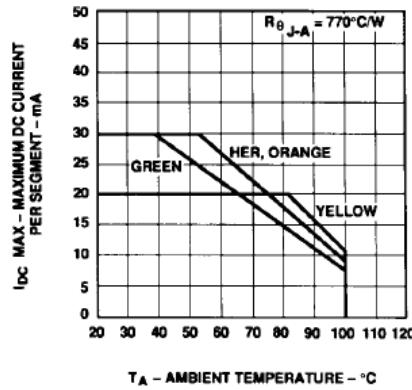

Figure 9. Maximum Allowable DC Current vs. Ambient Temperature.

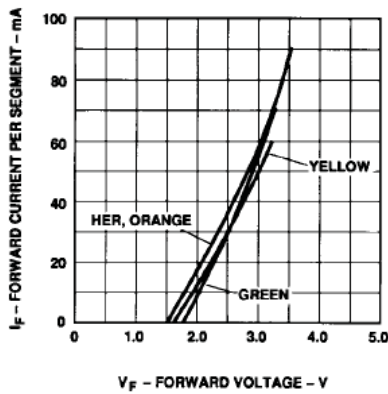

Figure 10. Forward Current vs. Forward Voltage Characteristics.

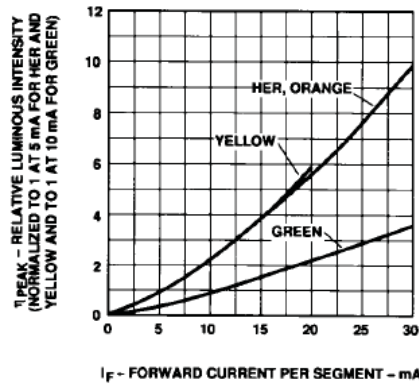

Figure 11. Relative Luminous Intensity vs. DC Forward Current.

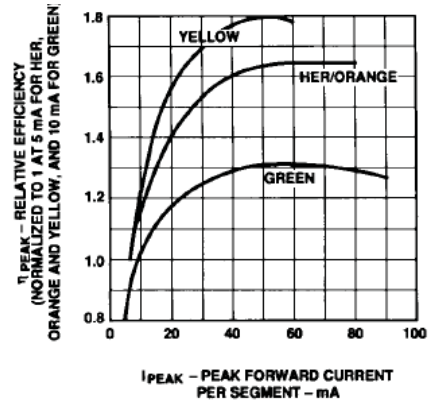

Figure 12. Relative Efficiency (Luminous Intensity per Unit Current) vs. Peak Current.

## Intensity Bin Limits (mcd)

<b>AlGaAs Red</b>		<b>HDSP-F15x/F16x</b>	
<b>IV Bin Category</b>	<b>Min.</b>	<b>Max.</b>	
L	8.67	15.90	
M	13.00	23.80	
N	19.50	35.80	
O	29.30	53.60	
P	43.90	80.50	

<b>HER/Orange</b>		<b>HDSP-F20x/F40x</b>	
<b>IV Bin Category</b>	<b>Min.</b>	<b>Max.</b>	
C	0.485	0.890	
D	0.728	1.333	
E	1.091	2.000	
F	1.636	3.000	
G	2.454	4.500	
H	3.682	6.751	

<b>Yellow</b>		<b>HDSP-F30x</b>	
<b>IV Bin Category</b>	<b>Min.</b>	<b>Max.</b>	
C	0.297	0.543	
D	0.445	0.817	
E	0.669	1.225	
F	1.003	1.838	
G	1.504	2.758	
H	2.256	4.137	

<b>Green</b>		<b>HDSP-F50x</b>	
<b>IV Bin Category</b>	<b>Min.</b>	<b>Max.</b>	
H	1.54	2.82	
I	2.31	4.23	
J	3.46	6.34	
K	5.18	9.50	
L	7.78	14.26	

## Color Categories

<b>Color</b>	<b>Bin</b>	<b>Dominant Wavelength (nm)</b>	
		<b>Min.</b>	<b>Max.</b>
Yellow	1	581.50	585.00
	3	584.00	587.50
	2	586.50	590.00
	4	589.00	592.50
Green	2	573.00	577.00
	3	570.00	574.00
	4	567.00	571.00
	5	564.00	568.00

Note:

All categories are established for classification of products. Products may not be available in all categories. Please contact your local Avago representatives for further clarification/information.

## Contrast Enhancement

For information on contrast enhancement, please see Application Note 1015.

## Soldering/Cleaning

Cleaning agents from the ketone family (acetone, methyl ethyl ketone, etc.) and from the chlorinated hydrocarbon family (methylene chloride, trichloro-ethylene, carbon tetrachloride, etc.) are not recommended for cleaning LED parts. All of these various solvents attack or dissolve the encapsulating epoxies used to form the package of plastic LED parts.

For further information on soldering LEDs, please refer to Application Note 1027.

For product information and a complete list of distributors, please go to our web site: [www.avagotech.com](http://www.avagotech.com)

Avago Technologies and the A logo are trademarks of Avago Technologies in the United States and other countries. Data subject to change. Copyright © 2015-2016 Avago Technologies. All rights reserved. Obsoletes 5989-2346EN AV02-2556EN - January 8, 2016

**AVAGO**  
TECHNOLOGIES



## X-ON Electronics

Largest Supplier of Electrical and Electronic Components

*Click to view similar products for [LED Displays & Accessories](#) category:*

*Click to view products by [Broadcom](#) manufacturer:*

Other Similar products are found below :

[LTC-2721WC](#) [LTC-4624JD](#) [LTC-4627WC](#) [LTC-571P](#) [LTD-5021AWC](#) [LTM-8522G](#) [LTP-4323P](#) [LTP-747G](#) [LTS-3361JG-06](#) [ELS-316SYGWA/S530-E2](#) [1668](#) [HT-F196NB-5323](#) [IPD2131-27](#) [LDQ-N514RI](#) [LDS-A3506RD](#) [LDS-A3926RI](#) [SC03-12HDB](#) [SI-B9T151550WW](#) [SI-B9V171550WW](#) [SLC-3PF-WL](#) [SLDN-32M-G](#) [1624](#) [LTC-2623WC](#) [LTC-4627JD](#) [LTD-322G](#) [LTD-482PC](#) [LTP-1057AHR](#) [LTP-1457AKR](#) [LTP-3784G-01](#) [LTS-313AP](#) [LTS-4812SKR-P](#) [LTS-547AE](#) [LTS-6780P](#) [446010401-3](#) [HV-7W30-6829](#) [DA43-11GWA](#) [LDD-A516RI-17](#) [LDD-E305RI](#) [LDQ-N3402RI](#) [LDQ-N3606RI](#) [LDT-M2804RI](#) [86004CB830](#) [LTP-3862JD](#) [LTP-2088AKD](#) [LTD-6740P](#) [LTS-6880Y](#) [LDS-SMC3002RISUGTR](#) [LTC-2623E](#) [CC25-12YWA](#) [LDM-6432-P3-UR-1](#)