

HDSP-H3x1/H3x3

0.36-in. Single Digit PCB-Based LED Display

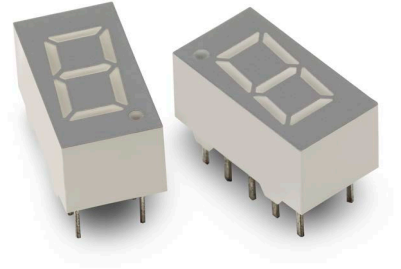

Description

The Broadcom[®] HDSP-H3x1/H3x3 is a 0.36-inch high, single-digit display series. These devices are halogenated and utilize AlInGaP red, orange, and green chips.

All devices are categorized for luminous intensity. The orange and green devices are categorized for color. Use of similar device categories yields a uniform display.

Table 1: Ordering Information

Red	Green	Orange	Description
HDSP-H3E1	HDSP-H3G1	—	Common Anode, Right-Hand Decimal
HDSP-H3E3	—	HDSP-H3L3	Common Cathode, Right-Hand Decimal

Features

- High reliability
- Excellent character appearance
- Available in CA and CC
- RoHS-compliant
- Gray top surface with white diffused segments.

Figure 1: Package Dimension

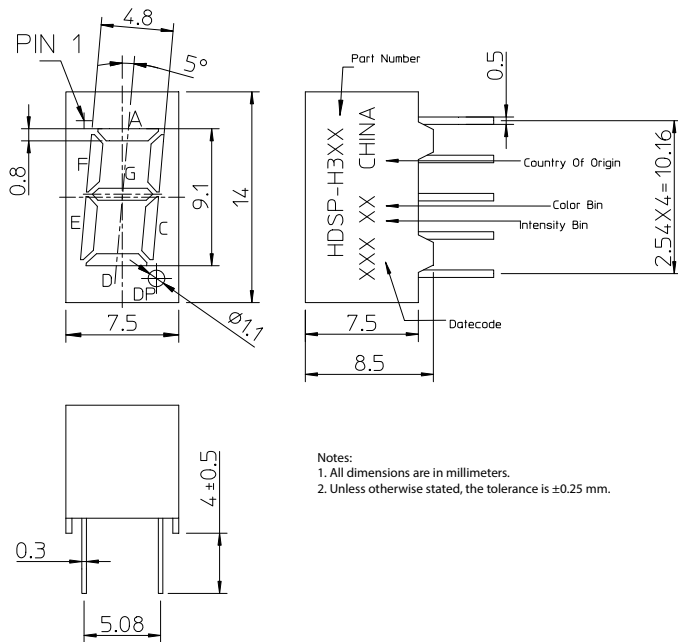
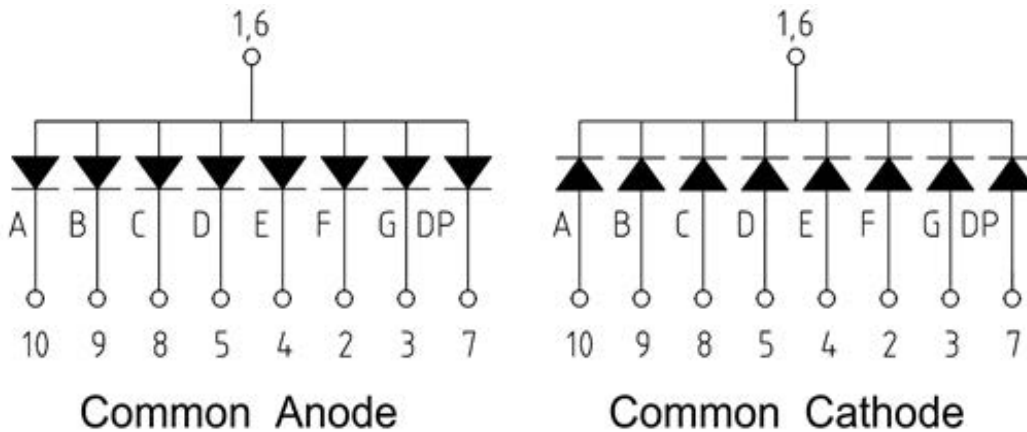

Figure 2: Circuit Diagram



Absolute Maximum Ratings at $T_A = 25^\circ\text{C}$

Parameter	Symbol	Red/Orange/Green	Units
Power Dissipation per Segment or Dot Point (DP)	P_D	52	mW
Continuous Forward Current per Segment	I_F	20	mA
Peak Forward Current per Segment, 1/10 Duty Cycle, 0.1m Second Pulse Width	—	100	mA
Derating Linearly from 25°C per Segment	—	0.21	mA/°C
Reverse Voltage per Segment or DP	V_R	Not designed for reverse biasing	—
Operating Temperature	T_O	-40 to 85	°C
Storage Temperature	T_S	-40 to 85	°C
Wave Solder Condition 1.6 mm Below Body	—	260°C peak for 3 seconds maximum	—

Red Electrical/Optical Characteristics at $T_A = 25^\circ\text{C}$

Parameter	Symbol	Min.	Typ.	Max.	Units	Test Conditions
Average Luminous Intensity, Digit Average	I_V	—	15	—	mcd	$I_F = 10\text{ mA}$
Peak Wavelength	λ_P	—	634	—	nm	$I_F = 20\text{ mA}$
Dominant Wavelength	λ_d	—	625	—	nm	$I_F = 20\text{ mA}$
Forward Voltage per Segment / DP	V_F	—	2.0	2.6	V	$I_F = 20\text{ mA}$
Reverse Current per Segment / DP ^a	I_R	—	—	100	μA	$V_R = 5\text{V}$
Luminous Intensity Matching Ratio, Segment to Segment	I_{V-M}	—	2:1	—	—	$I_F = 10\text{ mA}$

a. Indicates production go-no-go test only. Long term reverse biasing is not recommended.

Green Electrical/Optical Characteristics at $T_A = 25^\circ\text{C}$

Parameter	Symbol	Min.	Typ.	Max.	Units	Test Conditions
Average Luminous Intensity, Digit Average	I_V	—	5	—	mcd	$I_F = 10\text{ mA}$
Peak Wavelength	λ_P	—	572	—	nm	$I_F = 20\text{ mA}$
Dominant Wavelength	λ_d	—	571	—	nm	$I_F = 20\text{ mA}$
Forward Voltage per Segment / DP	V_F	—	2.0	2.6	V	$I_F = 20\text{ mA}$
Reverse Current per Segment / DP ^a	I_R	—	—	100	μA	$V_R = 5\text{V}$
Luminous Intensity Matching Ratio, Segment to Segment	I_{V-M}	—	2:1	—	—	$I_F = 10\text{ mA}$

a. Indicates production go-no-go test only. Long term reverse biasing is not recommended.

Orange Electrical/Optical Characteristics at $T_A = 25^\circ\text{C}$

Parameter	Symbol	Min.	Typ.	Max.	Units	Test Conditions
Average Luminous Intensity, Digit Average	I_V	—	13	—	mcd	$I_F = 10\text{ mA}$
Peak Wavelength	λ_P	—	610	—	nm	$I_F = 20\text{ mA}$
Dominant Wavelength	λ_d	—	605	—	nm	$I_F = 20\text{ mA}$
Forward Voltage per Segment / DP	V_F	—	2.0	2.6	V	$I_F = 20\text{ mA}$
Reverse Current per Segment / DP ^a	I_R	—	—	100	μA	$V_R = 5\text{V}$
Luminous Intensity Matching Ratio, Segment to Segment	I_{V-M}	—	2:1	—	—	$I_F = 10\text{ mA}$

a. Indicates production go-no-go test only. Long term reverse biasing is not recommended.

Red

Figure 3: Relative Luminous Intensity vs. Forward Current

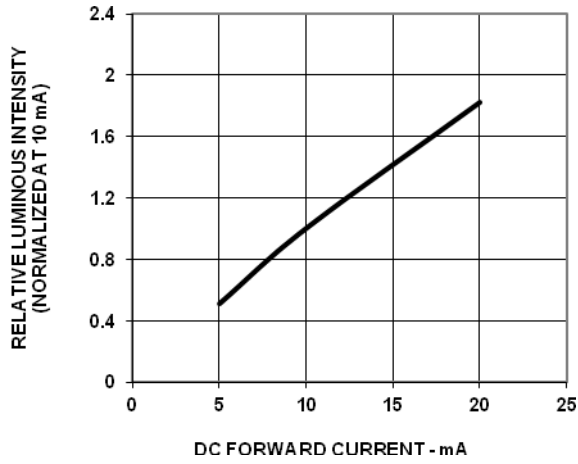

Figure 4: Forward Voltage vs. Current

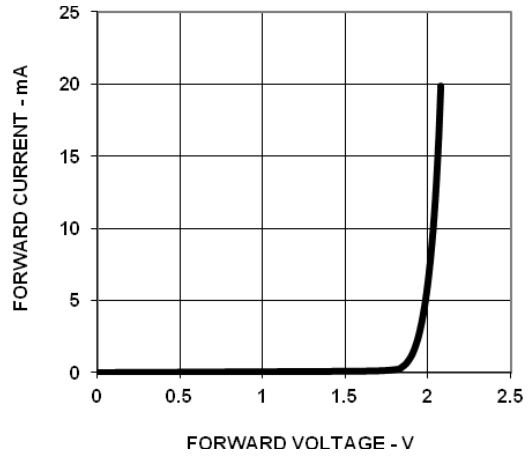
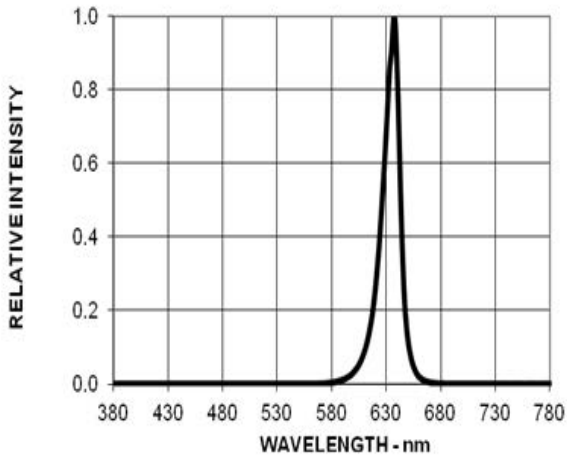

Figure 5: Relative Luminous intensity vs. Wavelength



Green

Figure 6: Relative Luminous Intensity vs. Forward Current

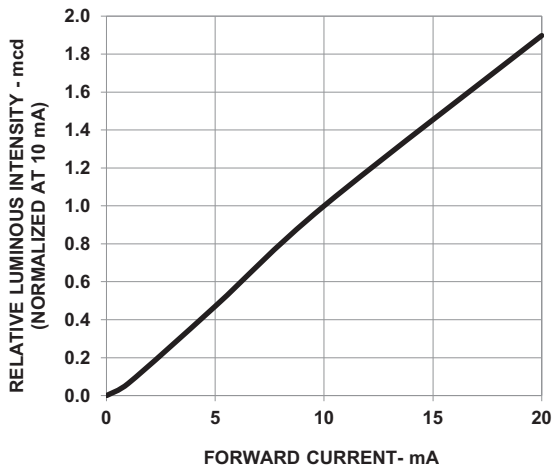

Figure 7: Forward Voltage vs. Current

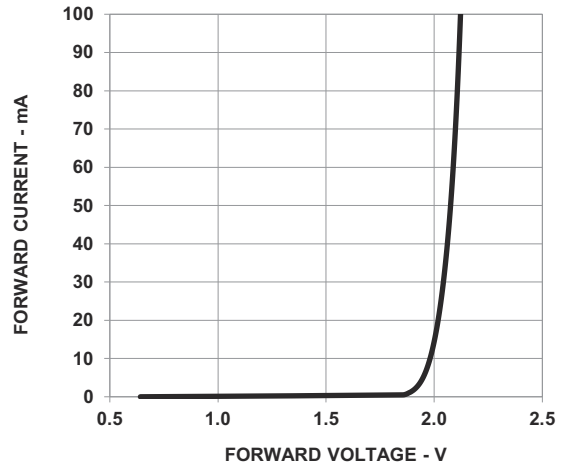
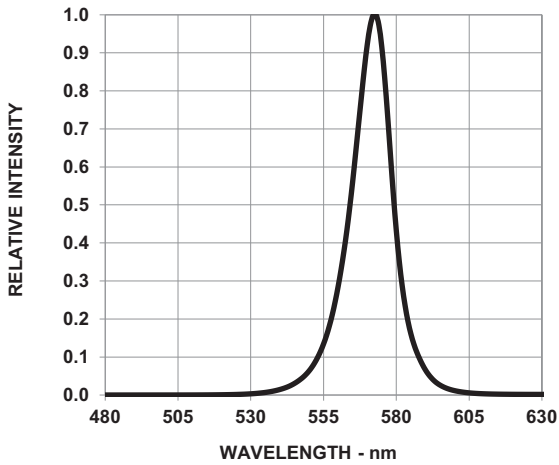

Figure 8: Relative Luminous intensity vs. Wavelength



Orange

Figure 9: Relative Luminous Intensity vs. Forward Current

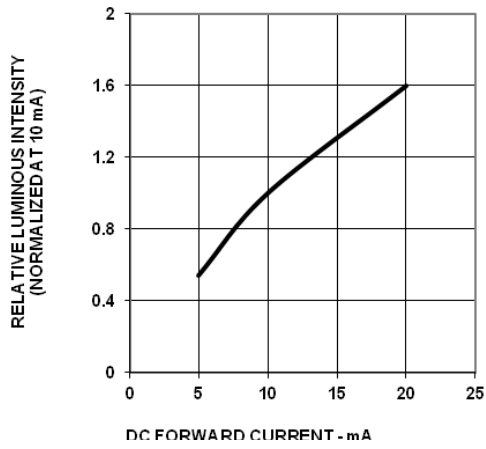

Figure 10: Forward Voltage vs. Current

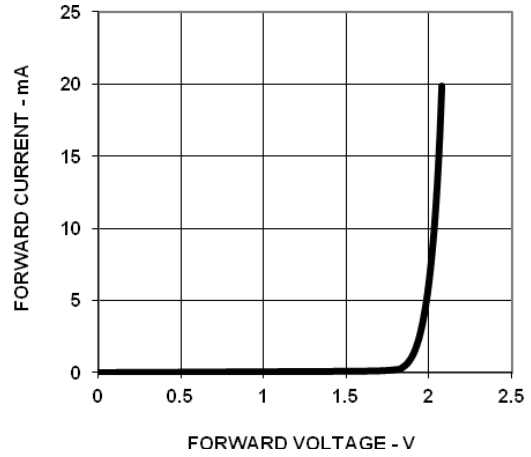
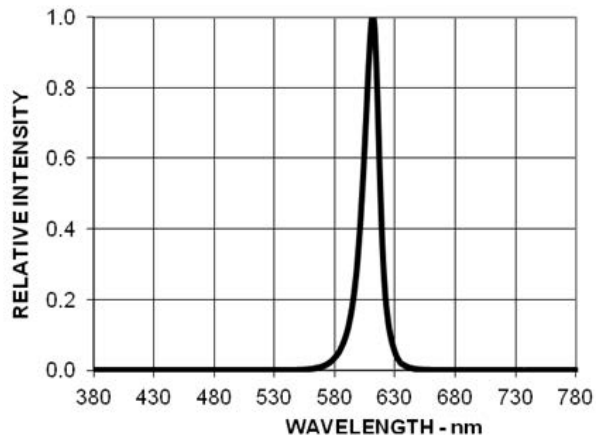
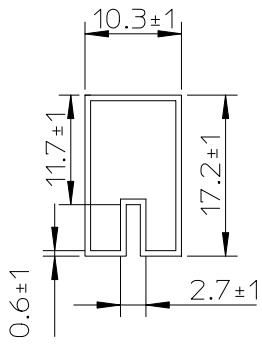
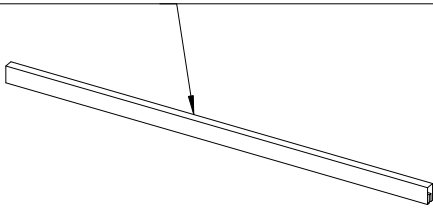

Figure 11: Relative Luminous intensity vs. Wavelength



Packing Tube Specifications

25 PCS PRODUCTS PER IC TUBE



Tube Front View



Tube Top View

Precautionary Notes

Soldering and Handling Precautions

- Set and maintain the wave soldering parameters according to the recommended temperature and dwell time. Perform a daily check on the profile to ensure that it is always conforming to the recommended conditions. Exceeding these conditions will over-stress the LEDs and cause premature failures.
- Use only bottom preheaters to reduce thermal stress experienced by the LEDs.
- Recalibrate the soldering profile before loading a new type of PCB. PCBs with different sizes and designs (component densities) will have different heat capacities and might cause a change in temperature experienced by the PCBs if the same wave soldering settings are used.
- Do not perform wave soldering more than once.
- Any alignment fixture used during wave soldering must be loosely fitted and must not apply stress on the LEDs. Use a non-metal material as it will absorb less heat during the wave soldering process.
- At elevated temperatures, the LEDs are more susceptible to mechanical stress. Allow the PCB to be sufficiently cooled to room temperature before handling. Do not apply stress to the LED when it is hot.
- Use wave soldering to solder the LED. Use hand soldering only for rework or touch up if unavoidable, and it must be strictly controlled to following conditions:
 - Soldering iron tip temperature = 315°C maximum
 - Soldering duration = 2 seconds maximum
 - Number of cycle = 1 only
 - Power of soldering iron = 50W maximum
- For ESD-sensitive devices, apply proper ESD precautions at the soldering station. Use only ESD-safe soldering irons.
- Do not touch the LED package body with the soldering iron except for the soldering terminals as it may cause damage to the LED.
- Confirm beforehand whether the functionality and performance of the LED is affected by soldering with hand soldering.
- Keep the heat source at least 1.6 mm away from the LED body during soldering.
- Design an appropriate hole size to avoid problems during insertion.
- Cleaning agents from the ketone family (acetone, methyl ethylketone, etc.) and from the chlorinated hydrocarbon family (methylene chloride,

trichloroethylene, carbon tetrachloride, etc.) are not recommended for cleaning the LED displays. All of these various solvents attack or dissolve the encapsulating epoxies used to form the package of plastic LED parts.

- For the purpose of cleaning, wash with DI water only. The cleaning process should take place at room temperature only. Clear any water or moisture from the LED display immediately after washing.
- Use of *No clean* solder paste is recommended for soldering.

Figure 12: Recommended Wave Soldering Profile

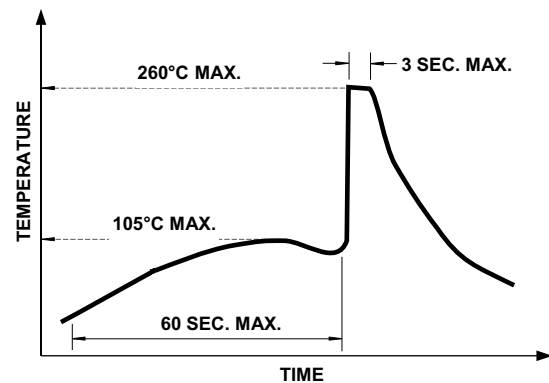

NOTE: Refers to measurements with thermocouple mounted at the bottom of the PCB.

Application Precautions

- The drive current of the LED must not exceed the maximum allowable limit across temperature as stated in the data sheet. Constant current driving is recommended to ensure consistent performance.
- Circuit design must cater to the whole range of forward voltage (V_F) of the LEDs to ensure the intended drive current can always be achieved.
- The LED exhibits slightly different characteristics at different drive currents, which may result in a larger variation of performance (meaning: intensity, wavelength, and forward voltage). Set the application current as close as possible to the test current to minimize these variations.

- The LED is not intended for reverse bias. Use other appropriate components for such purposes. When driving the LED in matrix form, ensure that the reverse bias voltage does not exceed the allowable limit of the LED.
- Avoid rapid changes in ambient temperature, especially in high-humidity environments, because they cause condensation on the LED.
- If the LED is intended to be used in harsh or outdoor environments, protect the LED against damages caused by rain, water, dust, oil, corrosive gases, external mechanical stresses, and so on.

Eye Safety Precautions

LEDs may pose optical hazards when in operation. Do not look directly at operating LEDs because it might be harmful to the eyes. For safety reasons, use appropriate shielding or personal protective equipment.

Disclaimer

Broadcom's products and software are not specifically designed, manufactured, or authorized for sale as parts, components, or assemblies for the planning, construction, maintenance, or direct operation of a nuclear facility or for use in medical devices or applications. The customer is solely responsible, and waives all rights to make claims against Broadcom or its suppliers, for all loss, damage, expense, or liability in connection with such use.

Copyright © 2015–2022 Broadcom. All Rights Reserved. The term “Broadcom” refers to Broadcom Inc. and/or its subsidiaries. For more information, go to www.broadcom.com. All trademarks, trade names, service marks, and logos referenced herein belong to their respective companies.

Broadcom reserves the right to make changes without further notice to any products or data herein to improve reliability, function, or design. Information furnished by Broadcom is believed to be accurate and reliable. However, Broadcom does not assume any liability arising out of the application or use of this information, nor the application or use of any product or circuit described herein, neither does it convey any license under its patent rights nor the rights of others.

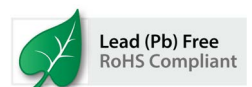

X-ON Electronics

Largest Supplier of Electrical and Electronic Components

Click to view similar products for [LED Displays & Accessories](#) category:

Click to view products by [Broadcom](#) manufacturer:

Other Similar products are found below :

[LTC-2721WC](#) [LTC-4627G](#) [LTC-4627WC](#) [LTD-5021AWC](#) [LTM-8522G](#) [LTS-3361JG-06](#) [ELS-316SYGWA/S530-E2](#) [1668](#) [HT-F196NB-5323](#) [SA03-12EWA](#) [LDQ-N514RI](#) [LDS-A3506RD](#) [LDS-A3926RI](#) [SI-B9T151550WW](#) [SI-B9V171550WW](#) [SLC-3PF-WL](#) [1624](#) [LTC-2621JD](#) [LTC-2623WC](#) [LTC-4624P](#) [LTC-4627JD](#) [LTC-5623JD-20](#) [LTP-1057AHR](#) [LTP-1457AKR](#) [LTP-3784G-01](#) [LTS-4812SKR-P](#) [LTS-6780P](#) [HV-7W30-6829](#) [DA43-11GWA](#) [LDQ-N3402RI](#) [LDQ-N3606RI](#) [LDS-A3924RI-SI](#) [86004CB830](#) [LTP-3862JD](#) [LTP-2088AKD](#) [LTD-6740P](#) [LTC-4727E](#) [LTS-312AY](#) [LTC-2623E](#) [CC25-12YWA](#) [LDM-6432-P3-UR-1](#) [EADSF056RA1](#) [OPS-S3911LY-GW](#) [LDF-U8004BI](#) [SLCN-42M-G](#) [SLCN-42M-W](#) [LTC-3710G](#) [LTS-4801KF](#) [ACSA04-41QWWA/D](#) [LTD-5523ATBZ](#)