

Data Sheet

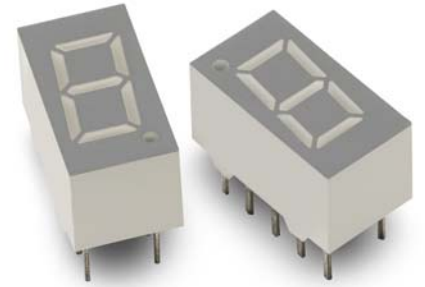

Description

The HDSP-H3x1/H3x3 is a 0.36 inch high, single-digit display series. These halogenated devices utilize AllnGaP red, orange, green and deep red chips. This device is halogenated.

All devices are categorized for luminous intensity. The orange and green devices are categorized for color. Use of similar device categories yields a uniform display.

Features

- High reliability
- Excellent characters appearance
- Available in CA and CC
- RoHS Compliant
- Gray top surface with white diffused segments.

Table 1 Ordering Information

Red	Green	Orange	Deep Red	Description
HDSP-H3E1	HDSP-H3G1	HDSP-H3L1	HDSP-H3A1	Common Anode, Right Hand Decimal
HDSP-H3E3	HDSP-H3G3	HDSP-H3L3	HDSP-H3A3	Common Cathode, Right Hand Decimal

Figure 1 Package Dimension

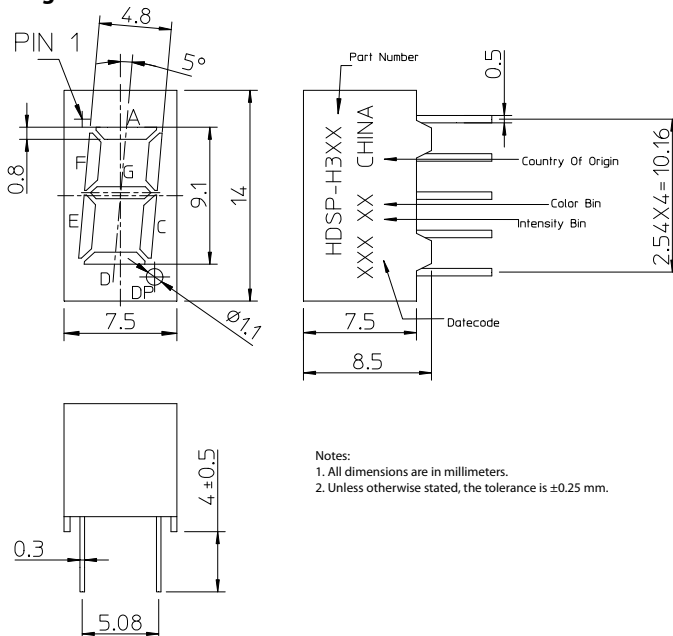

Notes:
 1. All dimensions are in millimeters.
 2. Unless otherwise stated, the tolerance is ±0.25 mm.

Figure 2 Circuit Diagram

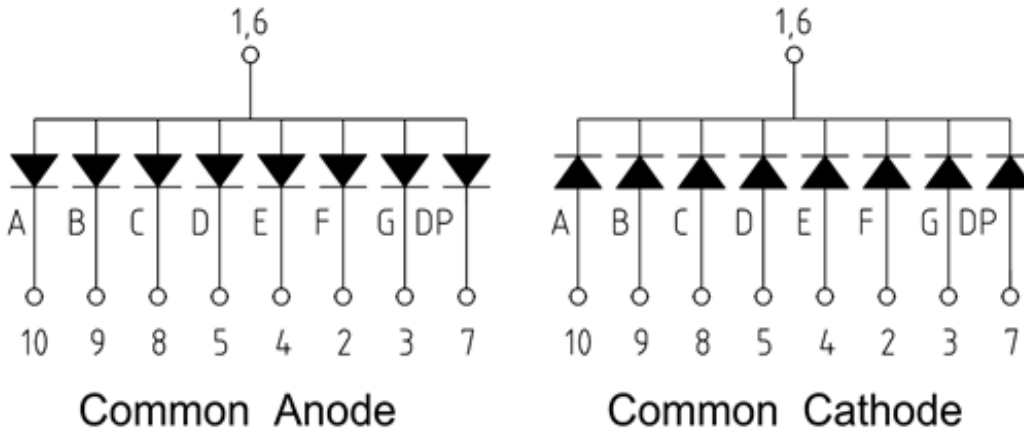

Table 2 Absolute Maximum Ratings at $T_A = 25^\circ\text{C}$

Parameter	Symbol	Red/Orange/Green/Deep Red	Units
Power Dissipation per segment or Dot Point (DP)	P_D	52	mW
Continuous Forward Current per segment	I_F	20	mA
Peak Forward Current per segment (1/10 Duty Cycle, 0.1m sec pulse width)		100	mA
Derating Linearly from 25°C per segment		0.21	mA/ $^\circ\text{C}$
Reverse Voltage per segment or DP	V_R	Not designed for reverse biasing	
Operating Temperature	T_O	-40 to 85	$^\circ\text{C}$
Storage Temperature	T_S	-40 to 85	$^\circ\text{C}$
Wave solder Condition 1.6mm below body		260 $^\circ\text{C}$ peak for 3 secs max	

Table 3 Red Electrical/Optical Characteristics at $T_A = 25^\circ\text{C}$

Parameter	Symbol	Min	Typ	Max	Units	Test Conditions
Average Luminous Intensity (Digit Average)	I_V	—	15	—	mcd	$I_F = 10\text{ mA}$
Peak Wavelength	λ_p	—	634	—	nm	$I_F = 20\text{ mA}$
Dominant Wavelength	λ_d	—	625	—	nm	$I_F = 20\text{ mA}$
Forward Voltage per segment / DP	V_F	—	2.0	2.6	V	$I_F = 20\text{ mA}$
Reverse Current per segment / DP ^a	I_R	—	—	100	μA	$V_R = 5\text{ V}$
Luminous Intensity Matching Ratio (Segment to Segment)	I_{V-M}	—	2:1	—	—	$I_F = 10\text{ mA}$

a. Indicates production go-no-go test only. Long term reverse biasing is not recommended.

Table 4 Green Electrical/Optical Characteristics at $T_A = 25^\circ\text{C}$

Parameter	Symbol	Min	Typ	Max	Units	Test Conditions
Average Luminous Intensity (Digit Average)	I_V	—	5	—	mcd	$I_F = 10\text{ mA}$
Peak Wavelength	λ_p	—	570	—	nm	$I_F = 20\text{ mA}$
Dominant Wavelength	λ_d	—	571	—	nm	$I_F = 20\text{ mA}$
Forward Voltage per segment / DP	V_F	—	2.0	2.6	V	$I_F = 20\text{ mA}$
Reverse Current per segment / DP ^a	I_R	—	—	100	μA	$V_R = 5\text{ V}$
Luminous Intensity Matching Ratio (Segment to Segment)	I_{V-M}	—	2:1	—	—	$I_F = 10\text{ mA}$

a. Indicates production go-no-go test only. Long term reverse biasing is not recommended.

Table 5 Orange Electrical/Optical Characteristics at $T_A = 25^\circ\text{C}$

Parameter	Symbol	Min	Typ	Max	Units	Test Conditions
Average Luminous Intensity (Digit Average)	I_V	—	13	—	mcd	$I_F = 10\text{ mA}$
Peak Wavelength	λ_p	—	610	—	nm	$I_F = 20\text{ mA}$
Dominant Wavelength	λ_d	—	605	—	nm	$I_F = 20\text{ mA}$
Forward Voltage per segment / DP	V_F	—	2.0	2.6	V	$I_F = 20\text{ mA}$
Reverse Current per segment / DP ^a	I_R	—	—	100	μA	$V_R = 5\text{ V}$
Luminous Intensity Matching Ratio (Segment to Segment)	I_{V-M}	—	2:1	—	—	$I_F = 10\text{ mA}$

a. Indicates production go-no-go test only. Long term reverse biasing is not recommended.

Table 6 Deep Red Electrical/Optical Characteristics at $T_A = 25^\circ\text{C}$

Parameter	Symbol	Min	Typ	Max	Units	Test Conditions
Average Luminous Intensity (Digit Average)	I_V	—	12	—	mcd	$I_F = 10\text{ mA}$
Peak Wavelength	λ_p	—	644	—	nm	$I_F = 20\text{ mA}$
Dominant Wavelength	λ_d	—	635	—	nm	$I_F = 20\text{ mA}$
Forward Voltage per segment / DP	V_F	—	2.0	2.6	V	$I_F = 20\text{ mA}$
Reverse Current per segment / DP ^a	I_R	—	—	100	μA	5 V
Luminous Intensity Matching Ratio (Segment to Segment)	I_{V-M}	—	2:1	—	—	$I_F = 10\text{ mA}$

a. Indicates production go-no-go test only. Long term reverse biasing is not recommended.

Red

Figure 3 Relative Luminous Intensity Vs Forward Current

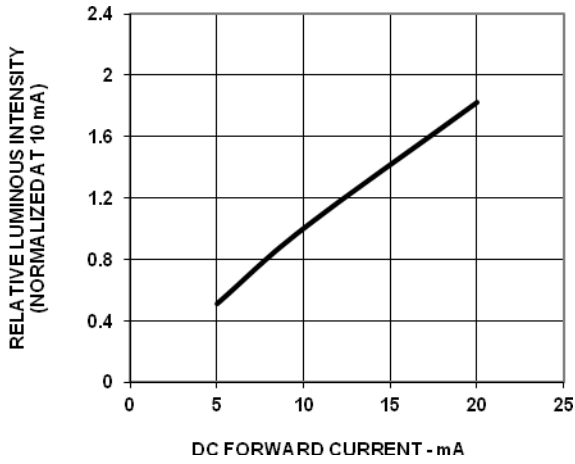

Figure 4 Forward Voltage Vs Current

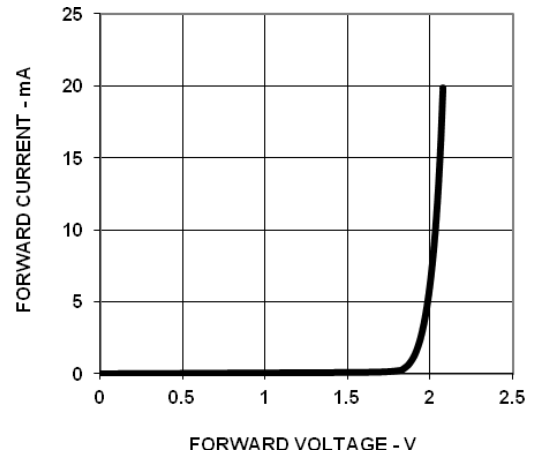
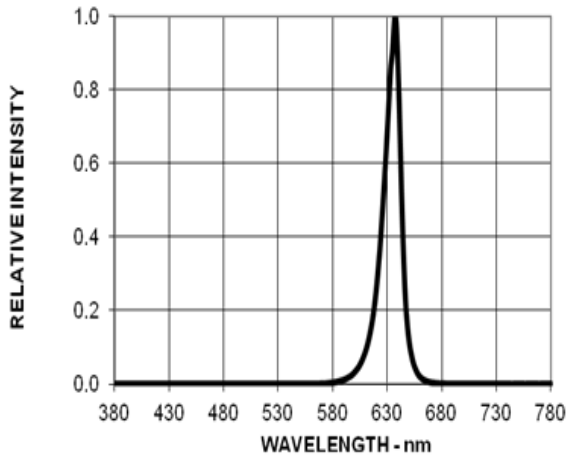

Figure 5 Relative Luminous Intensity Vs Wavelength



Green

Figure 6 Relative Luminous Intensity Vs Forward Current

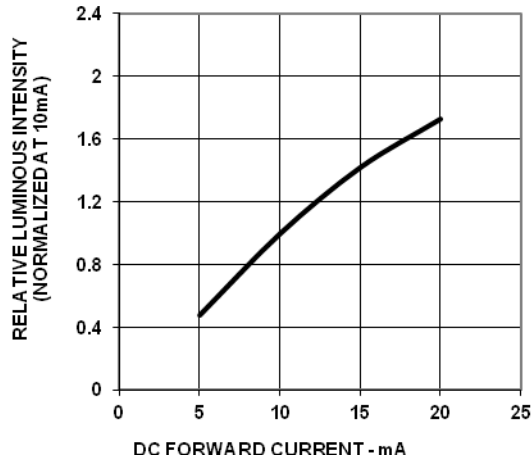

Figure 7 Forward Voltage Vs Current

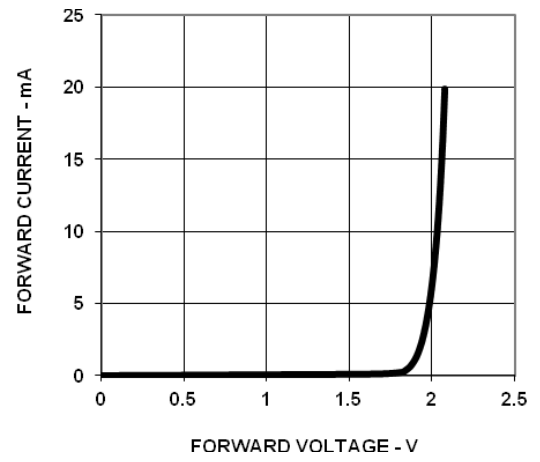
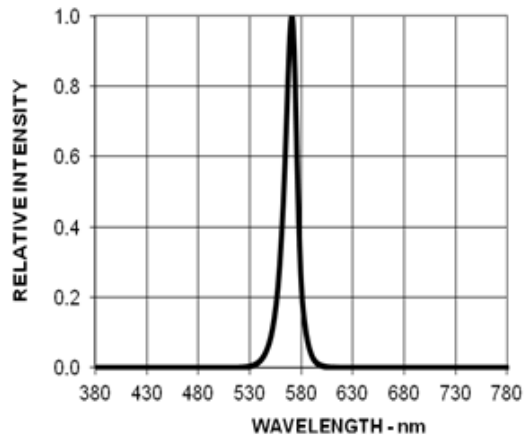

Figure 8 Relative Luminous Intensity Vs Wavelength



Orange

Figure 9 Relative Luminous Intensity Vs Forward Current

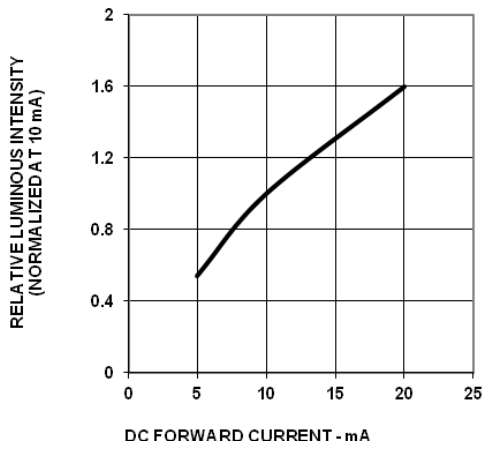

Figure 10 Forward Voltage Vs Current

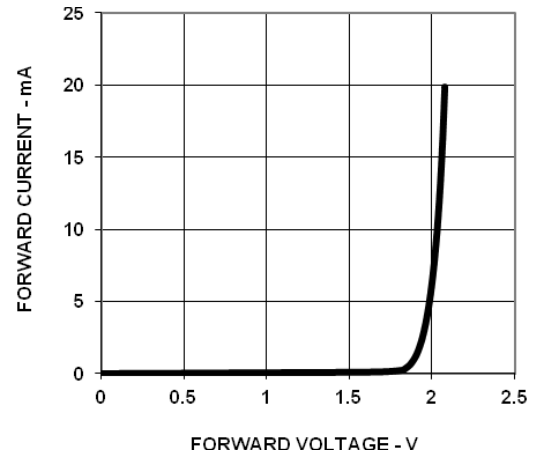
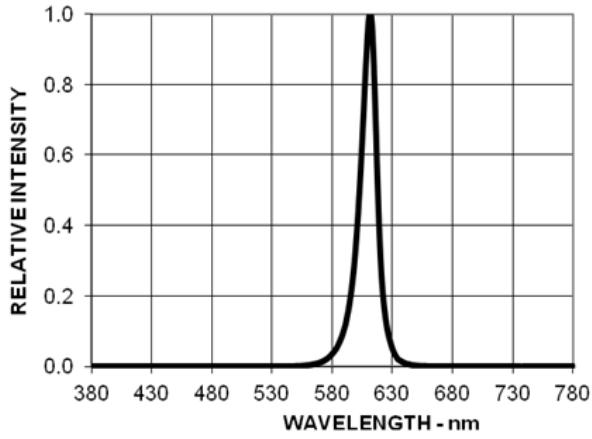

Figure 11 Relative Luminous Intensity Vs Wavelength



Deep Red

Figure 12 Relative Luminous Intensity Vs Forward Current

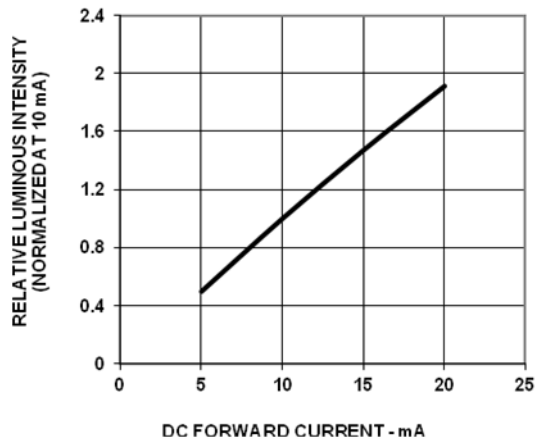

Figure 13 Forward Voltage Vs Current

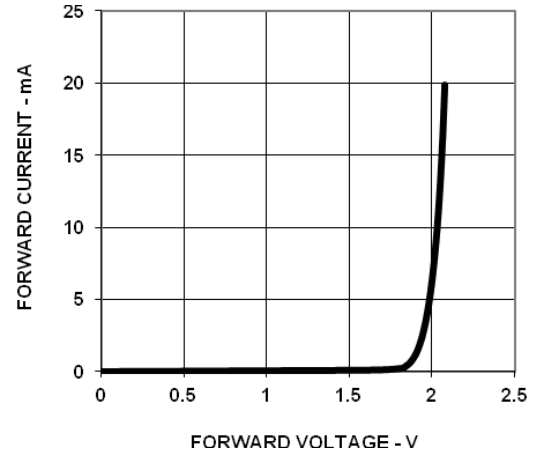
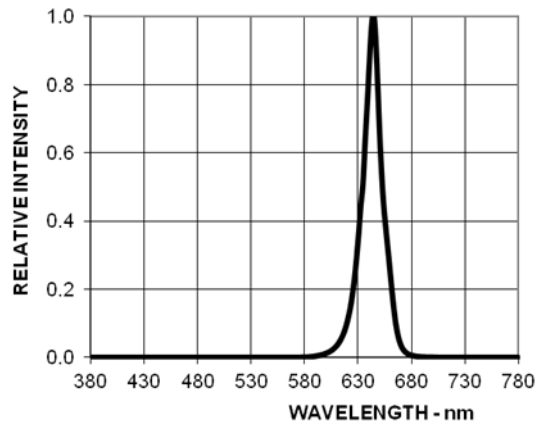
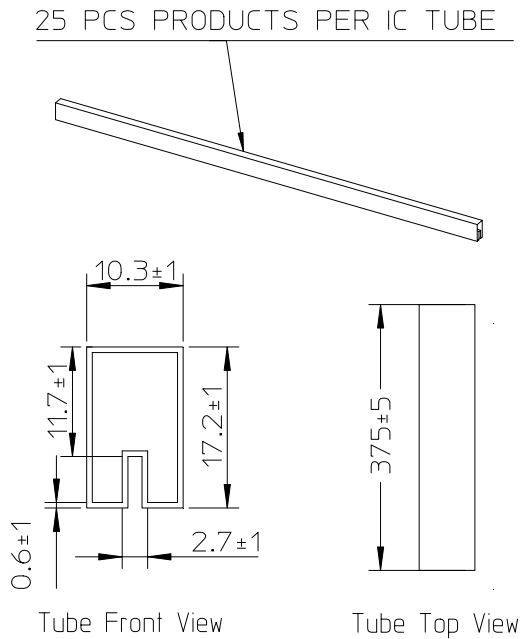

Figure 14 Relative Luminous Intensity Vs Wavelength



Packing Tube Specifications



Reference

For further information on soldering LEDs, please refer to Avago Technologies Application Note 1027.

For product information and a complete list of distributors, please go to our web site:

www.avagotech.com

Avago Technologies and the A logo are trademarks of Avago Technologies in the United States and other countries. All other brand and product names may be trademarks of their respective companies.

Data subject to change. Copyright © 2015 Avago Technologies. All Rights Reserved.

pub-005311 – December 16, 2015

AVAGO
TECHNOLOGIES

X-ON Electronics

Largest Supplier of Electrical and Electronic Components

Click to view similar products for [LED Displays & Accessories](#) category:

Click to view products by [Broadcom](#) manufacturer:

Other Similar products are found below :

[LTC-2721WC](#) [LTC-4624JD](#) [LTC-4627WC](#) [LTC-571P](#) [LTD-5021AWC](#) [LTM-8522G](#) [LTP-4323P](#) [LTP-747G](#) [LTS-3361JG-06](#) [ELS-316SYGWA/S530-E2](#) [1668](#) [HT-F196NB-5323](#) [IPD2131-27](#) [LDQ-N514RI](#) [LDS-A3506RD](#) [LDS-A3926RI](#) [SC03-12HDB](#) [SI-B9T151550WW](#) [SI-B9V171550WW](#) [SLC-3PF-WL](#) [SLDN-32M-G](#) [1624](#) [LTC-2623WC](#) [LTC-4627JD](#) [LTD-322G](#) [LTD-482PC](#) [LTP-1057AHR](#) [LTP-1457AKR](#) [LTP-3784G-01](#) [LTS-313AP](#) [LTS-4812SKR-P](#) [LTS-547AE](#) [LTS-6780P](#) [446010401-3](#) [HV-7W30-6829](#) [DA43-11GWA](#) [LDD-A516RI-17](#) [LDD-E305RI](#) [LDQ-N3402RI](#) [LDQ-N3606RI](#) [LDT-M2804RI](#) [86004CB830](#) [LTP-3862JD](#) [LTP-2088AKD](#) [LTD-6740P](#) [LTS-6880Y](#) [LDS-SMC3002RISUGTR](#) [LTC-2623E](#) [CC25-12YWA](#) [LDM-6432-P3-UR-1](#)