

HLMP-AG74/75, HLMP-AM74/75, HLMP-AB74/75

Red, Green, and Blue 5 mm Mini Oval LEDs

Description

These Precision Optical Performance Oval LEDs are specifically designed for full color/video and passenger information signs. The oval-shaped radiation pattern and high luminous intensity ensure that these devices are excellent for wide field of view outdoor applications where a wide viewing angle and readability in sunlight are essential. The package epoxy contains a UV inhibitor to reduce the effects of long-term exposure to direct sunlight.

Features

- Well-defined spatial radiation pattern
- High-brightness material
- Available in red, green, and blue colors
 - Red – AlInGaP, 626 nm
 - Green – InGaN, 530 nm
 - Blue – InGaN, 470 nm
- Superior resistance to moisture
- Standoff and non-standoff package
- Tinted and diffused
- Typical viewing angle 30° × 70°

Applications

- Full-color signs
- Gas price signs

CAUTION! InGaN devices are Class 1C HBM ESD sensitive per JEDEC Standard. Please observe appropriate precautions during handling and processing. Refer to Application Note AN-1142 for additional details.

Figure 1: Package Dimensions

Package Drawing A

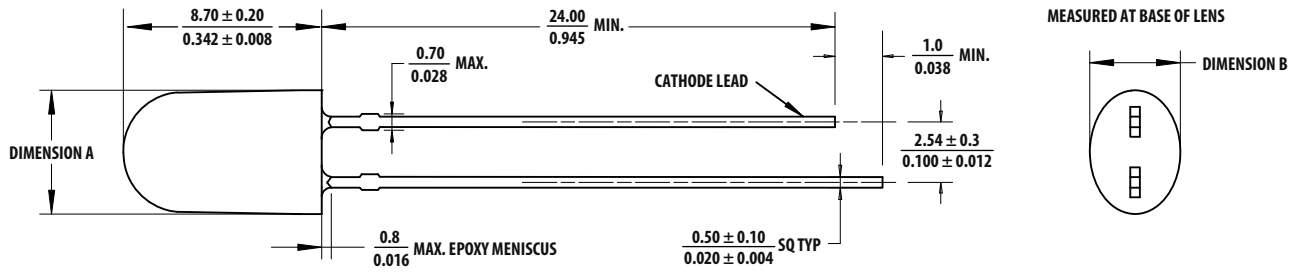

Package Drawing B

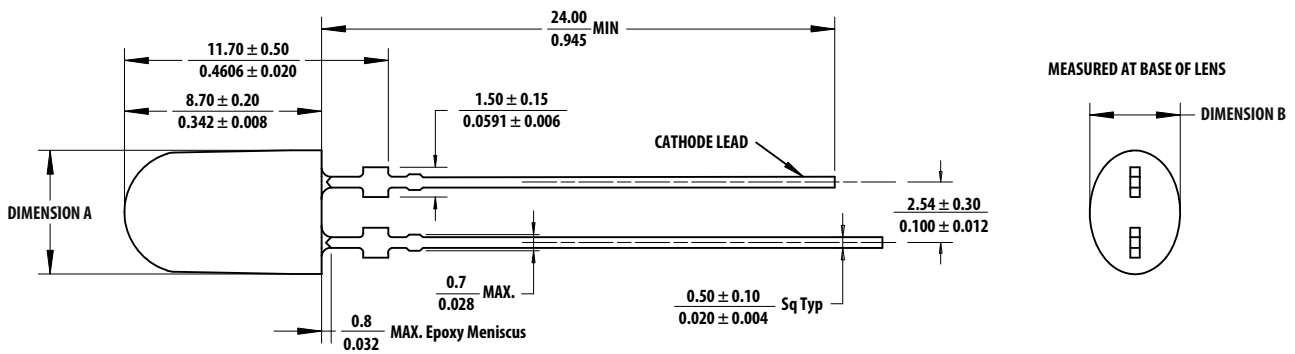

Part Number	Parameter	
	Dimension A	Dimension B
HLMP-AG74/75	5.30 ± 0.20 0.209 ± 0.008	3.90 ± 0.20 0.154 ± 0.008
HLMP-AM74/75	5.40 ± 0.20	3.90 ± 0.20
HLMP-AB74/75	0.213 ± 0.008	0.150 ± 0.008

Device Selection Guide

Part Number	Color and Dominant Wavelength λ_d (nm) Typ. ^a	Luminous Intensity I _v (mcd) at 20 mA ^{b, c, d}		Typical Viewing Angle (°) ^e	Standoff	Package Drawing
		Min.	Max.			
HLMP-AG74-120DD	Red 626	2900	4200	30° × 70°	No	A
HLMP-AG75-120DD	Red 626	2900	4200		Yes	B
HLMP-AM74-56BDD	Green 530	6050	8710		No	A
HLMP-AM74-56CDD	Green 530	6050	8710		No	A
HLMP-AM75-56BDD	Green 530	6050	8710		Yes	B
HLMP-AM75-56CDD	Green 530	6050	8710		Yes	B
HLMP-AB74-WXBDD	Blue 470	1380	1990		No	A
HLMP-AB74-WXCDD	Blue 470	1380	1990		No	A
HLMP-AB75-WXBDD	Blue 470	1380	1990		Yes	B
HLMP-AB75-WXCDD	Blue 470	1380	1990		Yes	B

- Dominant wavelength, λ_d , is derived from the CIE Chromaticity Diagram and represents the color of the lamp.
- The luminous intensity is measured on the mechanical axis of the lamp package and it is tested with pulsing condition.
- The optical axis is closely aligned with the package mechanical axis.
- Tolerance for each bin limit is $\pm 15\%$.
- $\theta_{1/2}$ is the off-axis angle where the luminous intensity is half the on-axis intensity.

Absolute Maximum Ratings

$T_J = 25^\circ\text{C}$

Parameter	Red	Green/Blue	Units
DC Forward Current ^a	50	30	mA
Peak Forward Current	100 ^b	100 ^c	mA
Power Dissipation	120	114	mW
LED Junction Temperature	130	110	°C
Operating Temperature Range	-40 to +100	-40 to +85	°C
Storage Temperature Range	-40 to +100		°C

- Derate linearly as shown in [Figure 5](#) and [Figure 9](#).
- Duty factor 30%, frequency 1 kHz.
- Duty factor 10%, frequency 1 kHz.

Electrical/Optical Characteristics

$T_J = 25^\circ\text{C}$

Parameter	Symbol	Min.	Typ.	Max.	Units	Test Conditions
Forward Voltage Red Green Blue	V_F	1.8 2.8 2.8	2.1 3.2 3.2	2.4 3.8 3.8	V	$I_F = 20\text{ mA}$
Reverse Voltage ^a Red Green and Blue	V_R	5 5	— —	— —	V	$I_R = 100\ \mu\text{A}$ $I_R = 10\ \mu\text{A}$
Dominant Wavelength ^b Red Green Blue	λ_d	618 523 464	626 530 470	630 535 476	nm	$I_F = 20\text{ mA}$
Peak Wavelength Red Green Blue	λ_{PEAK}	— — —	634 521 464	— — —	nm	Peak of Wavelength of Spectral Distribution at $I_F = 20\text{ mA}$
Thermal Resistance	$R\theta_{\text{J-PIN}}$	—	240 °	—	C/W	LED Junction-to-Pin
Luminous Efficacy ^c Red Green Blue	η_V	— — —	218 538 65	— — —	lm/W	Emitted Luminous Power/ Emitted Radiant Power

- Indicates product final testing condition. Long-term reverse bias is not recommended.
- The dominant wavelength is derived from the Chromaticity Diagram and represents the color of the lamp.
- The radiant intensity, I_e in watts per steradian, may be found from the equation $I_e = I_V/\eta_V$ where I_V is the luminous intensity in candelas and η_V is the luminous efficacy in lumens/watt.

Part Numbering System

H L M P -

x ₁	x ₂	x ₃	x ₄
----------------	----------------	----------------	----------------

 -

x ₅	x ₆	x ₇	x ₈	x ₉
----------------	----------------	----------------	----------------	----------------

Number	Description	Option	
x ₁	Package type	A	5-mm Mini Oval 30° × 70°
x ₂	Color	B	Blue
		G	Red
		M	Green
x ₃ x ₄	Lead standoff	74	Without lead standoffs
		75	With lead standoffs
x ₅	Minimum intensity bin	Refer to the Device Selection Guide	
x ₆	Maximum intensity bin	Refer to the Device Selection Guide	
x ₇	Color bin selection	0	Full range
		B	Color bin 2 and bin 3
		C	Color bin 3 and bin 4
x ₈ x ₉	Packaging option	DD	Ammopack

NOTE: Refer to AB 5337 for complete information about the part numbering system.

Intensity Bin Limit Table (1.2: 1 Iv Bin Ratio)

Bin ID	Intensity (mcd) at 20 mA	
	Min.	Max.
W	1380	1660
X	1660	1990
Y	1990	2400
Z	2400	2900
1	2900	3500
2	3500	4200
3	4200	5040
4	5040	6050
5	6050	7260
6	7260	8710

Tolerance for each bin limit is $\pm 15\%$

VF Bin Table (V at 20 mA)

Bin ID	Min.	Max.
VD	1.8	2.0
VA	2.0	2.2
VB	2.2	2.4

NOTE:

1. Tolerance for each bin limit is ± 0.05 V.
2. V_F binning only applicable to the Red color.

Red Color Range

Min. Dom.	Max. Dom.					
618.0	630.0	x	0.6872	0.3126	0.6890	0.2943
		y	0.6690	0.3149	0.7080	0.2920

Blue Color Bin Table

Bin	Min. Dom.	Max. Dom.					
2	464	468	x	0.1374	0.1766	0.1699	0.1291
			y	0.0374	0.0966	0.1062	0.0495
3	468	472	x	0.1291	0.1699	0.1616	0.1187
			y	0.0495	0.1062	0.1209	0.0671
4	472	476	x	0.1187	0.1616	0.1517	0.1063
			y	0.0671	0.1209	0.1423	0.0945

Tolerance for each bin limit is ± 0.5 nm.

Green Color Bin Table

Bin	Min. Dom.	Max. Dom.					
2	523	527	x	0.0979	0.145	0.1711	0.1305
			y	0.8316	0.7319	0.7218	0.8189
3	527	531	x	0.1305	0.1711	0.1967	0.1625
			y	0.8189	0.7218	0.7077	0.8012
4	531	535	x	0.1625	0.1967	0.221	0.1929
			y	0.8012	0.7077	0.692	0.7816

Tolerance for each bin limit is ± 0.5 nm.

NOTE: All bin categories are established for the classification of products. Products may not be available in all bin categories. Contact your Broadcom® representative for further information.

AllnGaP Red

Figure 2: Relative Intensity vs. Wavelength

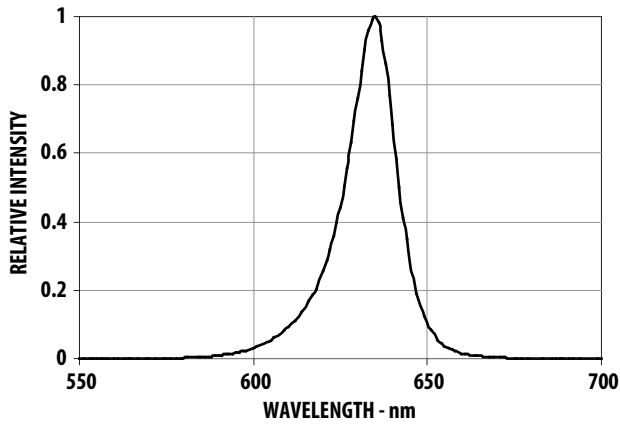

Figure 3: Forward Current vs. Forward Voltage

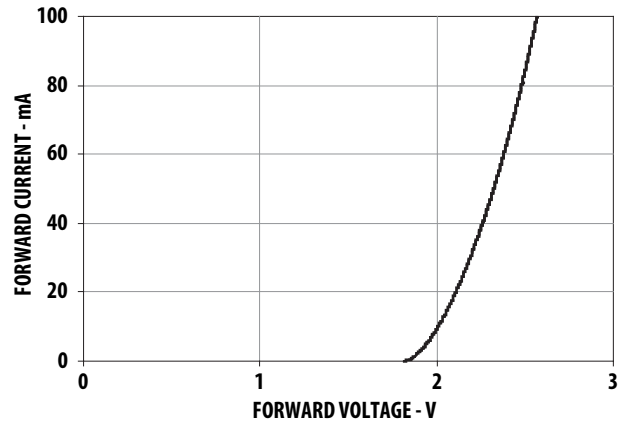

Figure 4: Relative Intensity vs. Forward Current

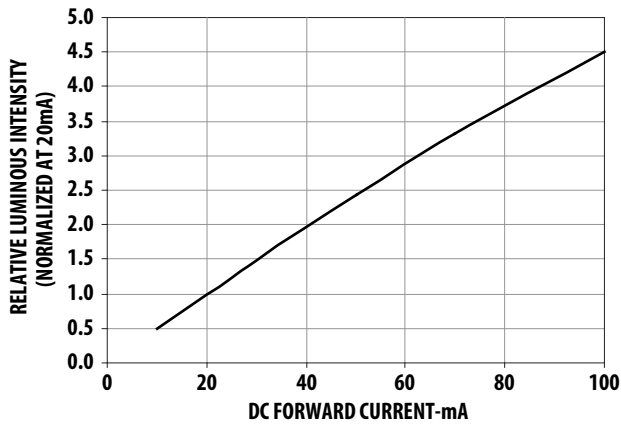
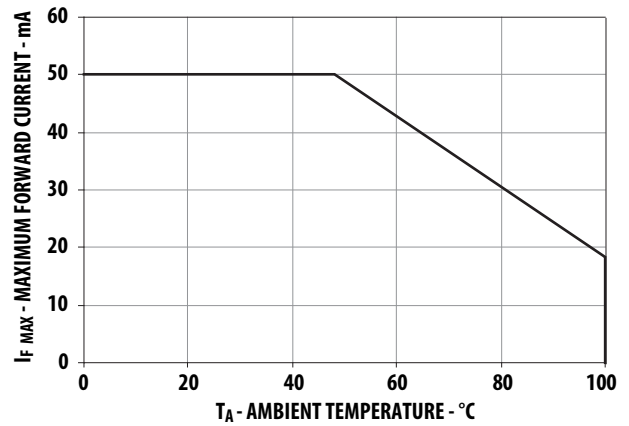

Figure 5: Maximum Forward Current vs. Ambient Temperature



InGaN Green and Blue

Figure 6: Relative Intensity vs. Wavelength

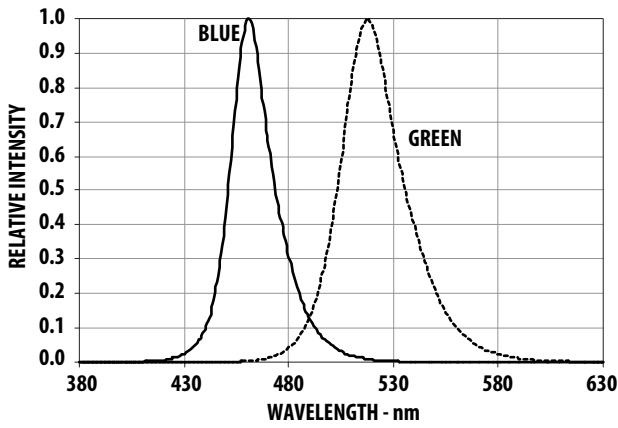

Figure 7: Forward Current vs. Forward Voltage

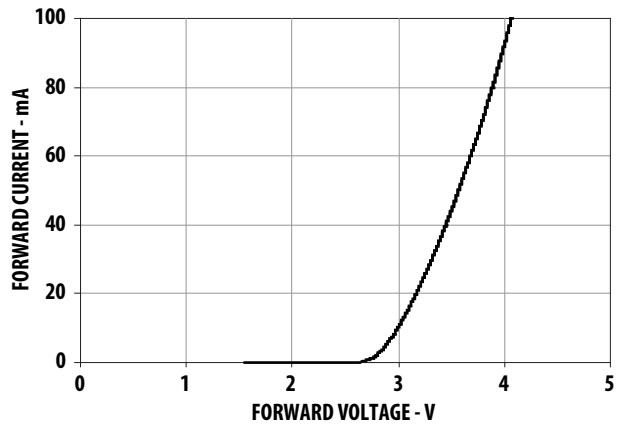

Figure 8: Relative Intensity vs. Forward Current

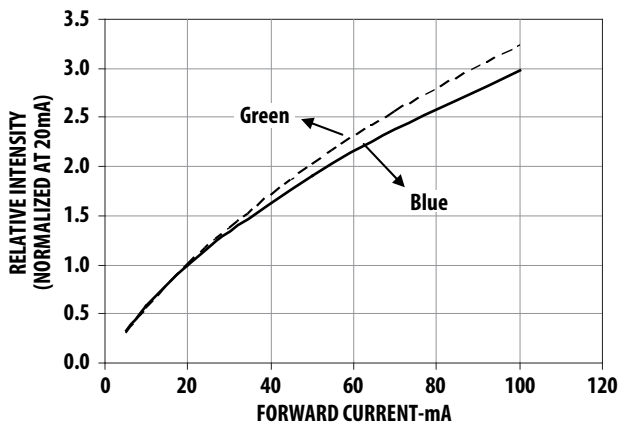

Figure 9: Maximum Forward Current vs. Ambient Temperature

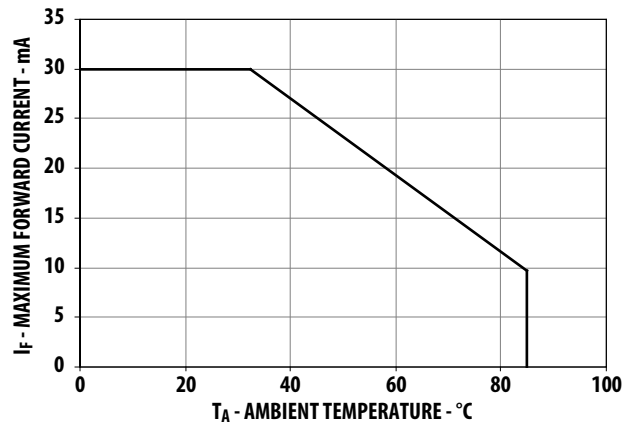

Figure 10: Relative Dominant Wavelength vs. Forward Current

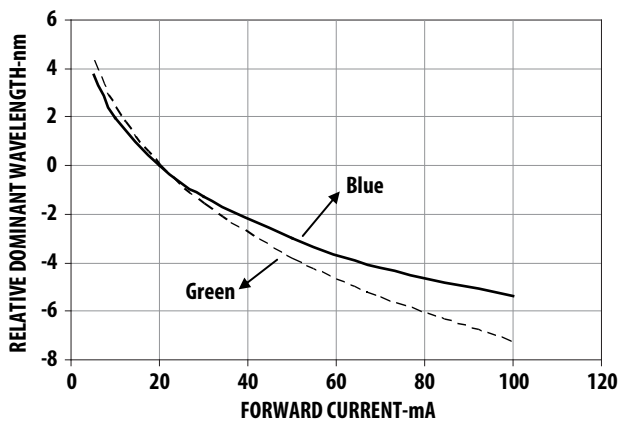

Figure 11: Radiation Pattern-Major Axis

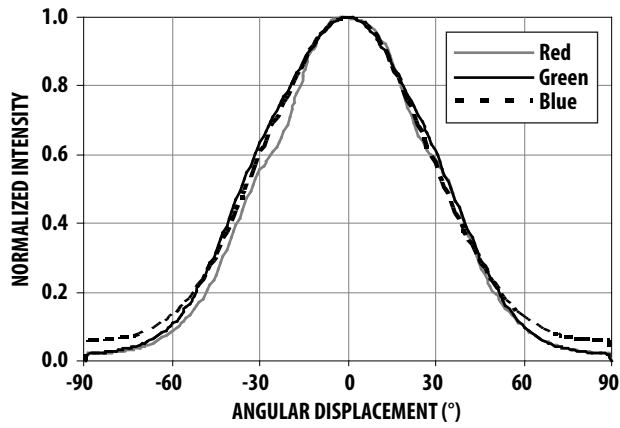

Figure 12: Radiation Pattern-Minor Axis

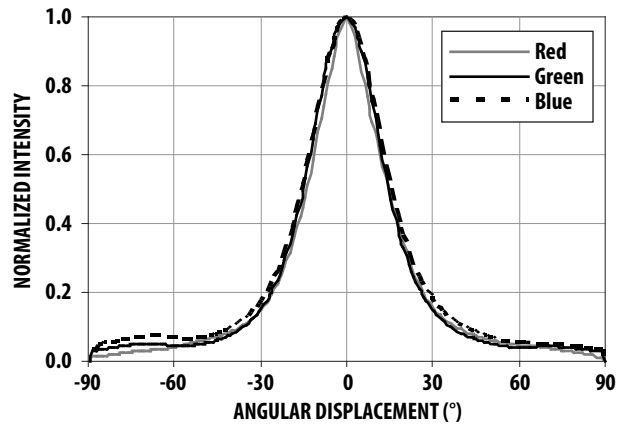

Figure 13: Relative Light Output vs. Junction Temperature

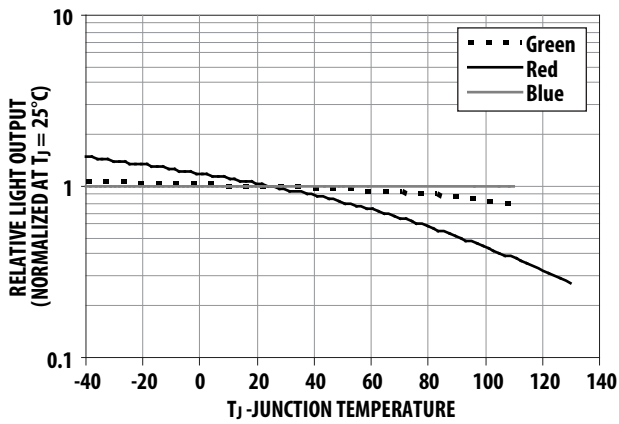
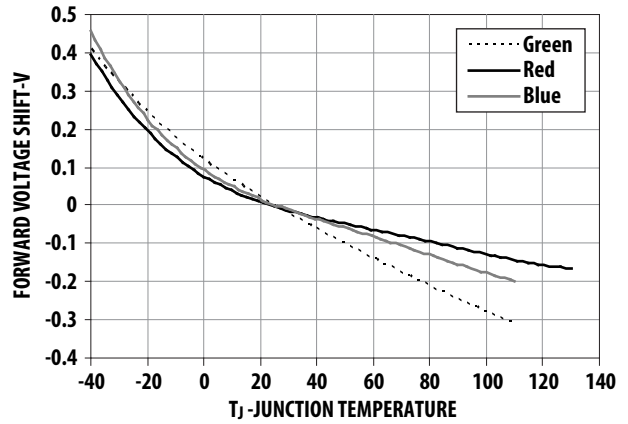

Figure 14: Forward Voltage Shift vs. Junction Temperature



Precautions

Lead Forming

- The leads of an LED lamp may be preformed or cut to length prior to the insertion and soldering on the PC board.
- For better control, use the proper tool to precisely form and cut the leads to the applicable length rather than doing it manually.
- If manual lead cutting is necessary, cut the leads after the soldering process. The solder connection forms a mechanical ground that prevents mechanical stress due to lead cutting from traveling into LED package. Use this method for the hand soldering operation, because the excess lead length also acts as a small heat sink.

Soldering and Handling

- Take care during the PCB assembly and soldering process to prevent damage to the LED component.
- The LED component may be effectively hand soldered to the PCB. However, it is only recommended under unavoidable circumstances, such as rework. The closest manual soldering distance of the soldering heat source (the soldering iron's tip) to the body is 1.59 mm. Soldering the LED using a soldering iron tip closer than 1.59 mm might damage the LED.

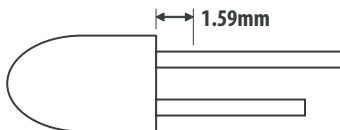

- Apply ESD precautions on the soldering station and personnel to prevent ESD damage to the LED component, which is ESD sensitive. Refer to Broadcom application note AN-1142 for details. The soldering iron used should have grounded tip to ensure electrostatic charge is properly grounded.

- Recommended soldering conditions follow.

	Wave Soldering ^{a, b}	Manual Solder Dipping
Preheat temperature	105°C max.	—
Preheat time	60s max.	—
Peak temperature	260°C max.	260°C max.
Dwell time	5s max.	5s max.

- The preceding conditions refer to measurements with a thermocouple mounted at the bottom of the PCB.
- Use only the bottom preheaters to reduce thermal stress experienced by the LED.

- Set and maintain wave soldering parameters according to the recommended temperature and dwell time. The customer is advised to perform a daily check on the soldering profile to ensure that it conforms to he recommended soldering conditions.

Broadcom LED Configuration

Figure 15: LED Configuration

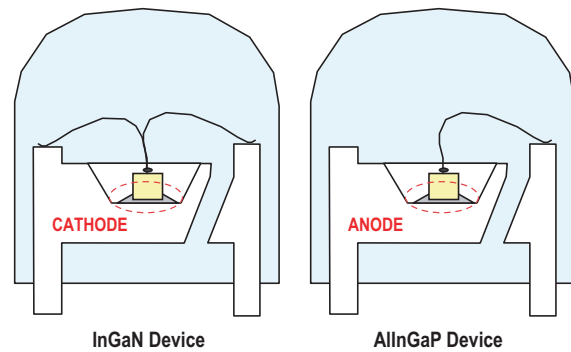

- Any alignment fixture that is being applied during wave soldering should be loosely fitted and should not have weight or force applied on the LED. Use non-metal material because it absorbs less heat during the wave soldering process.
- At elevated temperatures, the LED is more susceptible to mechanical stress. Therefore, the PCB must allowed to cool down to room temperature prior to handling, which includes removal of the alignment fixture or pallet.

- If the PCB board contains both through-hole (TH) LEDs and other surface-mount components, solder the surface mount components on the top side of the PCB. If surface mount must be on the bottom side, solder these components using reflow soldering prior to the insertion of the TH LED.
- The recommended PC board plated through-holes (PTH) sizes for the LED component leads follows.

- Oversizing the PTH can lead to a twisted LED after clinching. Under sizing the PTH can cause difficulty with inserting the TH LED.

Refer to application note AN5334 for more information about soldering and handling of high-brightness TH LED lamps.

LED Component Lead Size	Diagonal	Plated Through-Hole Diameter
0.45 × 0.45 mm (0.018 × 0.018 in.)	0.636 mm (0.025 in.)	0.98 to 1.08 mm (0.039 to 0.043 in.)
0.50 × 0.50 mm (0.020 × 0.020 in.)	0.707 mm (0.028 in.)	1.05 to 1.15 mm (0.041 to 0.045 in.)

Figure 16: Example of Wave Soldering Temperature Profile for TH LED

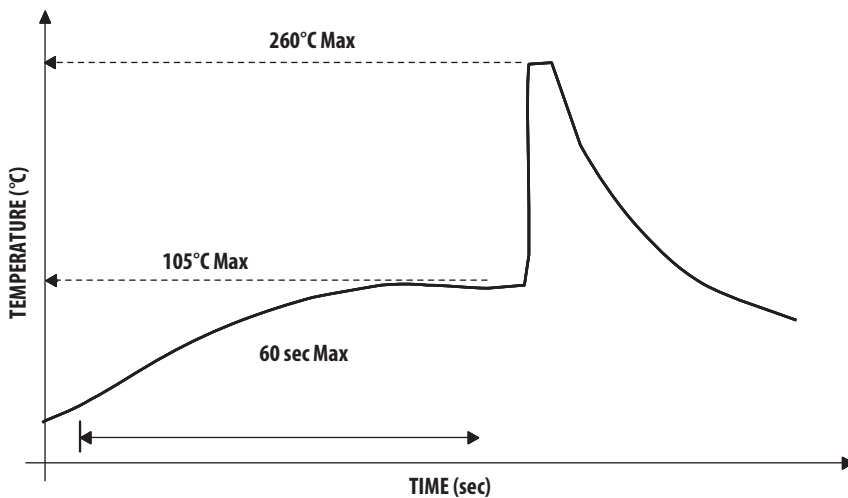

Recommended solder:
 Sn63 (Leaded solder alloy)
 SAC305 (Lead free solder alloy)

Flux: Rosin flux

Solder bath temperature: 255°C ± 5°C
 (maximum peak temperature = 260°C)

Dwell time: 3.0 sec - 5.0 sec
 (maximum = 5sec)

Note: Allow for board to be sufficiently cooled to room temperature before exerting mechanical force.

Figure 17: Ammo Packs Drawing

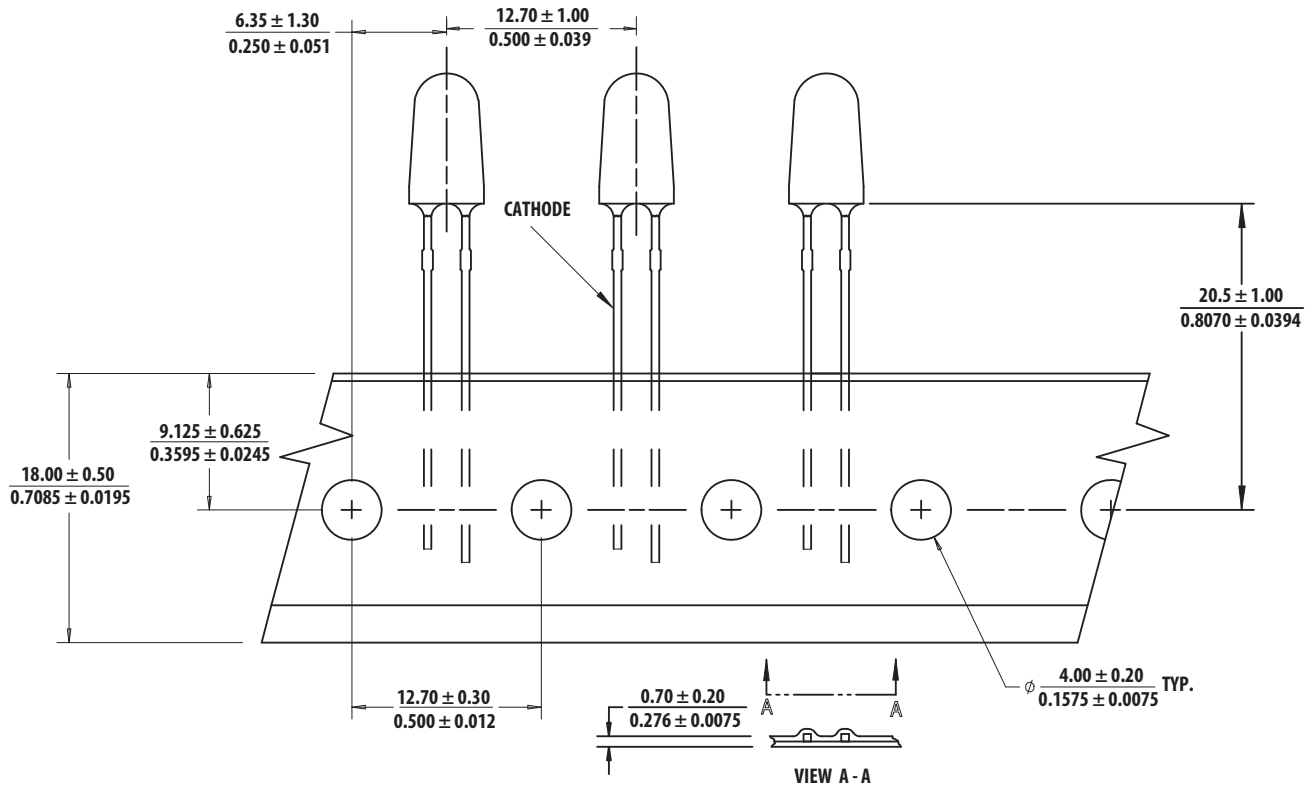

NOTE: All dimensions are in millimeters (inches).

Figure 18: Packaging Box for Ammo Packs

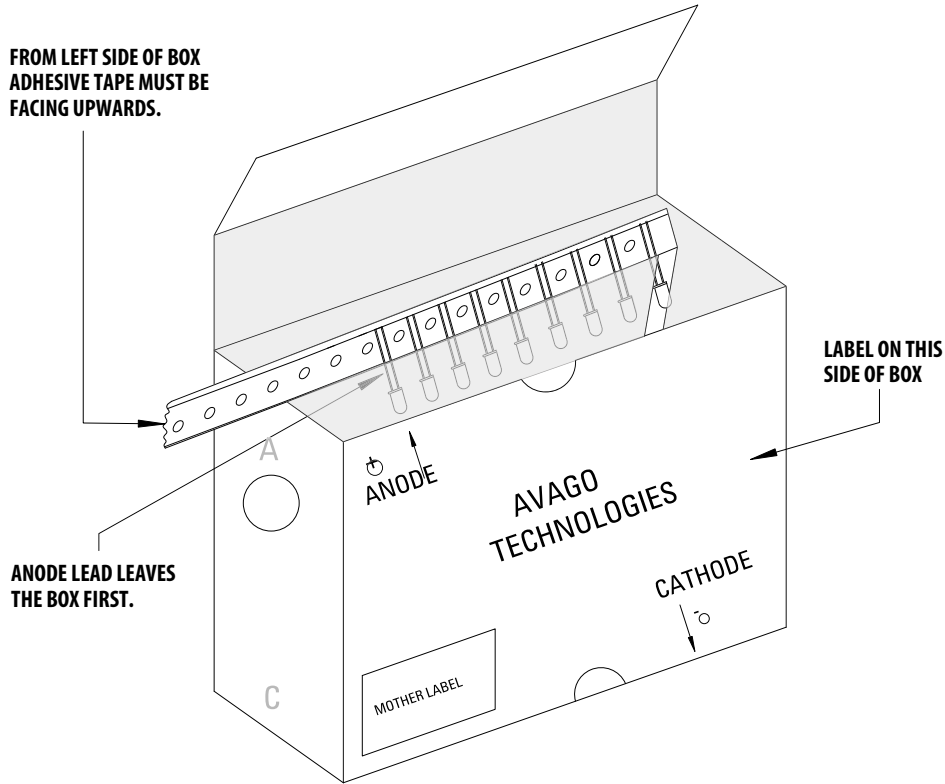







NOTE: For InGaN devices, the ammo pack packaging box contains an ESD logo.

Packaging Label

Figure 19: Mother Label (Available on the packaging box of ammo pack and shipping box.)

AVAGO TECHNOLOGIES	
(1P) Item: Part Number 	STANDARD LABEL LS0002 RoHS Compliant e3 max temp 260C
(1T) Lot: Lot Number 	(Q) QTY: Quantity 
LPN: 	CAT: Intensity Bin 
(9D)MFG Date: Manufacturing Date 	BIN: Refer to below information
<hr/>	
(P) Customer Item: 	
(V) Vendor ID: 	(9D) Date Code: Date Code 
<hr/>	
DeptID: 	Made In: Country of Origin 

Figure 20: Baby Label (Only available on bulk packaging.)

AVAGO TECHNOLOGIES	
Lamps Baby Label	
RoHS Compliant e3 max temp 260C	
(1P) PART #: Part Number 	
(1T) LOT #: Lot Number 	
(9D)MFG DATE: Manufacturing Date 	QUANTITY: Packing Quantity 
<hr/>	
C/O: Country of Origin	
Customer P/N: 	CAT: Intensity Bin 
Supplier Code: 	BIN: Refer to below information 
	DATECODE: Date Code 

Acronyms and Definitions

BIN

- The color bin only or VF bin only (applicable for part numbers with color bins but without VF bin *or* part numbers with VF bins and no color bin)
or
- The color bin is incorporated with the VF bin (applicable for the part number that has both color bins and VF bins).

Example

- Color bin only or VF bin only
BIN: 2 (represents color bin 2 only)
BIN: VB (represents VF bin "VB" only)
- Color bin incorporate with VF bin
BIN: **2 VB**
where:
 - **2**: Color bin 2 only
 - **VB**: VF bin "VB"

Disclaimer

Broadcom's products and software are not specifically designed, manufactured, or authorized for sale as parts, components, or assemblies for the planning, construction, maintenance, or direct operation of a nuclear facility or for use in medical devices or applications. The customer is solely responsible, and waives all rights to make claims against Broadcom or its suppliers, for all loss, damage, expense, or liability in connection with such use.

Broadcom, the pulse logo, Connecting everything, Avago Technologies, Avago, and the A logo are among the trademarks of Broadcom and/or its affiliates in the United States, certain other countries, and/or the EU.

Copyright © 2011–2018 Broadcom. All Rights Reserved.

The term “Broadcom” refers to Broadcom Inc. and/or its subsidiaries. For more information, please visit www.broadcom.com.

Broadcom reserves the right to make changes without further notice to any products or data herein to improve reliability, function, or design. Information furnished by Broadcom is believed to be accurate and reliable. However, Broadcom does not assume any liability arising out of the application or use of this information, nor the application or use of any product or circuit described herein, neither does it convey any license under its patent rights nor the rights of others.



X-ON Electronics

Largest Supplier of Electrical and Electronic Components

Click to view similar products for [Standard LEDs - Through Hole category](#):

Click to view products by [Broadcom manufacturer](#):

Other Similar products are found below :

[LTL-10234W](#) [LTL-10254W](#) [LTL-1214A](#) [LTL-2231AT](#) [LTL-3251A](#) [LTL-4262N](#) [LTL-433P](#) [LTL-5234](#) [LTL87HTBK](#) [LTW-87HD4B](#)
[HLMP-3507-D00B1](#) [HLMP-EL30-PS0DD](#) [1L0532V23G0TD001](#) [NSPW500CS](#) [NTE30036](#) [NTE30044](#) [NTE30059](#) [NTE3020](#) [LD CQDP-](#)
[1U3U-W5-1-K](#) [LO566UHR3-70G-A3](#) [LP379PPG1C0G0300001](#) [SLX-LX3044GD](#) [SLX-LX3044ID](#) [SLX-LX3044YD](#) [1.90690.3330000](#) [SSS-](#)
[LX4673ID-410B](#) [1L0532Y24I0TD001](#) [264-7SYGD/S530-E2](#) [HLMP1385](#) [LTL-10224W](#) [LTL-1224A](#) [LTL-1234A](#) [LTL-1BEHJ-012](#) [LTL-](#)
[2251AT](#) [LTL-307YE-012](#) [LTL-403HR](#) [LTL-4222](#) [LU7-E-B](#) [4380H1](#) [TLHY44K1L2](#) [HLMP-3962-F0002](#) [HLMP-GG15-R0000](#) [323-](#)
[2SURD/S530-A3](#) [L53SRC/E-Z](#) [L-7679C1ZGC](#) [4302T1-5V](#) [4306D23](#) [4363D1/5](#) [WP1503SRC/J4](#) [WP153GDT](#)