

# HLMP-EL55/EG55/EL57/EH57/ED57

## T-1<sup>3</sup>/<sub>4</sub> (5 mm) Precision Optical Performance AllnGaP LED Lamps



### Data Sheet



Lead (Pb) Free  
RoHS 6 fully  
compliant



#### Description

These Precision Optical Performance AllnGaP LEDs provide superior light output for excellent readability in sunlight and are extremely reliable. AllnGaP LED technology provides extremely stable light output over long periods of time. Precision Optical Performance lamps utilize the aluminum indium gallium phosphide (AllnGaP) technology.

These LED lamps are tinted, diffused, T-1<sup>3</sup>/<sub>4</sub> packages incorporating second generation optics producing well defined radiation patterns at specific viewing cone angles.

There are two families of amber, red, and red-orange lamps; AllnGaP and the higher performance AllnGaP II.

The high maximum LED junction temperature limit of +130°C enables high temperature operation in bright sunlight conditions.

These lamps are available in two package options to give the designer flexibility with device mounting.

#### Benefits

- Viewing angles match traffic management sign requirements
- Colors meet automotive specifications
- Superior performance in outdoor environments
- Suitable for autoinsertion onto PC boards

#### Features

- Well defined and smooth spatial radiation patterns
- Wide viewing angle
- Tinted diffused lamp
- High luminous output
- Colors:
  - 590/592 nm Amber
  - 617 nm Reddish-Orange
  - 626/630 nm Red
- High operating temperature: T<sub>JLED</sub> = +130°C
- Superior resistance to moisture

#### Applications

- Traffic management:
  - Variable message signs
  - Traffic management signs
- Commercial indoor/outdoor advertising:
  - Signs
  - Marquees
  - Passenger information
- Automotive:
  - Exterior and interior lights

## Part Numbering System

HLMP - X X XX - X X X XX

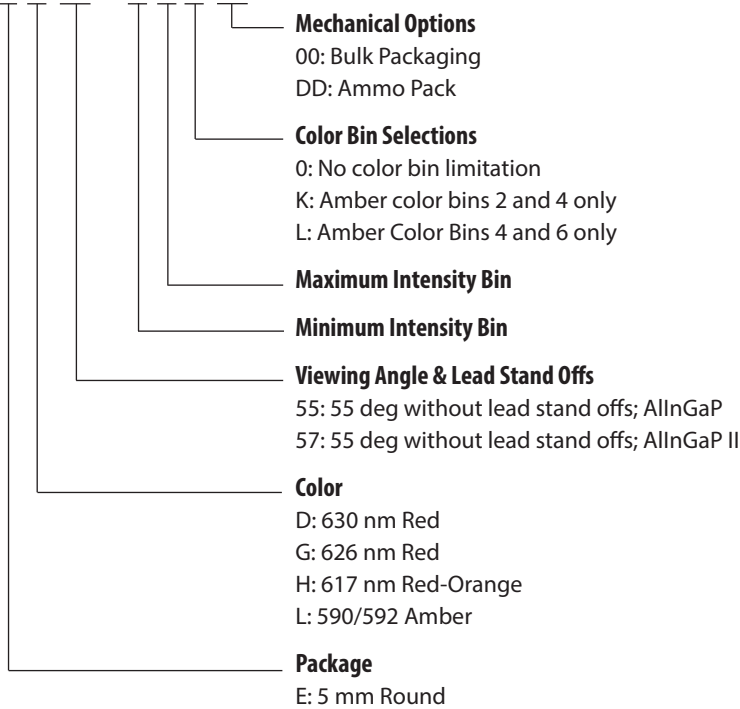

## Device Selection Guide for AllnGaP

Part Number	Color and Dominant Wavelength $\lambda_d$ (nm) Typ. [3]	Luminous Intensity I <sub>v</sub> (mcd) at 20 mA Min. [1,2]	Luminous Intensity I <sub>v</sub> (mcd) at 20 mA Max. [1,2]
HLMP-EL55-GK0DD	Amber 590	140	400
HLMP-EL55-GHKDD	Amber 590	140	240
HLMP-EL55-HJKxx	Amber 590	180	310
HLMP-EL55-JKLDD	Amber 590	240	400
HLMP-EL55-LP000	Amber 590	400	1150
HLMP-EG55-GK0DD	Red 626	140	400
HLMP-EG55-HJ0xx	Red 626	180	310
HLMP-EG55-JK0xx	Red 626	240	400

## Device Selection Guide for AllnGaP II

Part Number	Color and Dominant Wavelength $\lambda_d$ (nm) Typ. [3]	Luminous Intensity I <sub>v</sub> (mcd) at 20 mA Min. [1,2]	Luminous Intensity I <sub>v</sub> (mcd) at 20 mA Max. [1,2]
HLMP-EL57-LP0xx	Amber 592	400	1150
HLMP-EH57-LP000	Red-Orange 617	400	1150
HLMP-ED57-LP0xx	Red 630	400	1150
HLMP-ED57-LPT00	Red 630	400	1150

### Notes:

1. The luminous intensity is measured on the mechanical axis of the lamp package.
2. The optical axis is closely aligned with the package mechanical axis.
3. The dominant wavelength,  $\lambda_d$ , is derived from the CIE Chromaticity Diagram and represents the color of the lamp.

## Package Dimensions

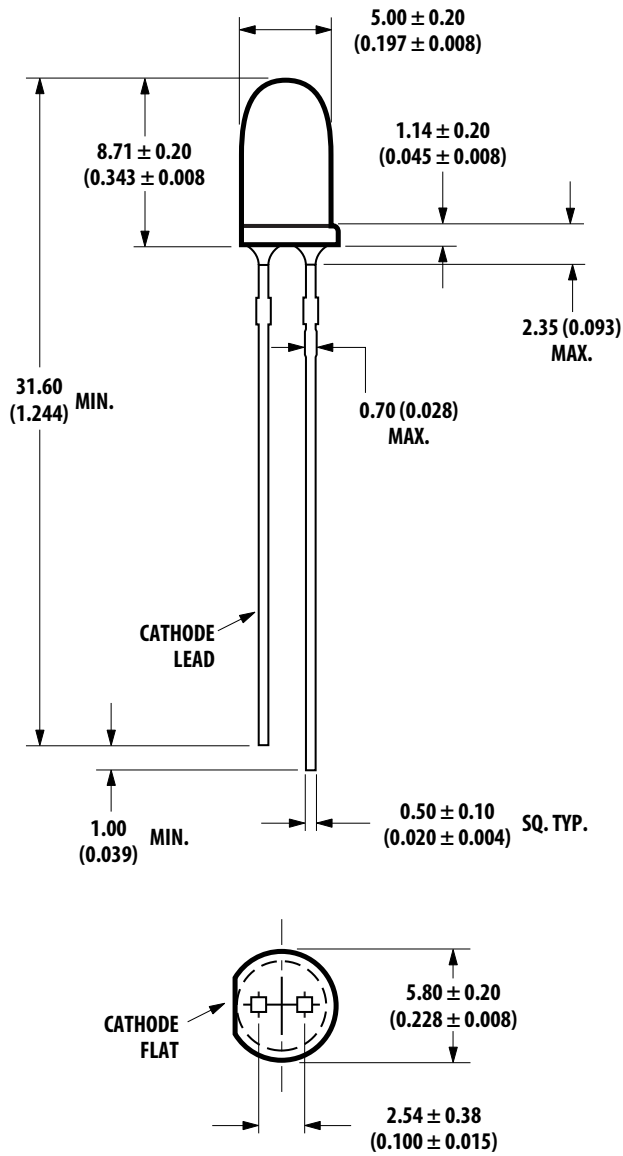

### NOTES:

1. ALL DIMENSIONS ARE IN MILLIMETERS (INCHES).
2. TAPERS SHOWN AT TOP OF LEADS (BOTTOM OF LAMP PACKAGE) INDICATE AN EPOXY MENISCUS THAT MAY EXTEND ABOUT 1 mm (0.040 in.) DOWN THE LEADS.
3. RECOMMENDED PC BOARD HOLE DIAMETERS:  
LAMP PACKAGE WITHOUT STAND-OFFS: FLUSH MOUNTING AT BASE OF LAMP PACKAGE = 1.143/1.067 (0.044/0.042).

### Absolute Maximum Ratings at $T_A = 25^\circ\text{C}$

DC Forward Current <sup>[1,2,3]</sup> .....	50 mA
Peak Pulsed Forward Current <sup>[2,3]</sup> .....	100 mA
Average Forward Current <sup>[3]</sup> .....	30 mA
Reverse Voltage ( $I_R = 100 \mu\text{A}$ ).....	5 V
LED Junction Temperature.....	130°C
Operating Temperature .....	-40°C to +100°C
Storage Temperature .....	-40°C to +100°C

#### Notes:

1. Derate linearly as shown in Figure 4.
2. For long term performance with minimal light output degradation, drive currents between 10 mA and 30 mA are recommended. For more information on recommended drive conditions, please refer to Application Brief I-024 (5966-3087E).
3. Please contact your Avago Technologies sales representative about operating currents below 10 mA.

### Electrical/Optical Characteristics at $T_A = 25^\circ\text{C}$

Parameter	Symbol	Min.	Typ.	Max.	Units	Test Conditions
Forward Voltage	$V_F$				V	$I_F = 20 \text{ mA}$
Amber ( $\lambda_d = 590 \text{ nm}$ )			2.02	2.4		
Amber ( $\lambda_d = 592 \text{ nm}$ )			2.15	2.4		
Red-Orange ( $\lambda_d = 617 \text{ nm}$ )			2.08	2.4		
Red ( $\lambda_d = 626 \text{ nm}$ )			1.90	2.4		
Red ( $\lambda_d = 630 \text{ nm}$ )			2.00	2.4		
Reverse Voltage	$V_R$	5	20		V	$I_R = 100 \mu\text{A}$
Peak Wavelength	$\lambda_{\text{PEAK}}$				nm	Peak of Wavelength of Spectral Distribution at $I_F = 20 \text{ mA}$
Amber ( $\lambda_d = 590 \text{ nm}$ )			592			
Amber ( $\lambda_d = 592 \text{ nm}$ )			594			
Red-Orange ( $\lambda_d = 617 \text{ nm}$ )			623			
Red ( $\lambda_d = 626 \text{ nm}$ )			635			
Red ( $\lambda_d = 630 \text{ nm}$ )			639			
Spectral Halfwidth	$\Delta\lambda_{1/2}$		17		nm	Wavelength Width at Spectral Distribution $1/2$ Power Point at $I_F = 20 \text{ mA}$
Speed of Response	$\tau_s$		20		ns	Exponential Time Constant, $e^{-t/\tau_s}$
Capacitance	C		40		pF	$V_F = 0, f = 1 \text{ MHz}$
Thermal Resistance	$R\theta_{\text{J-PIN}}$		240		$^\circ\text{C/W}$	LED Junction-to-Cathode Lead
Luminous Efficacy <sup>[1]</sup>	$\eta_V$				lm/W	Emitted Luminous Power/Emitted Radiant Power
Amber ( $\lambda_d = 590 \text{ nm}$ )			480			
Amber ( $\lambda_d = 592 \text{ nm}$ )			500			
Red-Orange ( $\lambda_d = 617 \text{ nm}$ )			235			
Red ( $\lambda_d = 626 \text{ nm}$ )			150			
Red ( $\lambda_d = 630 \text{ nm}$ )			155			

#### Note:

1. The radiant intensity,  $I_e$ , in watts per steradian, may be found from the equation  $I_e = I_v/\eta_V$ , where  $I_v$  is the luminous intensity in candelas and  $\eta_V$  is the luminous efficacy in lumens/watt.

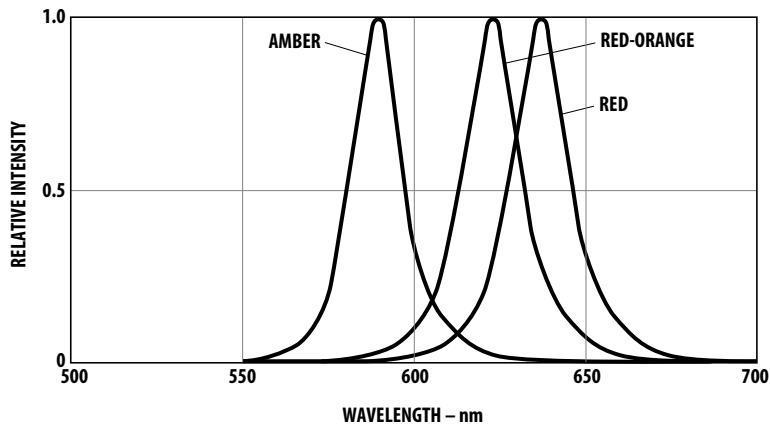

Figure 1. Relative intensity vs. peak wavelength.

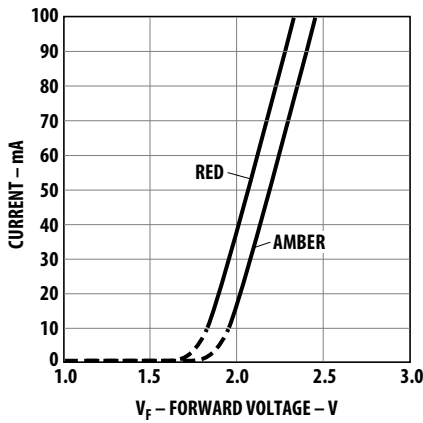

Figure 2. Forward current vs. forward voltage.

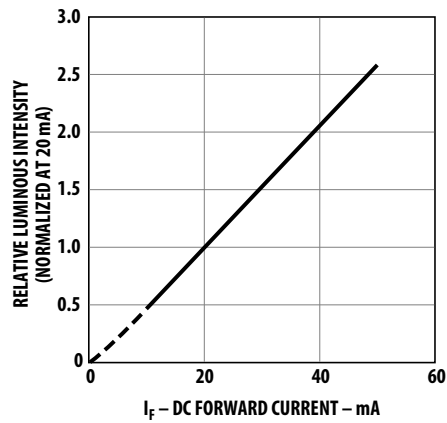

Figure 3. Relative luminous intensity vs. forward current.

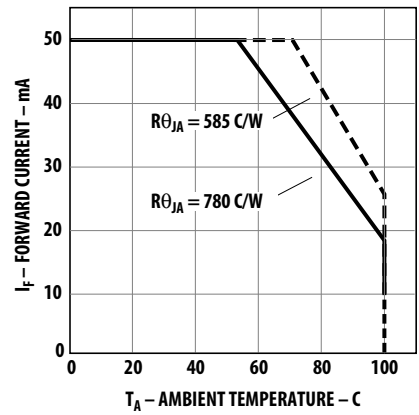

Figure 4. Maximum forward current vs. ambient temperature. Derating based on  $T_{JMAX} = 130^\circ\text{C}$ .

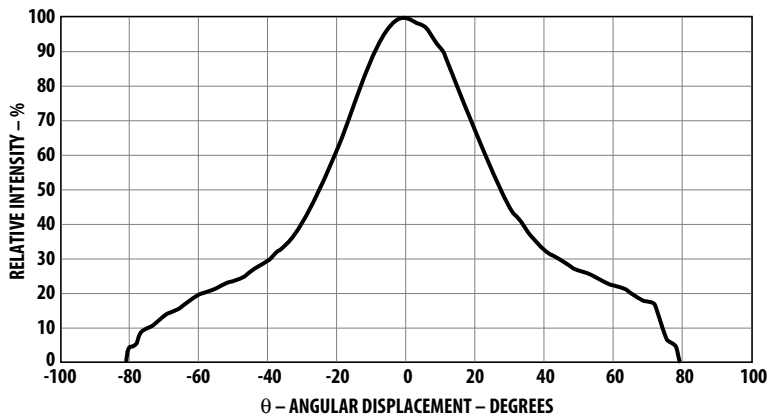

Figure 5. Representative spatial radiation pattern for 55° viewing angle lamps.

**Intensity Bin Limits  
(mcd at 20 mA)**

<b>Bin Name</b>	<b>Min.</b>	<b>Max.</b>
G	140	180
H	180	240
J	240	310
K	310	400
L	400	520
M	520	680
N	680	880
P	880	1150

Tolerance for each bin limit is  $\pm 15\%$ .

**Amber Color Bin Limits  
(nm at 20 mA)**

<b>Bin Name</b>	<b>Min.</b>	<b>Max.</b>
1	584.5	587.0
2	587.0	589.5
4	589.5	592.0
6	592.0	594.5

Tolerance for each bin limit is  $\pm 0.5$  nm.

**Note:**

1. Bin categories are established for classification of products. Products may not be available in all bin categories.

## Precautions:

### Lead Forming:

- The leads of an LED lamp may be preformed or cut to length prior to insertion and soldering on PC board.
- For better control, it is recommended to use proper tool to precisely form and cut the leads to applicable length rather than doing it manually.
- If manual lead cutting is necessary, cut the leads after the soldering process. The solder connection forms a mechanical ground which prevents mechanical stress due to lead cutting from traveling into LED package. This is highly recommended for hand solder operation, as the excess lead length also acts as small heat sink.

### Soldering and Handling:

- Care must be taken during PCB assembly and soldering process to prevent damage to the LED component.
- LED component may be effectively hand soldered to PCB. However, it is only recommended under unavoidable circumstances such as rework. The closest manual soldering distance of the soldering heat source (soldering iron's tip) to the body is 1.59mm.

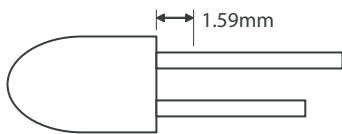

Soldering the LED using soldering iron tip closer than 1.59mm might damage the LED.

- ESD precaution must be properly applied on the soldering station and personnel to prevent ESD damage to the LED component that is ESD sensitive. Do refer to Avago application note AN 1142 for details. The soldering iron used should have grounded tip to ensure electrostatic charge is properly grounded.
- Recommended soldering condition:

	Wave Soldering [1, 2]	Manual Solder Dipping
Pre-heat temperature	105 °C Max.	-
Preheat time	60 sec Max	-
Peak temperature	250 °C Max.	260 °C Max.
Dwell time	3 sec Max.	5 sec Max

Note:

- 1) Above conditions refers to measurement with thermocouple mounted at the bottom of PCB.
  - 2) It is recommended to use only bottom preheaters in order to reduce thermal stress experienced by LED.
- Wave soldering parameters must be set and maintained according to the recommended temperature and dwell time. Customer is advised to perform daily check on the soldering profile to ensure that it is always conforming to recommended soldering conditions.

Note:

1. PCB with different size and design (component density) will have different heat mass (heat capacity). This might cause a change in temperature experienced by the board if same wave soldering setting is used. So, it is recommended to re-calibrate the soldering profile again before loading a new type of PCB.
2. Avago Technologies' high brightness LED are using high efficiency LED die with single wire bond as shown below. Customer is advised to take extra precaution during wave soldering to ensure that the maximum wave temperature does not exceed 250°C and the solder contact time does not exceeding 3sec. Over-stressing the LED during soldering process might cause premature failure to the LED due to delamination.

### Avago Technologies LED configuration

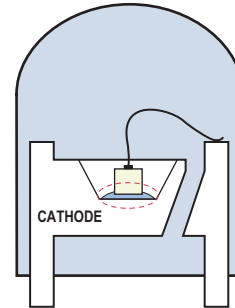

Note: Electrical connection between bottom surface of LED die and the lead frame is achieved through conductive paste.

- Any alignment fixture that is being applied during wave soldering should be loosely fitted and should not apply weight or force on LED. Non metal material is recommended as it will absorb less heat during wave soldering process.
- At elevated temperature, LED is more susceptible to mechanical stress. Therefore, PCB must allowed to cool down to room temperature prior to handling, which includes removal of alignment fixture or pallet.
- If PCB board contains both through hole (TH) LED and other surface mount components, it is recommended that surface mount components be soldered on the top side of the PCB. If surface mount need to be on the bottom side, these components should be soldered using reflow soldering prior to insertion the TH LED.
- Recommended PC board plated through holes (PTH) size for LED component leads.

LED component lead size	Diagonal	Plated through hole diameter
0.45 x 0.45 mm (0.018x 0.018 inch)	0.636 mm (0.025 inch)	0.98 to 1.08 mm (0.039 to 0.043 inch)
0.50 x 0.50 mm (0.020x 0.020 inch)	0.707 mm (0.028 inch)	1.05 to 1.15 mm (0.041 to 0.045 inch)

- Over-sizing the PTH can lead to twisted LED after clinching. On the other hand under sizing the PTH can cause difficulty inserting the TH LED.

Refer to application note AN5334 for more information about soldering and handling of high brightness TH LED lamps.

**Example of Wave Soldering Temperature Profile for TH LED**

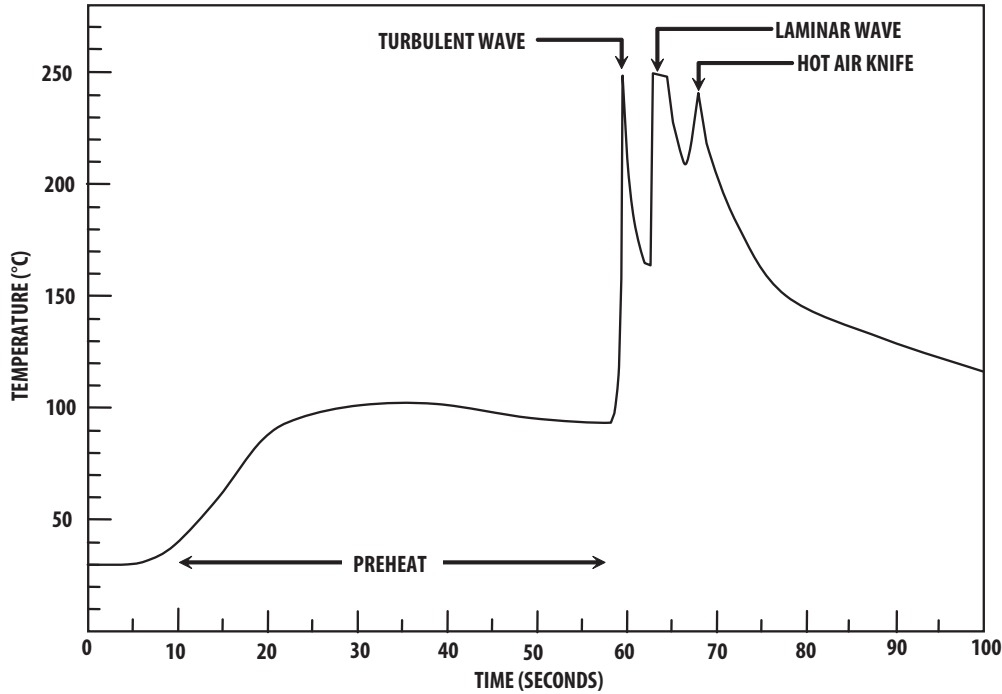

Recommended solder:  
 Sn63 (Leaded solder alloy)  
 SAC305 (Lead free solder alloy)

Flux: Rosin flux

Solder bath temperature:  
 245°C ± 5°C (maximum peak  
 temperature = 250°C)

Dwell time: 1.5 sec - 3.0 sec  
 (maximum = 3sec)

Note: Allow for board to be  
 sufficiently cooled to room  
 temperature before exerting  
 mechanical force.

**Ammo Pack Drawing**

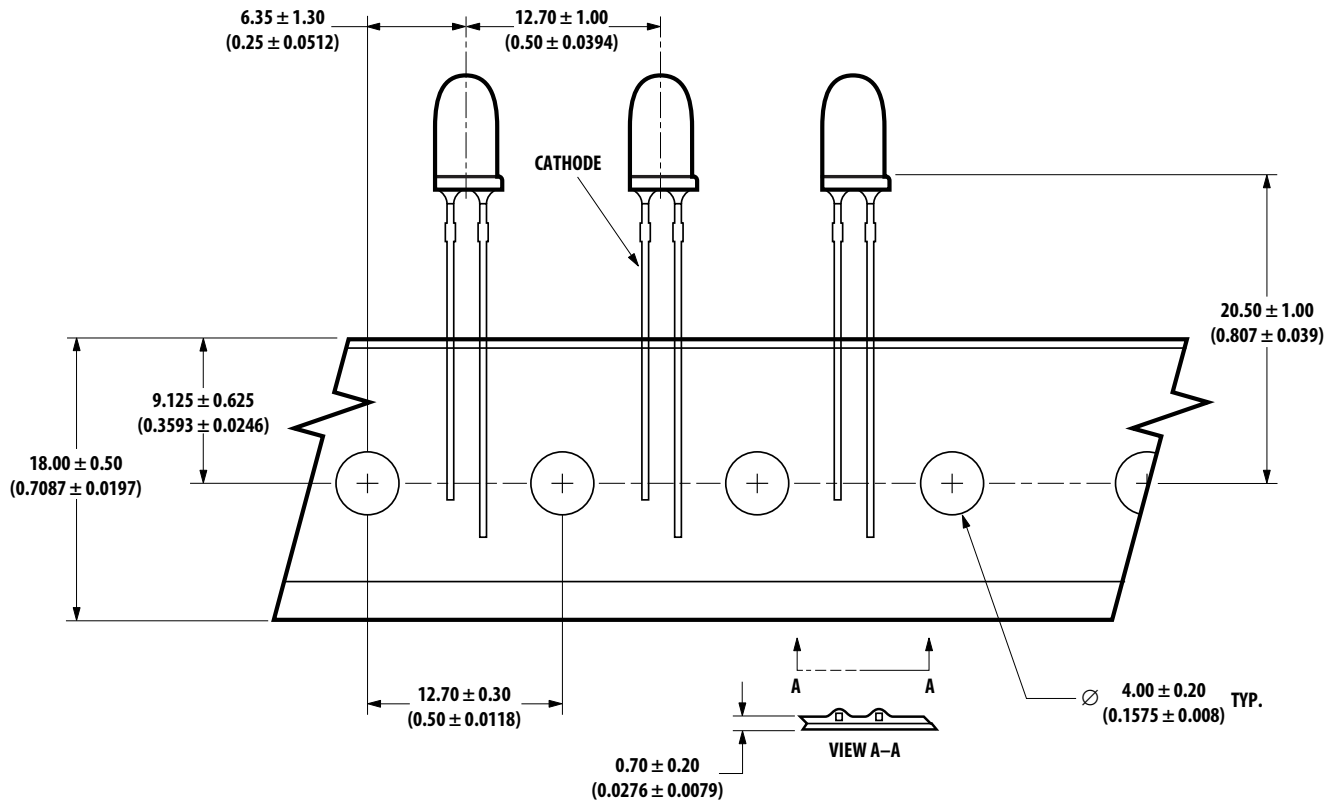

ALL DIMENSIONS IN MILLIMETERS (INCHES).

NOTE: THE AMMO-PACKS DRAWING IS APPLICABLE FOR PACKAGING OPTION -DD & -ZZ AND REGARDLESS OF STANDOFF OR NON-STANDOFF.



## Packaging Box for Ammo Packs

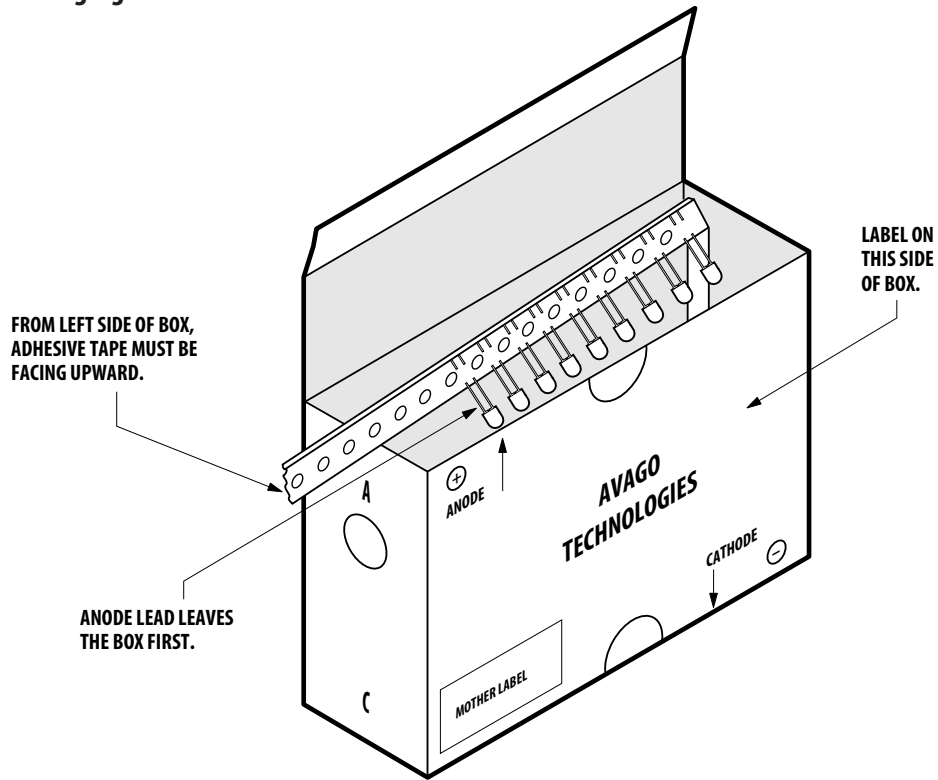











NOTE: THE DIMENSION FOR AMMO PACK IS APPLICABLE FOR THE DEVICE WITH STANDOFF AND WITHOUT STANDOFF.

## Packaging Label:

(i) Avago Mother Label: (Available on packaging box of ammo pack and shipping box)

<p>(1P) Item: <b>Part Number</b>  </p>		<p><b>Avago</b>          TECHNOLOGIES          STANDARD LABEL LS0002          RoHS Compliant          e3 max temp 250C</p>
<p>(1T) Lot: <b>Lot Number</b>  </p>	<p>(Q) QTY: <b>Quantity</b>  </p>	
<p>LPN:  </p>	<p>CAT: <b>Intensity Bin</b>  </p>	
<p>(9D)MFG Date: <b>Manufacturing Date</b>  </p>	<p>BIN: <b>Refer to below information</b></p>	
<p>(P) Customer Item:  </p>		
<p>(V) Vendor ID:  </p>	<p>(9D) Date Code: <b>Date Code</b>  </p>	
<p>DeptID:  </p>	<p>Made In: <b>Country of Origin</b>  </p>	

**(ii) Avago Baby Label (Only available on bulk packaging)**

 <b>Avago</b> TECHNOLOGIES <b>Lamps Baby Label</b>		RoHS Compliant e3 max temp 250C
(1P) PART #: Part Number 		
(1T) LOT #: Lot Number 		
(9D)MFG DATE: Manufacturing Date 	QUANTITY: Packing Quantity 	
C/O: Country of Origin		
Customer P/N: 	CAT: Intensity Bin 	
Supplier Code: 	BIN: Refer to below information 	
	DATECODE: Date Code 	

**Acronyms and Definition:**

BIN:

(i) Color bin only or VF bin only

(Applicable for part number with color bins but without VF bin OR part number with VF bins and no color bin)

OR

(ii) Color bin incorporated with VF Bin

(Applicable for part number that have both color bin and VF bin)

Example:

(i) Color bin only or VF bin only

BIN: 2 (represent color bin 2 only)

BIN: VB (represent VF bin "VB" only)

(ii) Color bin incorporate with VF Bin

BIN: 2VB

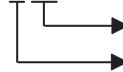

VB: VF bin "VB"

2: Color bin 2 only

**DISCLAIMER:** AVAGO'S PRODUCTS AND SOFTWARE ARE NOT SPECIFICALLY DESIGNED, MANUFACTURED OR AUTHORIZED FOR SALE AS PARTS, COMPONENTS OR ASSEMBLIES FOR THE PLANNING, CONSTRUCTION, MAINTENANCE OR DIRECT OPERATION OF A NUCLEAR FACILITY OR FOR USE IN MEDICAL DEVICES OR APPLICATIONS. CUSTOMER IS SOLELY RESPONSIBLE, AND WAIVES ALL RIGHTS TO MAKE CLAIMS AGAINST AVAGO OR ITS SUPPLIERS, FOR ALL LOSS, DAMAGE, EXPENSE OR LIABILITY IN CONNECTION WITH SUCH USE.

For product information and a complete list of distributors, please go to our website: [www.avagotech.com](http://www.avagotech.com)

Avago, Avago Technologies, and the A logo are trademarks of Avago Technologies in the United States and other countries. Data subject to change. Copyright © 2005-2014 Avago Technologies. All rights reserved. Obsoletes 5989-4364EN AV02-1541EN - July 18, 2014



## X-ON Electronics

Largest Supplier of Electrical and Electronic Components

*Click to view similar products for [Standard LEDs - Through Hole category:](#)*

*Click to view products by [Broadcom manufacturer:](#)*

Other Similar products are found below :

[LTL-10254W](#) [LTL-1214A](#) [LTL-1BEDJ](#) [LTL-2231AT](#) [LTL-3251A](#) [LTL-4262N](#) [LTL-5234](#) [LTL87HTBK](#) [LTL-87HD4B](#) [7383/V7C3-BSTA-L/PR3/MS](#) [HLMP-AG64-X10ZZ](#) [HLMP-EG1A-Z10DV](#) [HLMP-EL3B-WXKDD](#) [HLMP-HB74-UVBDD](#) [HLMP-HG65-VY0DD](#) [HLMP-HM74-34CDD](#) [HLMP-HM75-34CDD](#) [1L0532V23G0TD001](#) [NSPW500CS](#) [C4SMA-BGF-CQ34Q3C2](#) [L53GC13](#) [S4SMS-BJF-CQ42QGF2](#) [S4SMS-GJF-CW12QMF2](#) [LD CQDP-1U3U-W5-1-K](#) [LO566UHR3-70G-A3](#) [SLA560WBD2PT3](#) [LP379PPG1C0G0300001](#) [SLR-322MCT32](#) [SLR-342DUT32](#) [SLR343BC7TT32](#) [SLR343BCTT32](#) [SLX-LX3044GD](#) [SLX-LX3044ID](#) [SLX-LX3044YD](#) [1.90690.3330000](#) [SSL-LX20483ID](#) [SSL-LX3034YD](#) [SSL-LX5093LGT-11](#) [SSL-LX5093PGC](#) [SSL-LX5093SRC/F](#) [SSL-LX5093SYT](#) [SSL-LX509E3SIT](#) [SSL-LX509FT3ID](#) [SSL-LX50FT3GD](#) [SSS-LX4673ID-410B](#) [1L0532Y24I0TD001](#) [264-7SYGD/S530-E2](#) [CP41A-AFS-CL0P0454](#) [HLMP1385](#) [LTL-10224W](#)