

HLMP-HG70/71, HLMP-HL70/71

5-mm Standard Oval Red and Amber LEDs

Description

The Broadcom precision optical performance oval LEDs are specifically designed for full color/video and passenger information signs. The oval-shaped radiation pattern and high-luminous intensity ensure that these devices are excellent for wide field of view outdoor applications where a wide viewing angle and readability in sunlight are essential. The package epoxy contains UV inhibitors to reduce the effects of long term exposure to direct sunlight.

Applications

- Gas Price Signs
- Mono Color Signs – Marquees

Features

- Well defined spatial radiation pattern
- High brightness material
- Available in Red and Amber
 - Red AlInGaP 626 nm
 - Amber AlInGaP 590 nm
- Superior resistance to moisture
- Standoff and non-standoff Package
- Tinted and diffused
- Typical viewing angle 40° × 100°

Figure 1: Package Drawing

A

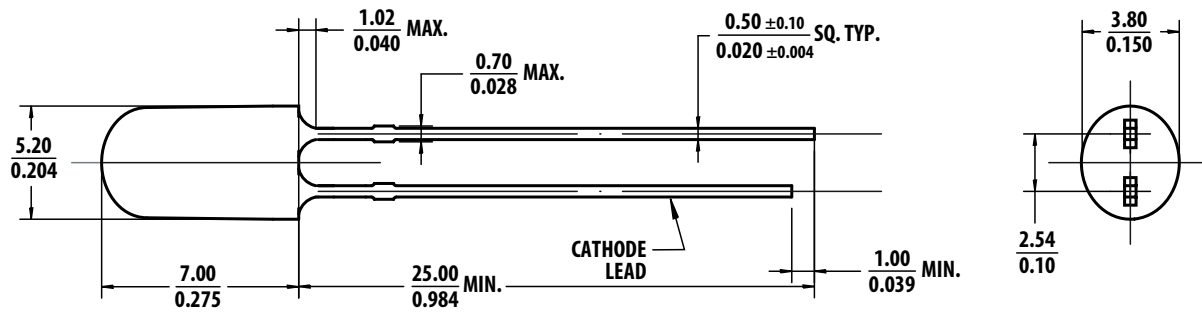

B

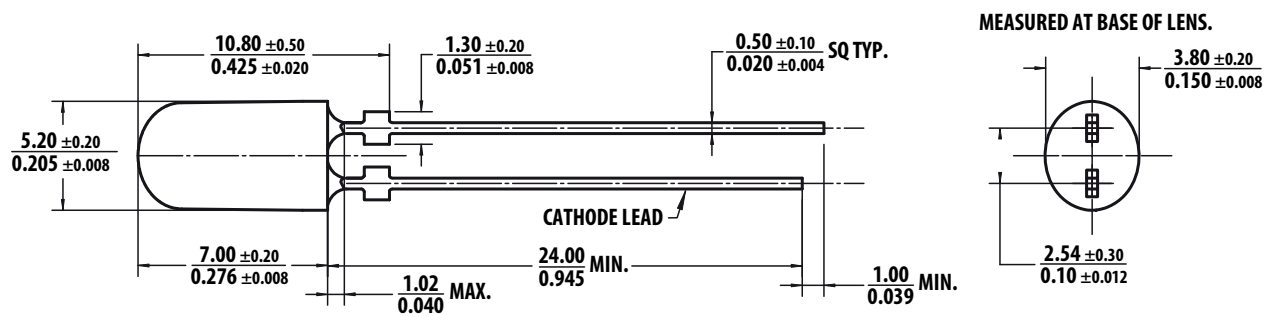

NOTE:

1. All dimensions in millimeters (inches).
2. Tolerance is ± 0.20 mm unless otherwise specified.

Device Selection Guide

Part Number	Color and Dominant Wavelength, λ_d (nm) ^a Typ.	Luminous Intensity, I_V (mcd) ^{b, c, d}		Standoff	Typical Viewing Angle (°) ^e	Package Drawing
		Min.	Max.			
HLMP-HG70-VX0DD	Red 626	1150	1990	No	40 × 100	A
HLMP-HG70-WX0DD	Red 626	1380	1990	No		A
HLMP-HG71-VX0DD	Red 626	1150	1990	Yes		B
HLMP-HG71-WX0DD	Red 626	1380	1990	Yes		B
HLMP-HG71-WY0DD	Red 626	1380	2400	Yes		B
HLMP-HL70-XZ0DD	Amber 590	1660	2900	No		A
HLMP-HL70-XZKDD	Amber 590	1660	2900	No		A
HLMP-HL71-XZ000	Amber 590	1660	2900	Yes		B
HLMP-HL71-XZ0DD	Amber 590	1660	2900	Yes		B
HLMP-HL71-XZKDD	Amber 590	1660	2900	Yes		B

- Dominant wavelength, λ_d , is derived from the CIE Chromaticity Diagram and represents the color of the lamp.
- The luminous intensity is measured on the mechanical axis of the lamp package and it is tested with pulsing condition.
- The optical axis is closely aligned with the package mechanical axis.
- Tolerance for each bin limit is $\pm 15\%$.
- $\theta_{1/2}$ is the off-axis angle where the luminous intensity is half the on-axis intensity.

Absolute Maximum Ratings ($T_J = 25\text{ }^\circ\text{C}$)

Parameter	Red/Amber	Unit
DC Forward Current ^a	50	mA
Peak Forward Current	100 ^b	mA
Power Dissipation	120	mW
LED Junction Temperature	130	°C
Operating Temperature Range	-40 to +100	°C
Storage Temperature Range	-40 to +100	°C

- Derate linearly as shown in Figure 5.
- Duty Factor 30%, frequency 1 kHz.

Electrical/Optical Characteristics ($T_J = 25\text{ }^\circ\text{C}$)

Parameter	Symbol	Min.	Typ.	Max.	Units	Test Conditions
Forward Voltage Red and Amber	V_F	1.8	2.1	2.4	V	$I_F = 20\text{ mA}$
Reverse Voltage ^a Red and Amber	V_R	5	—	—	V	$I_R = 100\text{ }\mu\text{A}$
Dominant Wavelength ^b Red Amber	λ_d	618.0 584.50	626.0 590.0	630.0 594.5	nm	$I_F = 20\text{ mA}$
Peak Wavelength Red Amber	λ_{PEAK}	—	634 594	—	nm	Peak of Wavelength of Spectral Distribution at $I_F = 20\text{ mA}$
Thermal Resistance	$R_{\theta J-PIN}$	—	240	—	$^\circ\text{C/W}$	LED Junction-to-Pin
Luminous Efficacy ^c Red Amber	η_V	—	190 490	—	lm/W	Emitted Luminous Power/Emitted Radiant Power
Thermal Coefficient of λ_d Red Amber		—	0.05 0.09	—	nm/ $^\circ\text{C}$	$I_F = 20\text{ mA}$ $+25\text{ }^\circ\text{C} \leq T_J \leq +100\text{ }^\circ\text{C}$

- a. Indicates product final testing condition. Long term reverse bias is not recommended.
- b. The dominant wavelength is derived from the Chromaticity Diagram and represents the color of the lamp.
- c. The radiant intensity, I_e in watts per steradian, may be found from the equation $I_e = I_V/\eta_V$ where I_V is the luminous intensity in candelas and η_V is the luminous efficacy in lumens/watt.

Part Numbering System

H L M P -

x ₁	x ₂	x ₃	x ₄
----------------	----------------	----------------	----------------

 -

x ₅	x ₆	x ₇	x ₈	x ₉
----------------	----------------	----------------	----------------	----------------

Code	Description	Option	
x ₁	Package type	H	5-mm standard oval 40° × 100°
x ₂	Color	G	Red
		L	Amber
x ₃ x ₄	Lead standoffs	70	Without lead standoffs
		71	With lead standoffs
x ₅	Minimum intensity bin	Refer to Intensity Bin Limits (CAT) Table	
x ₆	Maximum intensity bin		
x ₇	Color bin selection	0	Full range
		K	Color bin 2 and 4
x ₈ x ₉	Packaging option	00	Bulk packaging
		DD	Ammopack

Intensity Bin Limit Table (1.2: 1 Iv Bin Ratio)

Bin	Intensity (mcd) at 20 mA	
	Min.	Max.
V	1150	1380
W	1380	1660
X	1660	1990
Y	1990	2400
Z	2400	2900

Tolerance for each bin limit is ± 15 %.

V_F Bin Table (V at 20 mA)

Bin ID	Min.	Max.
VD	1.8	2.0
VA	2.0	2.2
VB	2.2	2.4

NOTE:

1. Tolerance for each bin limit is ±0.05V.
2. V_F binning only applicable to Red color.

Red Color Range

Min. Dom	Max. Dom	Chromaticity Coordinate			
		x	y	z	w
618.0	630.0	0.6872	0.3126	0.6690	0.2943
		0.6890	0.3149	0.6890	0.2920

Tolerance for each bin limit is ± 0.5 nm.

Amber Color Bin Table

Bin	Min. Dom.	Max. Dom.	Chromaticity Coordinate				
			x	y	z	w	
1	584.5	587.0	x	0.5420	0.5370	0.5530	0.5570
			y	0.4580	0.4550	0.4400	0.4420
2	587.0	589.5	x	0.5570	0.5530	0.5670	0.5720
			y	0.4420	0.4400	0.4250	0.4270
4	589.5	592.0	x	0.5720	0.5670	0.5820	0.5870
			y	0.4270	0.4250	0.4110	0.4130
6	592.0	594.5	x	0.5870	0.5820	0.5950	0.6000
			y	0.4130	0.4110	0.3980	0.3990

Tolerance for each bin limit is ± 0.5 nm.

NOTE: All bin categories are established for classification of products. Products may not be available in all bin categories. Contact your Broadcom representative for further information.

Broadcom Color Bin on CIE 1931 Chromaticity Diagram

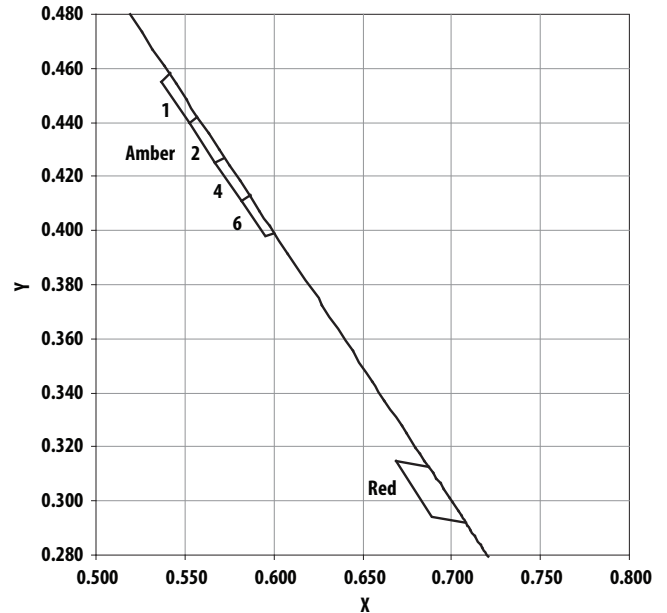

Figure 2: Relative Intensity vs. Wavelength

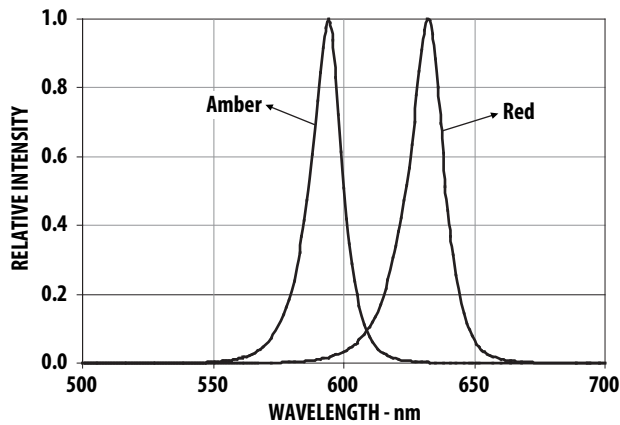

Figure 3: Forward Current vs. Forward Voltage

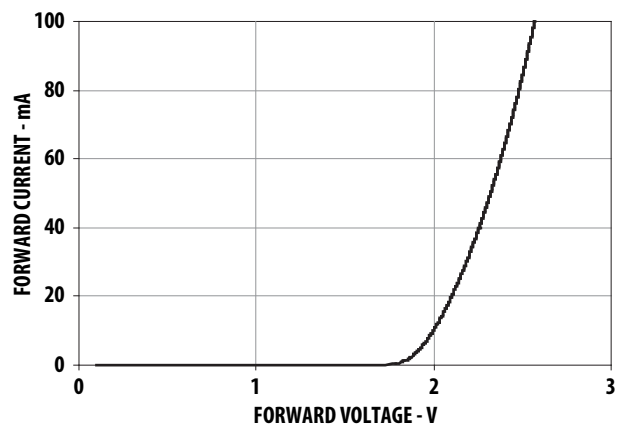

Figure 4: Relative Intensity vs. Forward Current

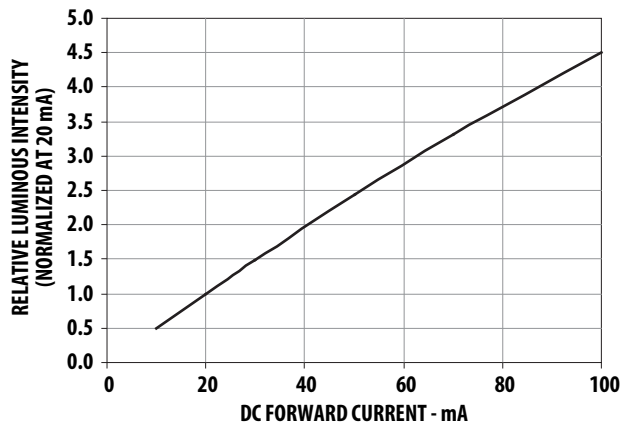

Figure 5: Maximum Forward Current vs. Ambient Temperature

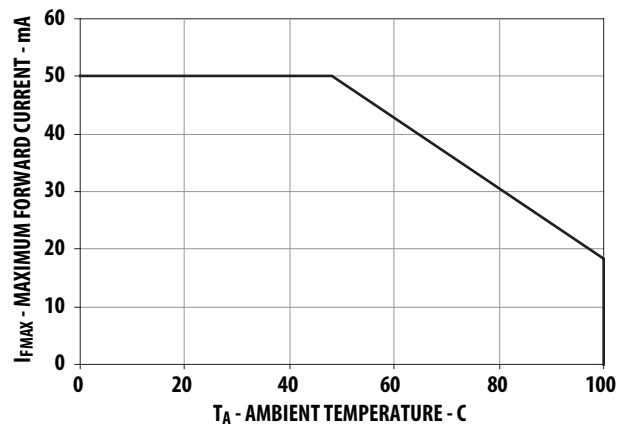

Figure 6: Radiation Pattern for RED – Major Axis

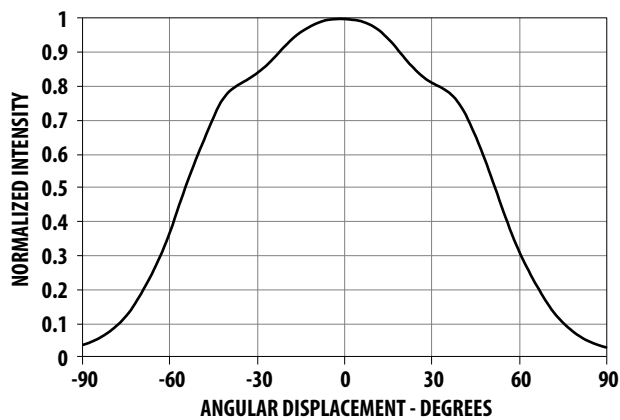

Figure 7: Radiation Pattern for RED – Minor Axis

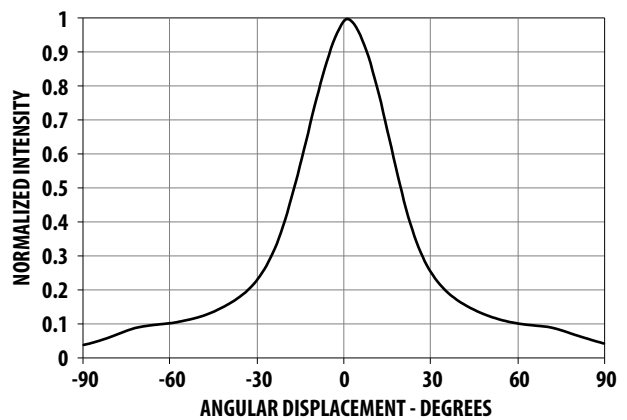

Figure 8: Radiation Pattern for AMBER – Major Axis

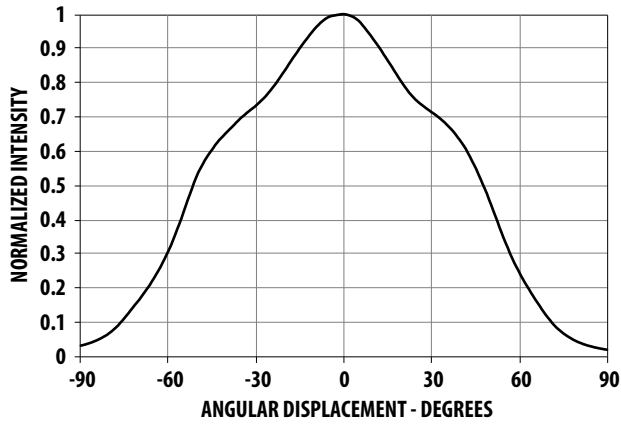

Figure 9: Radiation Pattern for AMBER – Minor Axis

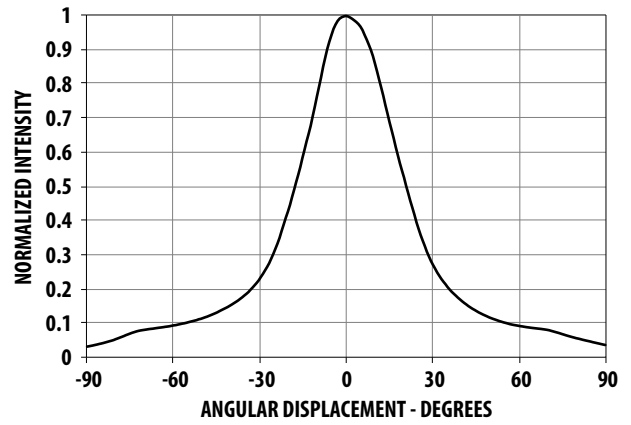

Figure 10: Relative Light Output vs. Junction Temperature

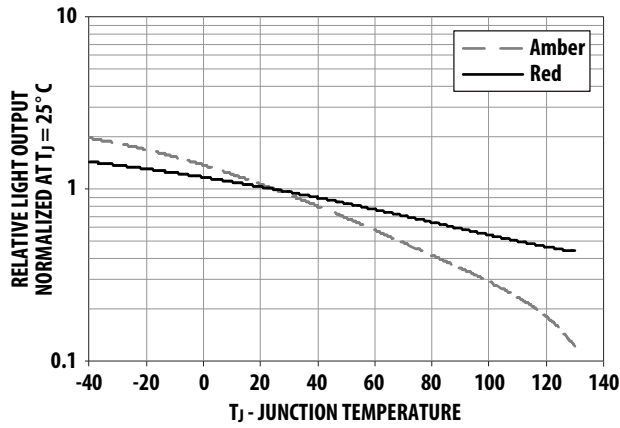

Figure 11: Forward Voltage Shift vs. Junction Temperature

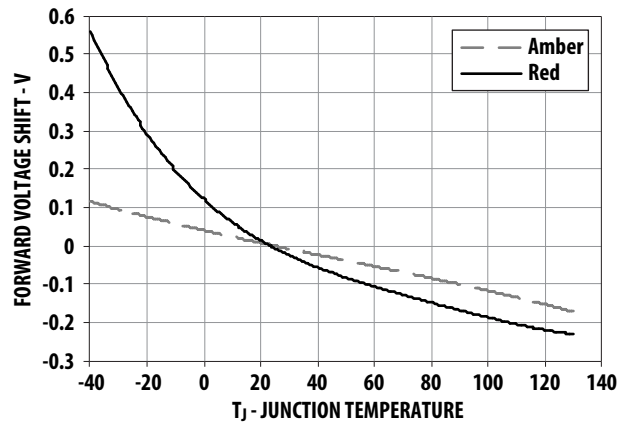
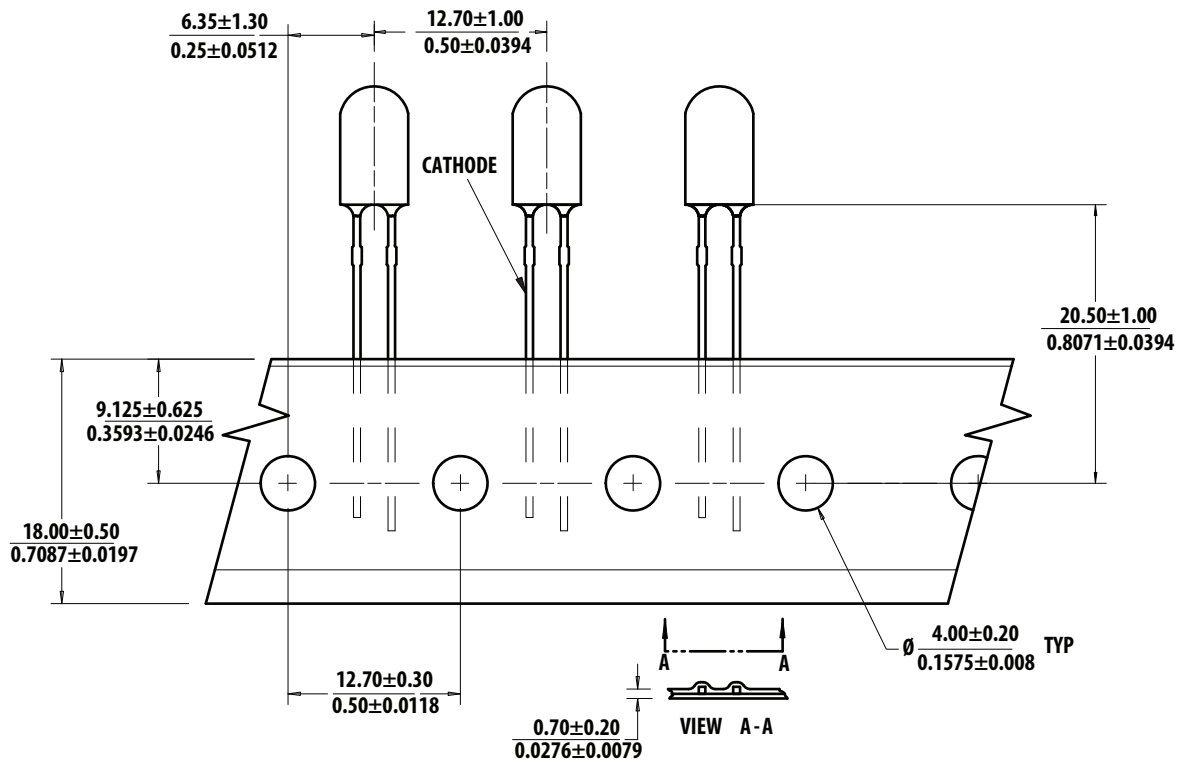
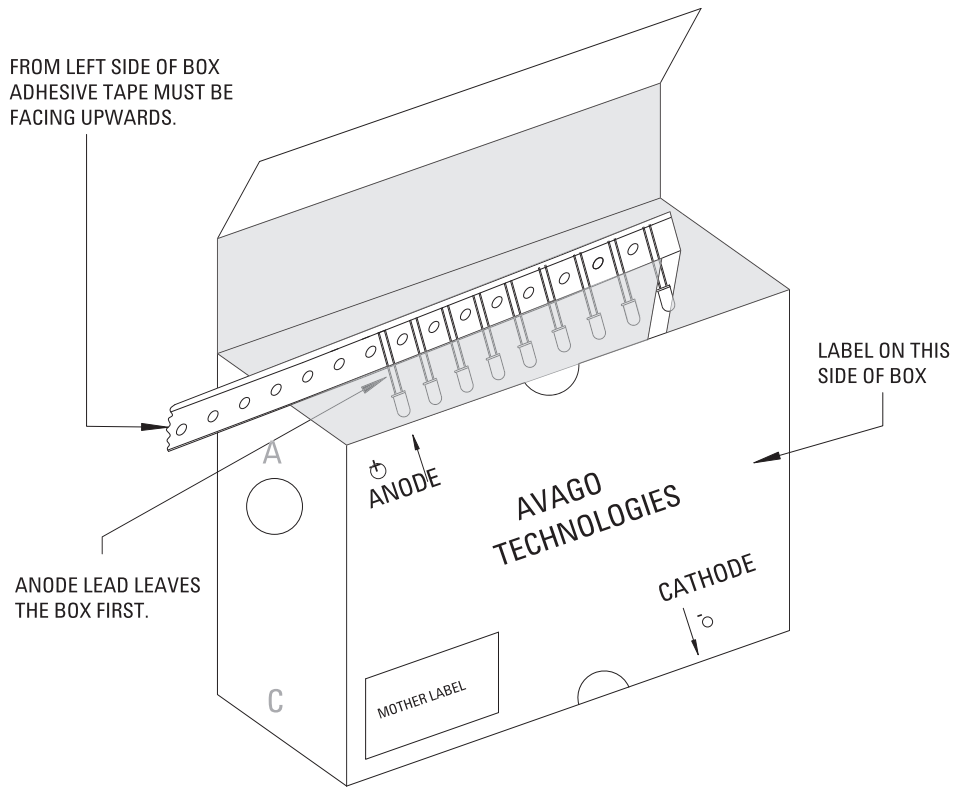

Figure 12: Tape Outline Drawing for Packaging Option DD



NOTE: All dimensions in millimeters (inches).













Figure 13: Packaging Box for Ammo Packs











NOTE: The dimensions for the ammo pack are applicable for the device with standoff and without standoff.

Packaging Label

(i) Avago Mother Label: (Available on packaging box of ammo pack and shipping box)

	
(1P) Item: Part Number 	STANDARD LABEL LS0002 RoHS Compliant e3 max temp 260C
(1T) Lot: Lot Number 	(Q) QTY: Quantity 
LPN: 	CAT: Intensity Bin 
(9D)MFG Date: Manufacturing Date 	BIN: Refer to below information
<hr/>	
(P) Customer Item: 	
(V) Vendor ID: 	(9D) Date Code: Date Code 
<hr/>	
DeptID: 	Made In: Country of Origin 

(ii) Avago Baby Label (Only available on bulk packaging)

	
Lamps Baby Label	
RoHS Compliant e3 max temp 260C	
(1P) PART #: Part Number 	
(1T) LOT #: Lot Number 	
(9D)MFG DATE: Manufacturing Date 	QUANTITY: Packing Quantity 
<hr/>	
C/O: Country of Origin	
Customer P/N: 	CAT: Intensity Bin 
Supplier Code: 	BIN: Refer to below information 
	DATECODE: Date Code 

Acronyms and Definitions

BIN:

- (i) Color bin only or VF bin only
(Applicable for part number with color bins but without VF bin OR part number with VF bins and no color bin)

OR

- (ii) Color bin incorporated with VF bin
(Applicable for part number that have both color bin and VF bin)

Example:

- (i) Color bin only or VF bin only
 - BIN: 2 (represent color bin 2 only)
 - BIN: VB (represent VF bin "VB" only)
- (ii) Color bin incorporate with VF Bin
 - BIN: 2VB, where:
 - 2 is color bin 2 only
 - VB is VF bin "VB"

Precautions

Lead Forming

- The leads of an LED lamp may be preformed or cut to length prior to insertion and soldering on the PC board.
- For better control, use the proper tool to precisely form and cut the leads to the applicable length rather than doing it manually.
- If manual lead cutting is necessary, cut the leads after the soldering process. The solder connection forms a mechanical ground that prevents mechanical stress due to lead cutting from traveling into LED package. Use this procedure for hand solder operation, because the excess lead length also acts as small heat sink.

Soldering and Handling

- Take care during the PCB assembly and soldering process to prevent damage to the LED component.
- The LED component may be effectively hand soldered to PCB. However, it is only recommended under unavoidable circumstances, such as rework. The closest manual soldering distance of the soldering heat source (soldering iron's tip) to the body is 1.59 mm. Soldering the LED using soldering iron tip closer than 1.59 mm might damage the LED.

Figure 14: Manual Soldering Distance

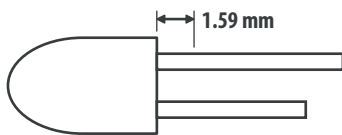

- Apply appropriate ESD precautions on the soldering station and personnel to prevent ESD damage to the LED component, which is ESD sensitive. Refer to Broadcom application note AN 1142 for details. The soldering iron used should have a grounded tip to ensure that electrostatic charge is properly grounded.
- The recommended soldering condition follows.

	Wave Soldering ^{a, b}	Manual Solder Dipping
Pre-heat temperature	105°C maximum	—
Preheat time	60s m maximum	—
Peak temperature	260°C maximum	260°C maximum
Dwell time	5s maximum	5s maximum

- The above conditions refer to measurement with a thermocouple mounted at the bottom of PCB.
- Use only bottom preheaters to reduce thermal stress experienced by the LED.

- Set and maintain wave soldering parameters according to the recommended temperature and dwell time. Perform a daily check on the soldering profile to ensure that it always conforms to the recommended soldering conditions.

NOTE:

- PCBs with different sizes and designs (component density) have different heat mass (heat capacity). This might cause a change in temperature experienced by the board if the same wave soldering setting is used. Therefore, re-calibrate the soldering profile again before loading a new type of PCB.
- Broadcom high-brightness LEDs use a high-efficiency LED die with a single wire bond as shown in Figure 16. Take extra precautions during wave soldering to ensure that the maximum wave temperature does not exceed 260°C and the solder contact time does not exceed 5s. Over-stressing the LED during the soldering process might cause premature failure to the LED due to delamination.

Figure 15: Broadcom LED Configuration

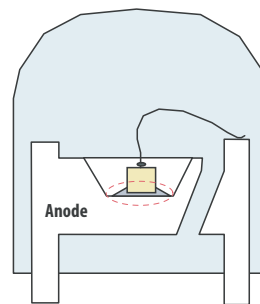

NOTE: Electrical connections between the bottom surface of the LED die and the lead frame are achieved through conductive paste.

- Any alignment fixture that is being applied during wave soldering should be loosely fitted and should not apply weight or force on the LED. Use nonmetal material because it absorbs less heat during the wave soldering process.

NOTE: To further assist the customer in designing the jig accurately that fits the Broadcom product, a 3D model of the product is available upon request.

- At elevated temperatures, the LED is more susceptible to mechanical stress. Therefore, allow the PCB to cool down to room temperature prior to handling, which includes the removal of the alignment fixture or pallet.
- If the PCB board contains both through-hole (TH) LEDs and other surface-mount components, solder the surface-mount components on the top side of the PCB. If the surface mount must be on the bottom side, solder these components using reflow soldering prior to insertion of the TH LED.
- The recommended PC board plated through holes (PTH) size for LED component leads follows.

LED Component Lead Size	Diagonal	Plated Through Hole Diameter
0.45 mm × 0.45 mm (0.018 in. × 0.018 in.)	0.636 mm (0.025 in.)	0.98 mm to 1.08 mm (0.039 in. to 0.043 in.)
0.50 mm × 0.50 mm (0.020 in. × 0.020 in.)	0.707 mm (0.028 in.)	1.05 mm to 1.15 mm (0.041 in. to 0.045 in.)

- Over-sizing the PTH can lead to a twisted LED after clinching. On the other hand, under-sizing the PTH can cause difficulty when inserting the TH LED.

Application Precautions

- The drive current of the LED must not exceed the maximum allowable limit across temperature as stated in the data sheet. Constant current driving is recommended to ensure consistent performance.
- LEDs exhibit slightly different characteristics at different drive currents, which might result in larger performance variation such as intensity, wavelength, and forward voltage). Set the application current as close as possible to the test current to minimize these variations.
- The LED is not intended for reverse bias. Use other appropriate components for such purposes. When driving the LED in matrix form, ensure that the reverse bias voltage does not exceed the allowable limit of the LED.

Figure 16: Example of Wave Soldering Temperature Profile for TH LED

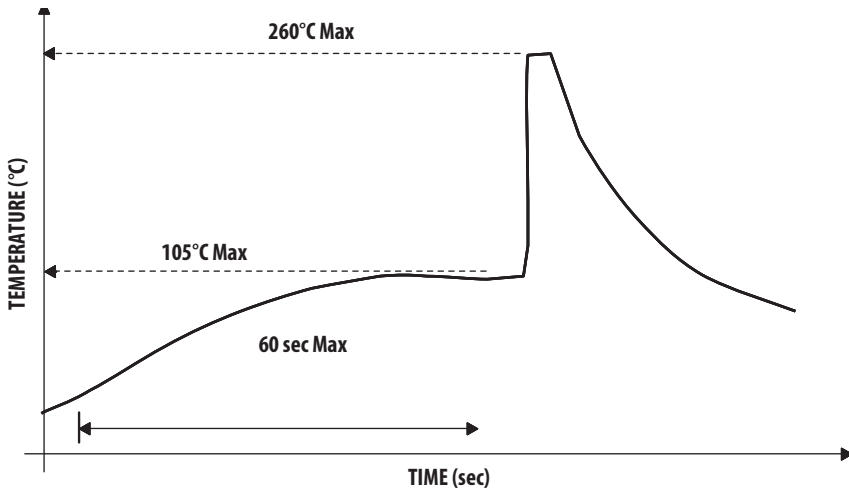

Recommended solder:
 Sn63 (Leaded solder alloy)
 SAC305 (Lead free solder alloy)

Flux: Rosin flux

Solder bath temperature: 255°C ± 5°C
 (maximum peak temperature = 260°C)

Dwell time: 3.0 sec - 5.0 sec
 (maximum = 5sec)

Note: Allow for board to be sufficiently cooled to room temperature before exerting mechanical force.

Disclaimer

Broadcom's products and software are not specifically designed, manufactured, or authorized for sale as parts, components, or assemblies for the planning, construction, maintenance, or direct operation of a nuclear facility or for use in medical devices or applications. The customer is solely responsible, and waives all rights to make claims against Broadcom or its suppliers, for all loss, damage, expense, or liability in connection with such use.

Broadcom, the pulse logo, Connecting everything, Avago Technologies, Avago, and the A logo are among the trademarks of Broadcom and/or its affiliates in the United States, certain other countries, and/or the EU.

Copyright © 2013–2019 Broadcom. All Rights Reserved.

The term "Broadcom" refers to Broadcom Inc. and/or its subsidiaries. For more information, please visit www.broadcom.com.

Broadcom reserves the right to make changes without further notice to any products or data herein to improve reliability, function, or design. Information furnished by Broadcom is believed to be accurate and reliable. However, Broadcom does not assume any liability arising out of the application or use of this information, nor the application or use of any product or circuit described herein, neither does it convey any license under its patent rights nor the rights of others.



X-ON Electronics

Largest Supplier of Electrical and Electronic Components

Click to view similar products for [Standard LEDs - Through Hole category](#):

Click to view products by [Broadcom manufacturer](#):

Other Similar products are found below :

[LTL-10234W](#) [LTL-10254W](#) [LTL-1214A](#) [LTL-2231AT](#) [LTL2H3HRKL13](#) [LTL-3251A](#) [LTL-4262N](#) [LTL-433P](#) [LTL-5234](#) [LTL87HTBK](#)
[LTW-87HD4B](#) [7383/V7C3-BSTA-L/PR3/MS](#) [1254-10SDRDS530-A3](#) [HLMP-3507-D00B1](#) [1L0532V23G0TD001](#) [LO566UHR3-70G-A3](#)
[LP379PPG1C0G0300001](#) [SLR-342MC3F](#) [SLX-LX3044GD](#) [SLX-LX3044ID](#) [SLX-LX3044YD](#) [1.90690.3330000](#) [SSS-LX4673ID-410B](#)
[1L0532Y24I0TD001](#) [264-7SYGD/S530-E2](#) [HLMP1385](#) [LTL-10224W](#) [LTL-1224A](#) [LTL-1BEHJ-012](#) [LTL-2251AT](#) [LTL-403HR](#) [LTL-4222](#)
[LU7-E-B](#) [4380H1](#) [TLHY44K1L2](#) [HLMP-3451-D0000](#) [HLMP-EL08-XYK00](#) [L53SRC/E-Z](#) [L-7679C1ZGC](#) [4302T1-5V](#) [4306D23](#) [4363D1/5](#)
[WP1503SRC/J4](#) [WP153GDT](#) [WP153YDT](#) [WP1543SGC](#) [WP1543SRC/D](#) [WP1543SURC](#) [WP53MGD](#) [WP7113HD](#)