

HLMP-HG70/71, HLMP-HL70/71

5mm Standard Oval Red and Amber LEDs



Data Sheet

Description

These Precision Optical Performance Oval LEDs are specifically designed for full color/video and passenger information signs. The oval shaped radiation pattern and high luminous intensity ensure that these devices are excellent for wide field of view outdoor applications where a wide viewing angle and readability in sunlight are essential. The package epoxy contains UV inhibitors to reduce the effects of long term exposure to direct sunlight.

Applications

- Gas Price Signs
- Mono Color Signs – Marquees

Features

- Well defined spatial radiation pattern
- High brightness material
- Available in Red and Amber
 - Red AlInGaP 626 nm
 - Amber AlInGaP 590 nm
- Superior resistance to moisture
- Standoff and non-standoff Package
- Tinted and diffused
- Typical viewing angle 40° × 100°

Package Dimensions

Package Drawing A

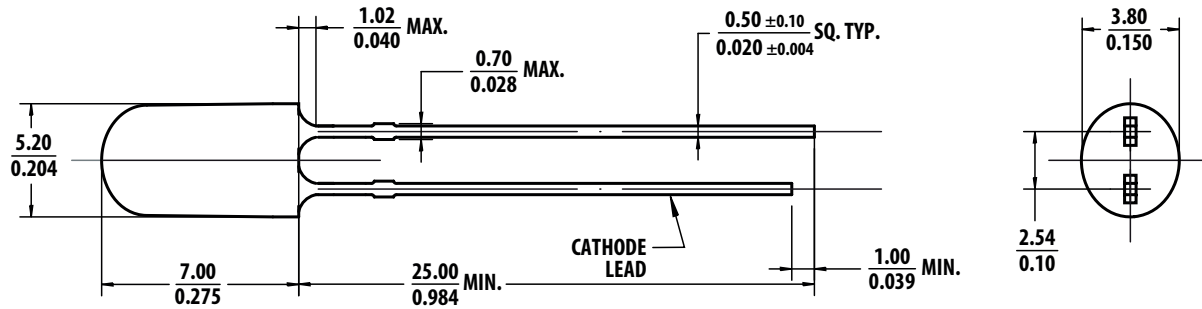

Package Drawing B

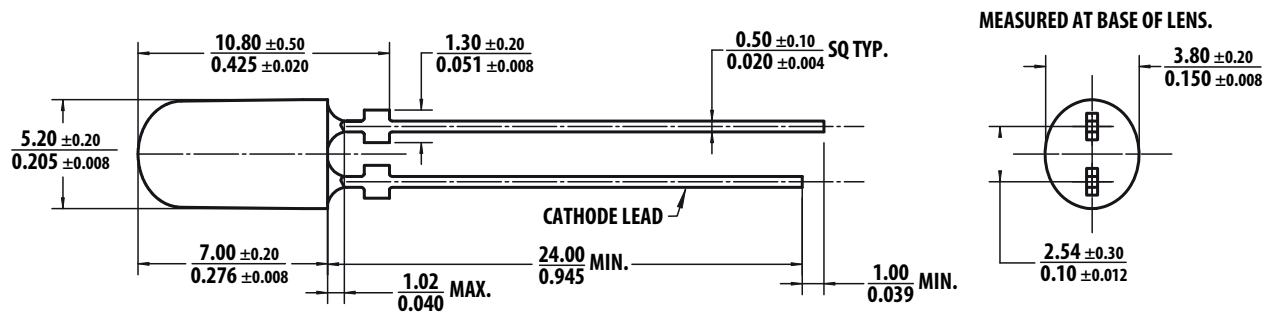

NOTE

1. All dimensions in millimeters (inches).
2. Tolerance is ± 0.20 mm unless otherwise specified.

Device Selection Guide

Part Number	Color and Dominant Wavelength λ_d (nm) Typ ^a	Luminous Intensity I_v (mcd) at 20 mA ^{b,c,d}		Standoff	Typical Viewing Angle (°) ^e	Package Drawing
		Min	Max			
HLMP-HG70-VX0DD	Red 626	1150	1990	No	40 × 100	A
HLMP-HL70-XZ0DD	Amber 590	1660	2900	No		A
HLMP-HL71-XZ0DD	Amber 590	1660	2900	Yes		B

- Dominant wavelength, λ_d , is derived from the CIE Chromaticity Diagram and represents the color of the lamp.
- The luminous intensity is measured on the mechanical axis of the lamp package and it is tested with pulsing condition.
- The optical axis is closely aligned with the package mechanical axis.
- Tolerance for each bin limit is $\pm 15\%$.
- $\theta_{1/2}$ is the off-axis angle where the luminous intensity is half the on-axis intensity.

Part Numbering System

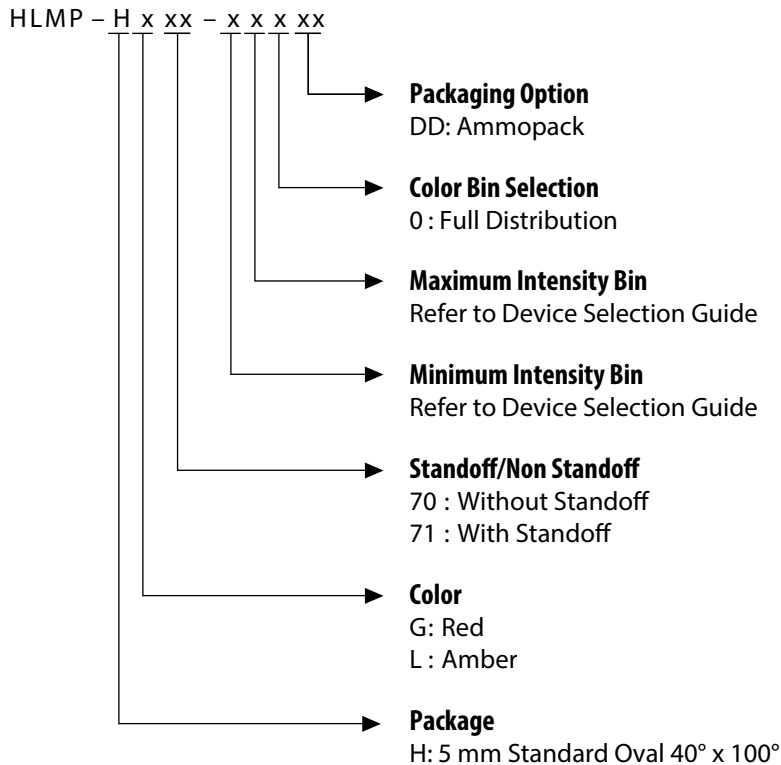

Absolute Maximum Ratings (T_J = 25 °C)

Parameter	Red/Amber	Unit
DC Forward Current ^a	50	mA
Peak Forward Current	100 ^b	mA
Power Dissipation	120	mW
LED Junction Temperature	130	°C
Operating Temperature Range	-40 to +100	°C
Storage Temperature Range	-40 to +100	°C

- a. Derate linearly as shown in Figure 4.
b. Duty Factor 30%, frequency 1 KHz.

Electrical/Optical Characteristics (T_J = 25 °C)

Parameter	Symbol	Min.	Typ.	Max.	Units	Test Conditions
Forward Voltage Red and Amber	V _F	1.8	2.1	2.4	V	I _F = 20 mA
Reverse Voltage ^a Red and Amber	V _R	5			V	I _R = 100 μA
Dominant Wavelength ^b Red Amber	λ _d	618.0 584.50	626.0 590.0	630.0 594.5	nm	I _F = 20 mA
Peak Wavelength Red Amber	λ _{PEAK}		634 594		nm	Peak of Wavelength of Spectral Distribution at I _F = 20 mA
Thermal Resistance	Rθ _{J-PIN}		240		°C/W	LED Junction-to-Pin
Luminous Efficacy ^c Red Amber	η _V		190 490		lm/W	Emitted Luminous Power/Emitted Radiant Power
Thermal Coefficient of λ _d Red Amber			0.05 0.09		nm/°C	I _F = 20 mA +25 °C ≤ T _J ≤ +100 °C

- a. Indicates product final testing condition. Long term reverse bias is not recommended.
b. The dominant wavelength is derived from the Chromaticity Diagram and represents the color of the lamp.
c. The radiant intensity, I_e in watts per steradian, may be found from the equation I_e = I_V/η_V where I_V is the luminous intensity in candelas and η_V is the luminous efficacy in lumens/watt.

Figure 1 Relative Intensity vs. Wavelength

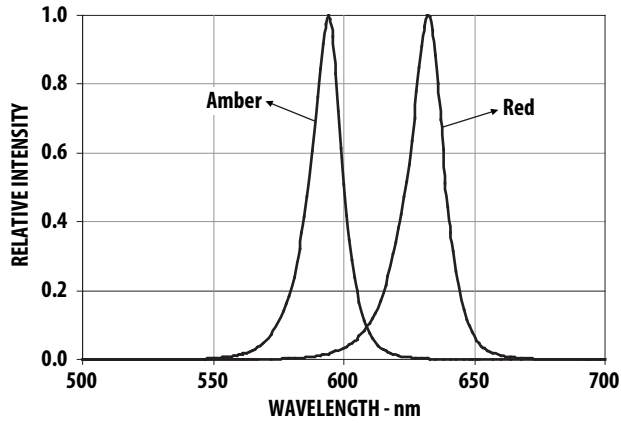

Figure 2 Forward Current vs. Forward Voltage

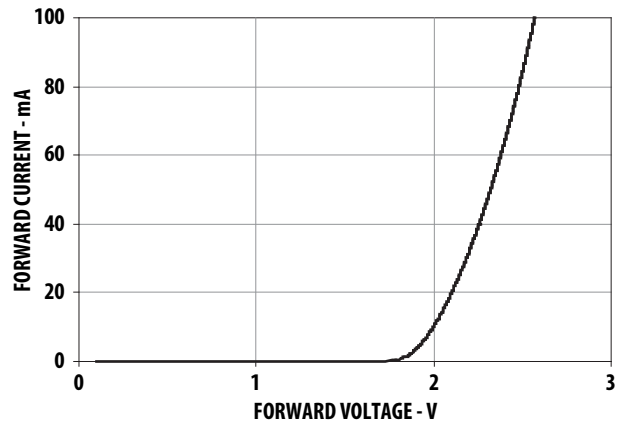

Figure 3 Relative Intensity vs. Forward Current

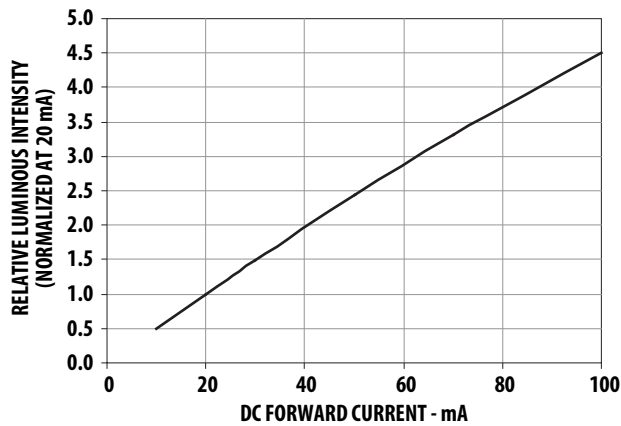

Figure 4 Maximum Forward Current vs. Ambient Temperature

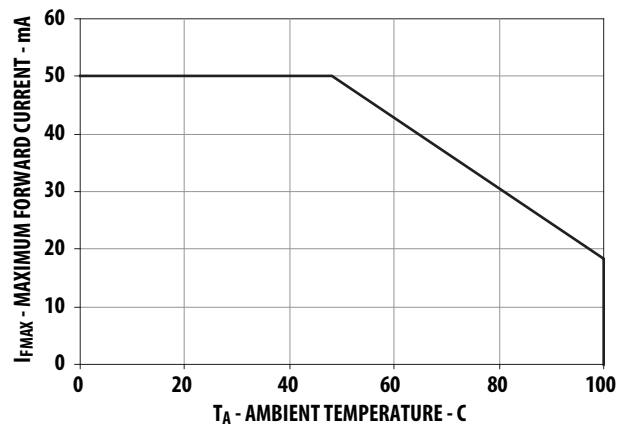

Figure 5 Radiation Pattern for RED – Major Axis

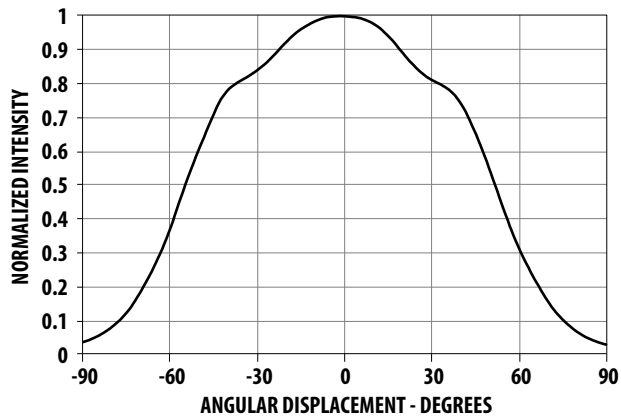

Figure 6 Radiation Pattern for RED – Minor Axis

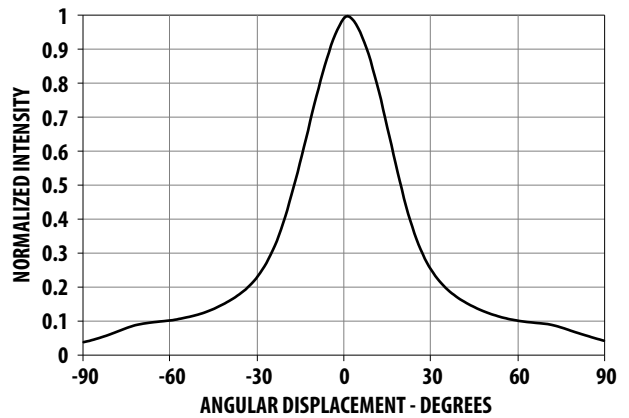

Figure 7 Radiation Pattern for AMBER – Major Axis

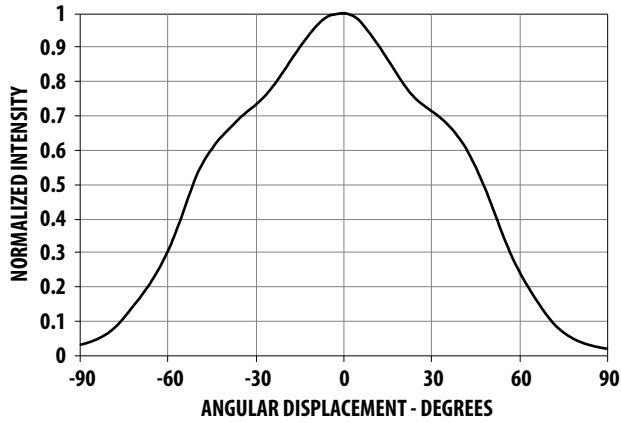

Figure 8 Radiation Pattern for AMBER – Minor Axis

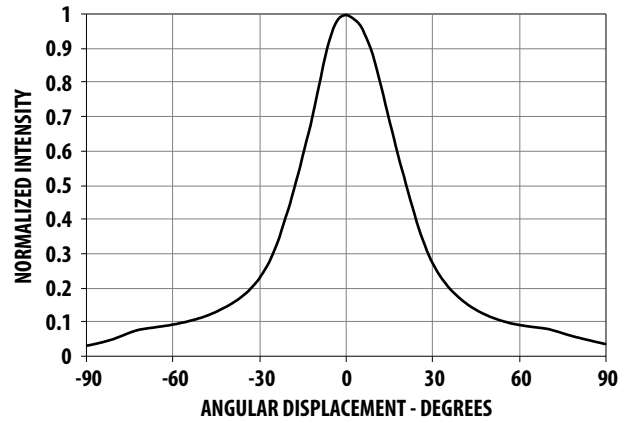

Figure 9 Relative Light Output vs. Junction Temperature

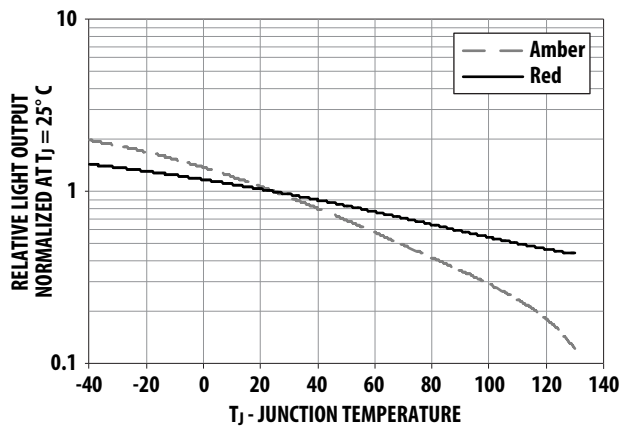
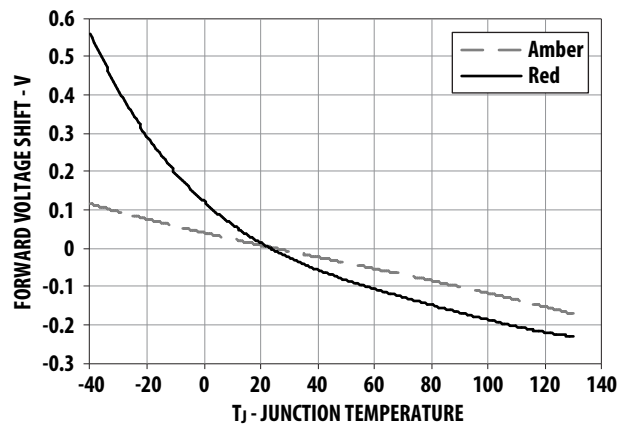

Figure 10 Forward Voltage Shift vs. Junction Temperature



Intensity Bin Limit Table (1.2: 1 Iv Bin Ratio)

Bin	Intensity (mcd) at 20 mA	
	Min	Max
V	1150	1380
W	1380	1660
X	1660	1990
Y	1990	2400
Z	2400	2900

Tolerance for each bin limit is $\pm 15\%$.

V_F Bin Table (V at 20mA)

Bin ID	Min	Max
VD	1.8	2.0
VA	2.0	2.2
VB	2.2	2.4

NOTE

1. Tolerance for each bin limit is $\pm 0.05V$.
2. V_F binning only applicable to Red color.

Red Color Range

Min Dom	Max Dom	Chromaticity Coordinate				
		x	y	z	w	
618.0	630.0	x	0.6872	0.6690	0.6890	0.7080
		y	0.3126	0.3149	0.2943	0.2920

Tolerance for each bin limit is ± 0.5 nm.

Amber Color Bin Table

Bin	Min Dom	Max Dom	Chromaticity Coordinate				
1	584.5	587.0	x	0.5420	0.5370	0.5530	0.5570
			y	0.4580	0.4550	0.4400	0.4420
2	587.0	589.5	x	0.5570	0.5530	0.5670	0.5720
			y	0.4420	0.4400	0.4250	0.4270
4	589.5	592.0	x	0.5720	0.5670	0.5820	0.5870
			y	0.4270	0.4250	0.4110	0.4130
6	592.0	594.5	x	0.5870	0.5820	0.5950	0.6000
			y	0.4130	0.4110	0.3980	0.3990

Tolerance for each bin limit is ± 0.5 nm.

NOTE All bin categories are established for classification of products. Products may not be available in all bin categories. Please contact your Avago representative for further information.

Avago Color Bin on CIE 1931 Chromaticity Diagram

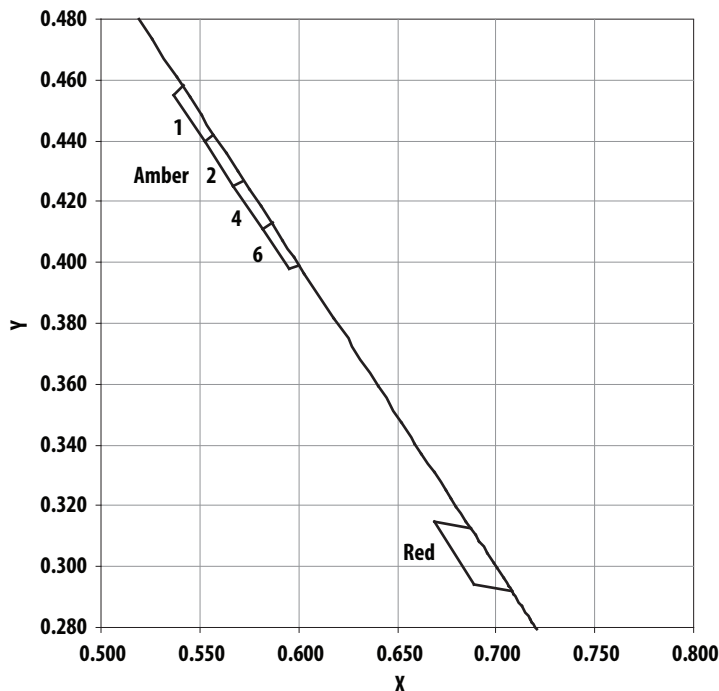

soldering iron tip closer than 1.59 mm might damage the LED.

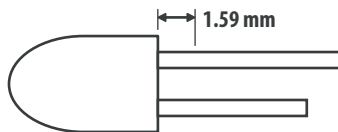

- ESD precaution must be properly applied on the soldering station and personnel to prevent ESD damage to the LED component that is ESD sensitive. Refer to Avago application note AN 1142 for details. The soldering iron used should have a grounded tip to ensure that electrostatic charge is properly grounded.
- Recommended soldering condition follows.

	Wave Soldering ^{a, b}	Manual Solder Dipping
Pre-heat temperature	105 °C Max.	—
Preheat time	60 s Max	—
Peak temperature	260 °C Max.	260 °C Max.
Dwell time	5 s Max.	5 s Max

- The above conditions refer to measurement with a thermocouple mounted at the bottom of PCB.
- It is recommended to use only bottom preheaters to reduce thermal stress experienced by the LED.

- Wave soldering parameters must be set and maintained according to the recommended temperature and dwell time. The customer is advised to perform a daily check on the soldering profile to ensure that it always conforms to the recommended soldering conditions.

NOTE

1. PCBs with different size and design (component density) will have different heat mass (heat capacity). This might cause a change in temperature experienced by the board if the same wave soldering setting is used. So, it is recommended to re-calibrate the soldering profile again before loading a new type of PCB.
2. Avago Technologies' high brightness LEDs use a high efficiency LED die with single wire bond as shown on the next page. The customer is advised to take extra precautions during wave soldering to ensure that the maximum wave temperature does not exceed 260 °C and the solder contact time does not exceed 5 s. Over-stressing the LED during soldering process might cause premature failure to the LED due to delamination.

Precautions

Lead Forming

- The leads of an LED lamp may be preformed or cut to length prior to insertion and soldering on the PC board.
- For better control, it is recommended to use the proper tool to precisely form and cut the leads to applicable length rather than doing it manually.
- If manual lead cutting is necessary, cut the leads after the soldering process. The solder connection forms a mechanical ground that prevents mechanical stress due to lead cutting from traveling into LED package. This is highly recommended for hand solder operation, as the excess lead length also acts as small heat sink.

Soldering and Handling

- Care must be taken during PCB assembly and soldering process to prevent damage to the LED component.
- The LED component may be effectively hand soldered to PCB. However, it is only recommended under unavoidable circumstances, such as rework. The closest manual soldering distance of the soldering heat source (soldering iron's tip) to the body is 1.59 mm. Soldering the LED using

Avago Technologies LED Configuration

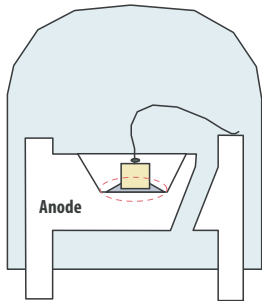

NOTE Electrical connection between the bottom surface of the LED die and the lead frame is achieved through conductive paste.

- Any alignment fixture that is being applied during wave soldering should be loosely fitted and should not apply weight or force on the LED. Non-metal material is recommended because it will absorb less heat during the wave soldering process.

NOTE To further assist the customer in designing he jig accurately that fits the Avago Technologies' product, a 3D model of the product is available upon request.

- At elevated temperatures, the LED is more susceptible to mechanical stress. Therefore, the PCB must allowed to cool down to room temperature prior to handling, which includes removal of the alignment fixture or pallet.
- If the PCB board contains both through hole (TH) LEDs and other surface mount components, it is recommended that surface mount components be soldered on the top side of the PCB. If surface mount must be on the bottom side, these components should be soldered using reflow soldering prior to insertion of the TH LED.

- The recommended PC board plated through holes (PTH) size for LED component leads follows.

LED component lead size	Diagonal	Plated through hole diameter
0.45 mm × 0.45 mm (0.018 in. × 0.018 in.)	0.636 mm (0.025 in.)	0.98 mm to 1.08 mm (0.039 in. to 0.043 in.)
0.50 mm × 0.50 mm (0.020 in. × 0.020 in.)	0.707 mm (0.028 in.)	1.05 mm to 1.15 mm (0.041 in. to 0.045 in.)

- Over-sizing the PTH can lead to a twisted LED after clinching. On the other hand, under-sizing the PTH can cause difficulty when inserting the TH LED.

Application Precautions

- The drive current of the LED must not exceed the maximum allowable limit across temperature as stated in the data sheet. Constant current driving is recommended to ensure consistent performance.
- LEDs exhibit slightly different characteristics at different drive currents that might result in larger performance variation (i.e., intensity, wavelength, and forward voltage). The user is recommended to set the application current as close as possible to the test current to minimize these variations.
- The LED is not intended for reverse bias. Use other appropriate components for such purposes. When driving the LED in matrix form, it is crucial to ensure that the reverse bias voltage does not exceed the allowable limit of the LED.

Example of Wave Soldering Temperature Profile for TH LED

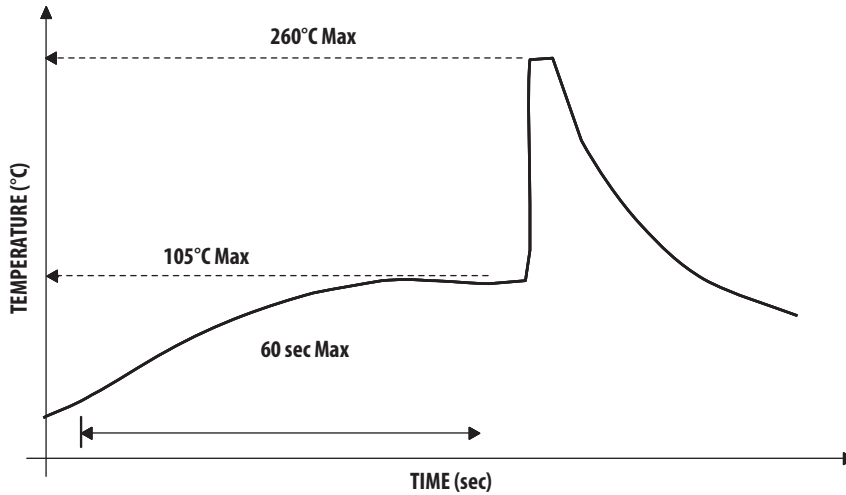

Recommended solder:
Sn63 (Leaded solder alloy)
SAC305 (Lead free solder alloy)

Flux: Rosin flux

Solder bath temperature: 255°C ± 5°C
(maximum peak temperature = 260°C)

Dwell time: 3.0 sec - 5.0 sec
(maximum = 5sec)

Note: Allow for board to be sufficiently cooled to room temperature before exerting mechanical force.

Ammo Packs Drawing

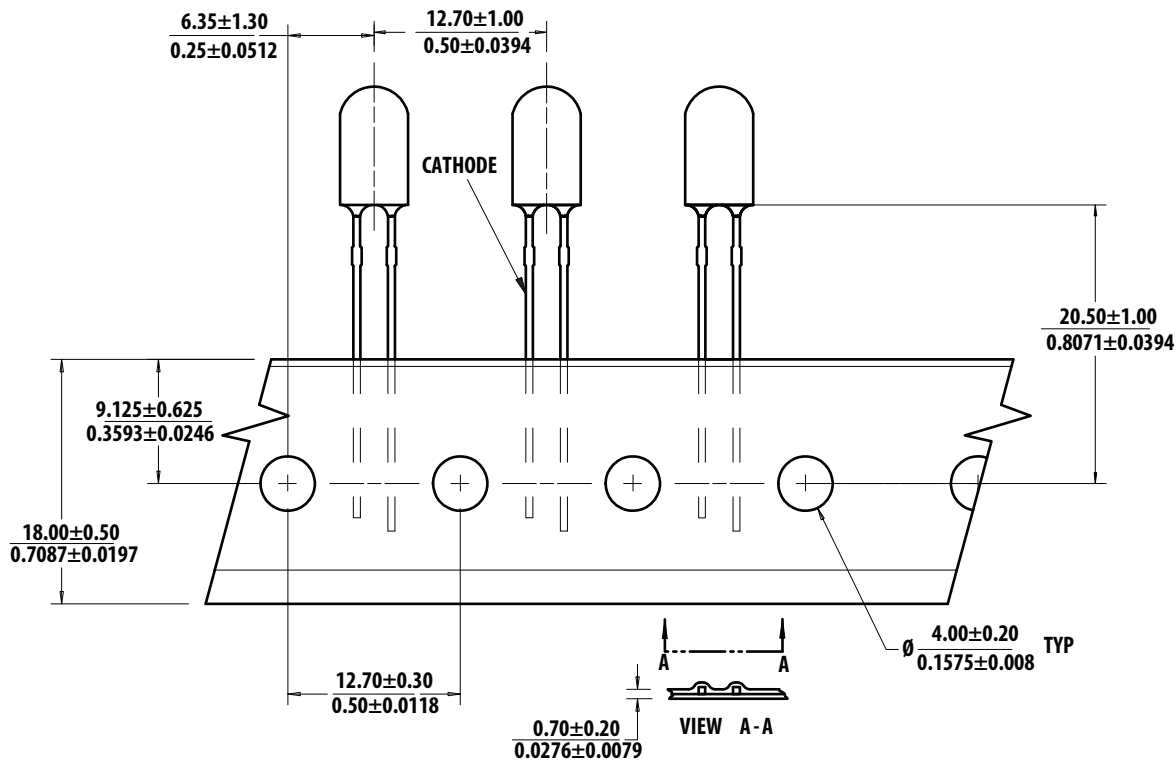

NOTE All dimensions in millimeters (inches).



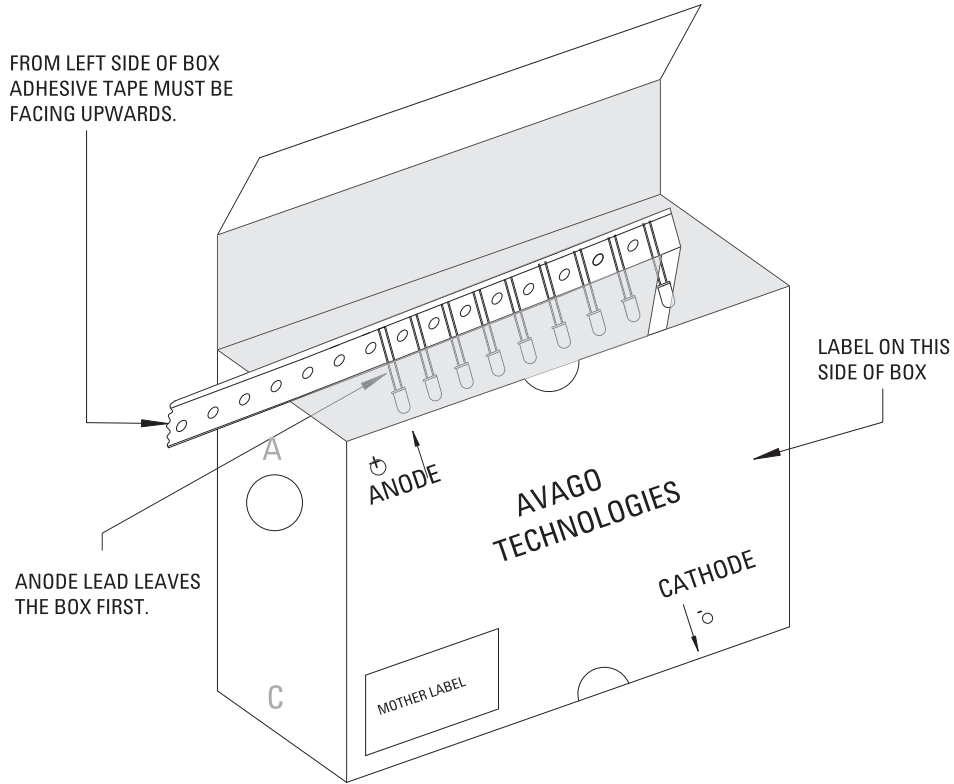







Packaging Box for Ammo Packs













NOTE The dimensions for the ammo pack are applicable for the device with standoff and without standoff.

Packaging Label

(i) Avago Mother Label: (Available on packaging box of ammo pack and shipping box)

	
(1P) Item: Part Number 	STANDARD LABEL LS0002 RoHS Compliant e3 max temp 260C
(1T) Lot: Lot Number 	(Q) QTY: Quantity 
LPN: 	CAT: Intensity Bin 
(9D)MFG Date: Manufacturing Date 	BIN: Refer to below information
<hr/>	
(P) Customer Item: 	
(V) Vendor ID: 	(9D) Date Code: Date Code 
<hr/>	
DeptID: 	Made In: Country of Origin 

(ii) Avago Baby Label (Only available on bulk packaging)

	
Lamps Baby Label	
RoHS Compliant e3 max temp 260C	
(1P) PART #: Part Number 	
(1T) LOT #: Lot Number 	
(9D)MFG DATE: Manufacturing Date 	QUANTITY: Packing Quantity 
C/O: Country of Origin	
<hr/>	
Customer P/N: 	CAT: Intensity Bin 
Supplier Code: 	BIN: Refer to below information 
	DATECODE: Date Code 

Acronyms and Definition

BIN:

- (i) Color bin only or VF bin only
(Applicable for part number with color bins but without VF bin OR part number with VF bins and no color bin)

OR

- (ii) Color bin incorporated with VF Bin
(Applicable for part number that have both color bin and VF bin)

Example:

- (i) Color bin only or VF bin only
 - BIN: 2 (represent color bin 2 only)
 - BIN: VB (represent VF bin "VB" only)
- (ii) Color bin incorporate with VF Bin
 - BIN: 2VB, where:
 - 2 is color bin 2 only
 - VB is VF bin "VB"

DISCLAIMER: Avago's products and software are not specifically designed, manufactured or authorized for sale as parts, components or assemblies for the planning, construction, maintenance or direct operation of a nuclear facility or for use in medical devices or applications. Customer is solely responsible, and waives all rights to make claims against Avago or its suppliers, for all loss, damage, expense or liability in connection with such use.

For product information and a complete list of distributors, please go to our web site:

www.avagotech.com

Avago Technologies and the A logo are trademarks of Avago Technologies in the United States and other countries. All other brand and product names may be trademarks of their respective companies.

Data subject to change. Copyright © 2013–2016 Avago Technologies. All Rights Reserved.

AV02-3174EN – June 3, 2016

AVAGO
TECHNOLOGIES



Lead (Pb) Free
RoHS 6 fully
compliant

X-ON Electronics

Largest Supplier of Electrical and Electronic Components

Click to view similar products for [Standard LEDs - Through Hole category:](#)

Click to view products by [Broadcom manufacturer:](#)

Other Similar products are found below :

[LTL-10254W](#) [LTL-1214A](#) [LTL-3251A](#) [LTL-4262N](#) [LTL-433P](#) [LTL-5234](#) [LTL87HTBK](#) [LTL-87HD4B](#) [HLMP-EL30-PS0DD](#)
[1L0532V23G0TD001](#) [NSPW500CS](#) [NTE30036](#) [NTE30044](#) [NTE30059](#) [NTE3020](#) [LD CQDP-1U3U-W5-1-K](#) [LO566UHR3-70G-A3](#)
[LP379PPG1C0G0300001](#) [SLX-LX3044GD](#) [SLX-LX3044ID](#) [SLX-LX3044YD](#) [1.90690.3330000](#) [SSS-LX4673ID-410B](#) [1L0532Y24I0TD001](#)
[264-7SYGD/S530-E2](#) [HLMP1385](#) [LTL-10224W](#) [LTL-1224A](#) [LTL-1234A](#) [LTL-2251AT](#) [LTL-307YE-012](#) [LTL-403HR](#) [LTL-4222](#) [LU7-E-](#)
[B](#) [4380H1](#) [TLHY44K1L2](#) [HLMP-3962-F0002](#) [HLMP-GG15-R0000](#) [323-2SURD/S530-A3](#) [L53SRC/E-Z](#) [L-7679C1ZGC](#) [4302T1-5V](#)
[4306D23](#) [4363D1/5](#) [WP1503SRC/J4](#) [WP153GDT](#) [WP153YDT](#) [WP1543SGC](#) [WP1543SURC](#) [WP53MGD](#)