

Data Sheet

Description

These InGaN lamps are designed in industry standard package with clear and non-diffused optics. These lamps are ideal for use as indicator and for general purpose lighting.

Package Dimensions

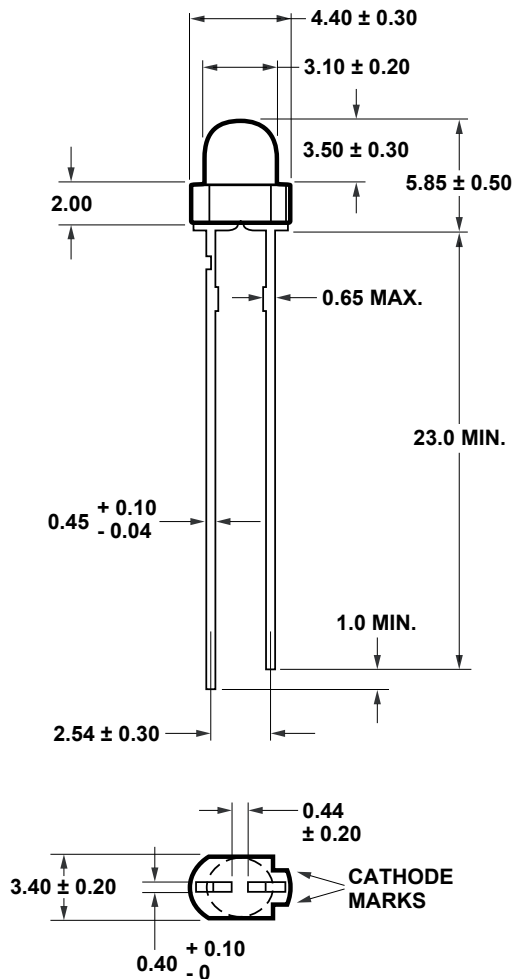

NOTES:

1. ALL DIMENSIONS ARE IN MILLIMETERS (INCHES).
2. EPOXY MENISCUS MAY EXTEND ABOUT 1 mm (0.040") DOWN THE LEADS.

Features

- General purpose LED
- Reliable and rugged
- Binned for color and intensity
- Bright InGaN dice

Applications

- Status indicator
- Small message panel
- Running and decorative lights for commercial use
- Back lighting
- Consumer audio

CAUTION: DEVICES ARE CLASS 1 ESD SENSITIVE. PLEASE OBSERVE APPROPRIATE PRECAUTIONS DURING HANDLING AND PROCESSING. REFER TO APPLICATION NOTE AN-1142 FOR ADDITIONAL DETAILS

Selection Guide

Part Number	Color and Dominant Wavelength λ_d (nm) Typ.	Luminous Intensity, I_v (mcd) at 20 mA		Viewing Angle, $2\theta_{1/2}$ (degree)	Tinting Type
		Min.	Typ.		
HLMP-NS31-J00xx	Blue 470	240	600	30	Un-tinted; non-diffused
HLMP-NM31-R00xx	Green 529	1500	2800		

Notes:

1. The luminous intensity is measured on the mechanical axis of the lamp package
2. The tolerance for intensity limit is $\pm 15\%$
3. The optical axis is closely aligned with the package mechanical axis
4. The dominant wavelength, λ_d , is derived from the Chromaticity Diagram and represents the color of the lamp.

Absolute Maximum Ratings, $T_A = 25^\circ\text{C}$

Parameter	Blue /Green	Unit
DC Forward Current ^[1]	30	mA
Peak Forward Current	100	mA
Reverse Voltage ($I_R = 10\mu\text{A}$)	5	V
LED Junction Temperature	115	$^\circ\text{C}$
Operating Temperature Range	-40 to +85	$^\circ\text{C}$
Storage Temperature Range	-40 to +85	$^\circ\text{C}$

Notes:

1. Derate linearly as shown in Figure 5

Electrical/Optical Characteristics

Parameter	Symbol		Min.	Typ.	Max.	Units	Test Condition
Forward Voltage	V_F		3.0	3.3	4.0	V	$I_F = 20\text{ mA}$
Reverse Voltage	V_R		5			V	$I_R = 10\ \mu\text{A}$
Dominant wavelength	λ_d	NS31	460	470	480	nm	$I_F = 20\text{ mA}$
		NM31	520	529	540		
Peak wavelength	λ_{peak}	NS31		464		nm	Peak of wavelength of spectral distribution at $I_F = 20\text{ mA}$
		NM31		519			
Thermal Resistance	$R\theta_{J-PIN}$			290		$^\circ\text{C}/\text{W}$	

Notes:

1. The dominant wavelength λ_d is derived from the Chromaticity Diagram and represents the color of the lamp.
2. Tolerance for each color bin limit is $\pm 0.5\text{ nm}$

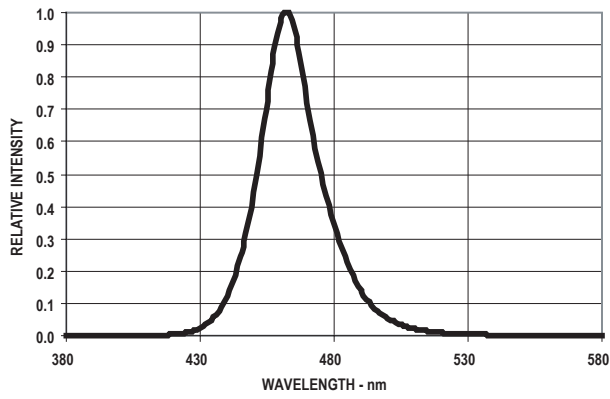

Figure 1. Relative Intensity vs wavelength for HLMP-NS31

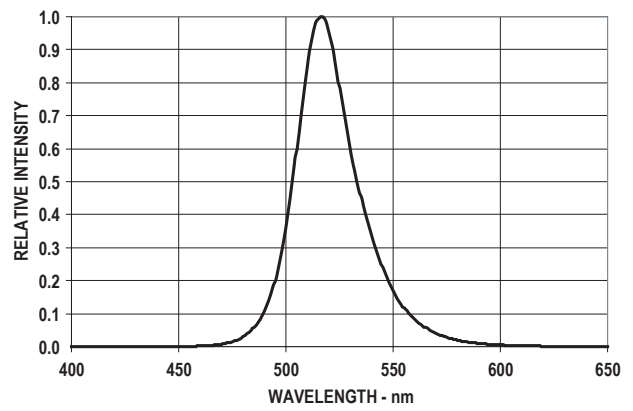

Figure 2. Relative Intensity vs wavelength for HLMP-NM31

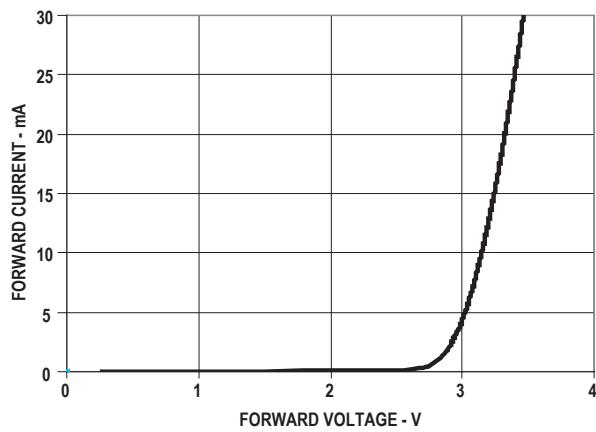

Figure 3. Forward Current vs Forward Voltage

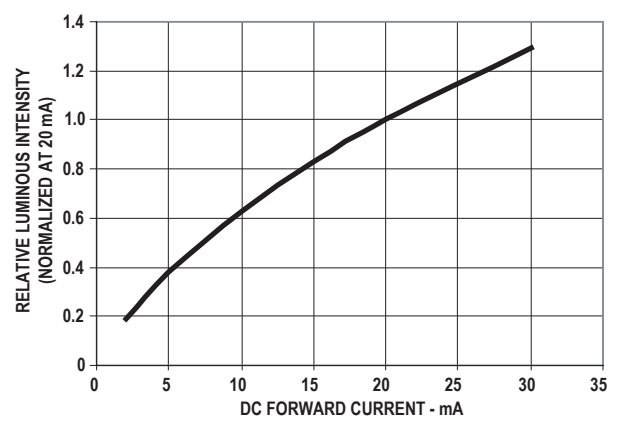

Figure 4. Relative Intensity vs Forward Current

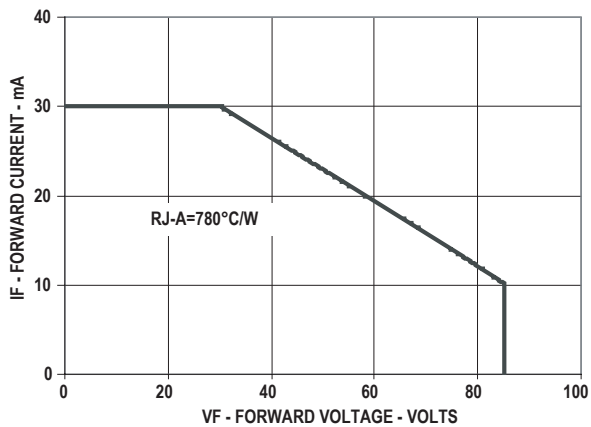

Figure 5. Maximum Forward current vs Ambient temperature based on $T_J=110^{\circ}\text{C}$

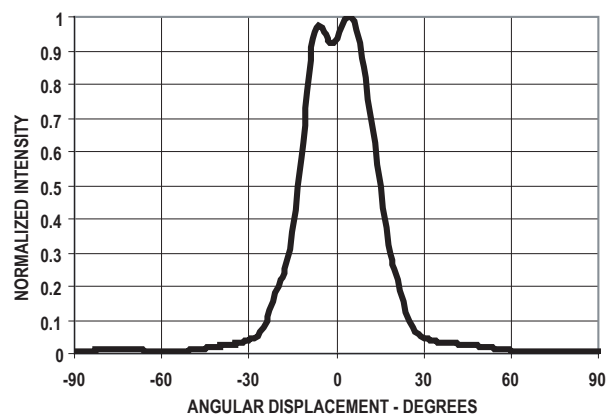

Figure 6. Radiation pattern

Intensity Bin Limit Table

Bin	Intensity (mcd) at 20 mA	
	Min	Max
J	240	310
K	310	400
L	400	520
M	520	680
N	680	880
P	880	1150
Q	1150	1500
R	1500	1900
S	1900	2500
T	2500	3200
U	3200	4200

Tolerance for each bin limit is $\pm 15\%$

Blue Color Bin Limit Table

Bin	Intensity (mcd) at 20 mA	
	Min	Max
1	460	464
2	464	468
3	468	472
4	472	476
5	476	480

Tolerance for each bin limit is $\pm 0.5\text{nm}$

Green Color Bin Limit Table

Bin	Dominant Wavelength (nm) at 20 mA	
	Min	Max
1	520	524
2	524	528
3	528	532
4	532	536
5	536	540

Tolerance for each bin limit is $\pm 0.5\text{nm}$

Precautions:

Lead Forming:

- The leads of an LED lamp may be preformed or cut to length prior to insertion and soldering into PC board.
- If lead forming is required before soldering, care must be taken to avoid any excessive mechanical stress induced to LED package. Otherwise, cut the leads of LED to length after soldering process at room temperature. The solder joint formed will absorb the mechanical stress of the lead cutting from traveling to the LED chip die attached and wirebond.
- It is recommended that tooling made to precisely form and cut the leads to length rather than rely upon hand operation.

Soldering Condition:

- Care must be taken during PCB assembly and soldering process to prevent damage to LED component.
- The closest LED is allowed to solder on board is 1.59mm below the body (encapsulant epoxy) for those parts without standoffs.
- Recommended soldering condition:

	Wave Soldering	Manual Solder Dipping
Pre-heat temperature	105 °C Max.	-
Pre-heat time	30 sec Max.	-
Peak temperature	250 °C Max.	260 °C Max.
Dwell time	3 sec Max.	5 sec Max.

- Wave soldering parameter must be set and maintain according to recommended temperature and dwell time in the solder wave. Customer is advised to periodically check on the soldering profile to ensure the soldering profile used is always conforming to recommended soldering condition.
- If necessary, use fixture to hold the LED component in proper orientation with respect to the PCB during soldering process.
- Proper handling is imperative to avoid excessive thermal stresses to LED components when heated. Therefore, the soldered PCB must be allowed to cool to room temperature, 25 °C before handling.
- Special attention must be given to board fabrication, solder masking, surface plating and lead holes size and component orientation to assure solderability.
- Recommended PC board plated through hole size for LED component leads:

LED component lead size	Diagonal	Plated through hole diameter
0.457 x 0.457 mm (0.025 inch)	(0.018 x 0.018 inch) 0.976 to 1.078 mm	0.646 mm (0.038 to 0.042 inch)
0.508 x 0.508 mm (0.028 inch)	(0.020 x 0.020 inch) 1.049 to 1.150 mm	0.718 mm (0.041 to 0.045 inch)

Note: Refer to application note AN1027 for more information on soldering LED components.

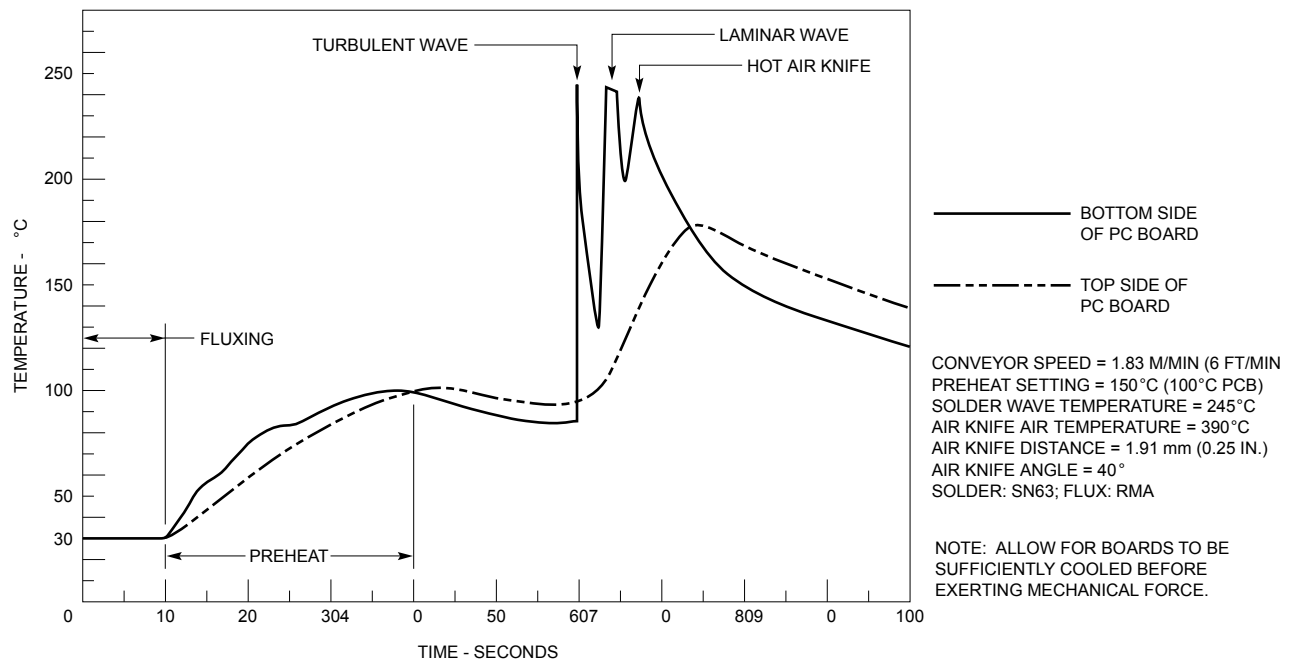

For product information and a complete list of distributors, please go to our web site: www.avagotech.com

Avago, Avago Technologies, and the A logo are trademarks of Avago Technologies, Limited in the United States and other countries.
Data subject to change. Copyright © 2007 Avago Technologies Limited. All rights reserved.
AV02-0044EN - January 15, 2007



X-ON Electronics

Largest Supplier of Electrical and Electronic Components

Click to view similar products for [Standard LEDs - Through Hole category:](#)

Click to view products by [Broadcom manufacturer:](#)

Other Similar products are found below :

[LTL-10254W](#) [LTL-1214A](#) [LTL-3251A](#) [LTL-4262N](#) [LTL-433P](#) [LTL-5234](#) [LTL87HTBK](#) [LTL-87HD4B](#) [HLMP-EL30-PS0DD](#)
[1L0532V23G0TD001](#) [NSPW500CS](#) [NTE30036](#) [NTE30044](#) [NTE30059](#) [NTE3020](#) [LD CQDP-1U3U-W5-1-K](#) [LO566UHR3-70G-A3](#)
[LP379PPG1C0G0300001](#) [SLX-LX3044GD](#) [SLX-LX3044ID](#) [SLX-LX3044YD](#) [1.90690.3330000](#) [SSS-LX4673ID-410B](#) [1L0532Y24I0TD001](#)
[264-7SYGD/S530-E2](#) [HLMP1385](#) [LTL-10224W](#) [LTL-1224A](#) [LTL-1234A](#) [LTL-2251AT](#) [LTL-307YE-012](#) [LTL-403HR](#) [LTL-4222](#) [LU7-E-](#)
[B](#) [4380H1](#) [TLHY44K1L2](#) [HLMP-3962-F0002](#) [HLMP-GG15-R0000](#) [323-2SURD/S530-A3](#) [L53SRC/E-Z](#) [L-7679C1ZGC](#) [4302T1-5V](#)
[4306D23](#) [4363D1/5](#) [WP1503SRC/J4](#) [WP153GDT](#) [WP153YDT](#) [WP1543SGC](#) [WP1543SURC](#) [WP53MGD](#)