

# HLMP-RD11/SD11/RG10/SG10/RL10/SL10

## 4 mm Super Oval Precision Optical Performance

### AllnGaP LEDs



## Data Sheet



### Description

These Precision Optical Performance Oval LEDs are specifically designed for Full Color/Video and Passenger Information signs. The oval shaped radiation pattern (60° x 120°) and high luminous intensity ensure that these devices are excellent for wide field of view outdoor applications where a wide viewing angle and readability in sunlight are essential. These lamps have very smooth, matched radiation patterns ensuring consistent color mixing in full color applications, message uniformity across the viewing angle of the sign.

High efficiency LED materials are used in these lamps: Aluminum Indium Gallium Phosphide (AllnGaP) for Red and Amber color. There are two families of red and amber lamps, AllnGaP and the higher performance AllnGaP II. Each lamp is made with an advanced optical grade epoxy offering superior high temperature and high moisture resistance in outdoor applications. The package epoxy contains both uv-a and uv-b inhibitors to reduce the effects of long term exposure to direct sunlight.

Designers can select parallel (where the axis of the leads is parallel to the wide axis of the oval radiation pattern) or perpendicular orientation. Both lamps are available in tinted version.

### Features

- Well defined spatial radiation pattern
- Viewing angle:  
major axis 120°  
minor axis 60°
- High luminous output
- Two red and amber intensity levels:  
AllnGaP (bright) and AllnGaP II (brightest)
- Colors:  
626/630 nm red  
590/592 nm amber
- Superior resistance to moisture
- UV resistant epoxy

### Applications

- Full color signs

### Benefits

- Viewing angle designed for wide field of view applications
- Superior performance for outdoor environments

# Package Dimensions

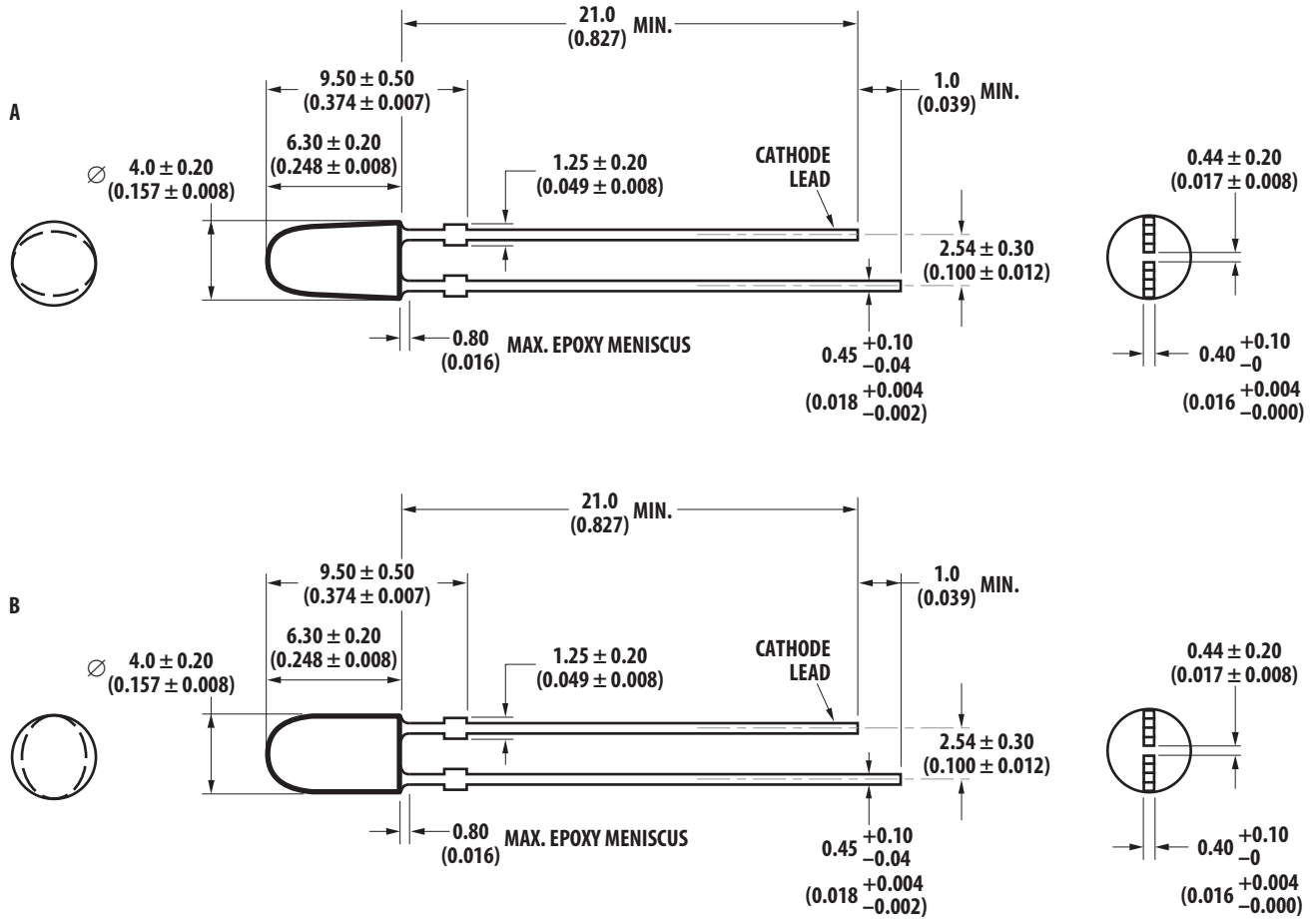

Dimensions are in millimeters (inches).

## Device Selection Guide for AlInGaP

Part Number	Color and Dominant Wavelength $\lambda_d$ (nm) Typ.	Luminous Intensity $I_v$ (mcd) at 20 mA		Leads with Stand-Off	Leadframe Orientation	Package Drawing
		Min.	Max.			
HLMP-SG10-JM0xx	Red 626	240	680	Yes	Perpendicular	A
HLMP-RG10-JM000	Red 626	240	680	Yes	Parallel	B
HLMP-SL10-HL0DD	Amber 590	180	520	Yes	Perpendicular	A
HLMP-SL10-LM0DD	Amber 590	400	680	Yes	Perpendicular	A
HLMP-SL10-LMKDD	Amber 590	400	680	Yes	Perpendicular	A
HLMP-SL10-LMLDD	Amber 590	400	680	Yes	Perpendicular	A
HLMP-SL10-LP0xx	Amber 590	400	1150	Yes	Perpendicular	A
HLMP-SL10-LPKDD	Amber 590	400	1150	Yes	Perpendicular	A
HLMP-SL10-MNKxx	Amber 590	520	880	Yes	Perpendicular	A
HLMP-SL10-MP0DD	Amber 590	520	1150	Yes	Perpendicular	A
HLMP-SL10-MQ0DD	Amber 590	520	1500	Yes	Perpendicular	A
HLMP-SL10-MQLDD	Amber 590	520	1500	Yes	Perpendicular	A
HLMP-RL10-LMLDD	Amber 590	400	680	Yes	Parallel	B
HLMP-RL10-LP0xx	Amber 590	400	1150	Yes	Parallel	B
HLMP-RL10-MP0DD	Amber 590	520	1150	Yes	Parallel	B
HLMP-RL10-MQLDD	Amber 590	520	1500	Yes	Parallel	B

### Notes:

1. The luminous intensity is measured on the mechanical axis of the lamp package.
2. The optical axis is closely aligned with the package mechanical axis.
3. The dominant wavelength,  $\lambda_d$ , is derived from the CIE Chromaticity Diagram and represents the color of the lamp.

## Device Selection Guide for AlInGaP II

Part Number	Color and Dominant Wavelength $\lambda_d$ (nm) Typ.	Luminous Intensity $I_v$ (mcd) at 20 mA		Leads with Stand-Offs	Leadframe Orientation	Package Drawing
		Min.	Max.			
HLMP-RD11-J0000	Red 630	240	-		Yes	Parallel B
HLMP-RD11-LP0xx	Red 630	40	1150	Yes	Parallel	B
HLMP-RD11-LPTxx	Red 630	400	1150	Yes	Parallel	B
HLMP-SD11-J0000	Red 630	240	-	Yes	Perpendicular	A
HLMP-SD11-LP000	Red 630	400	1150	Yes	Perpendicular	A
HLMP-SD11-LPTxx	Red 630	400	1150	Yes	Perpendicular	A
HLMP-SD11-MN0xx	Red 630	520	880	Yes	Perpendicular	A
HLMP-SD11-MNTxx	Red 630	520	880	Yes	Perpendicular	A

### Notes:

1. The luminous intensity is measured on the mechanical axis of the lamp package.
2. The optical axis is closely aligned with the package mechanical axis.
3. The dominant wavelength,  $\lambda_d$ , is derived from the CIE Chromaticity Diagram and represents the color of the lamp.

## Part Numbering System

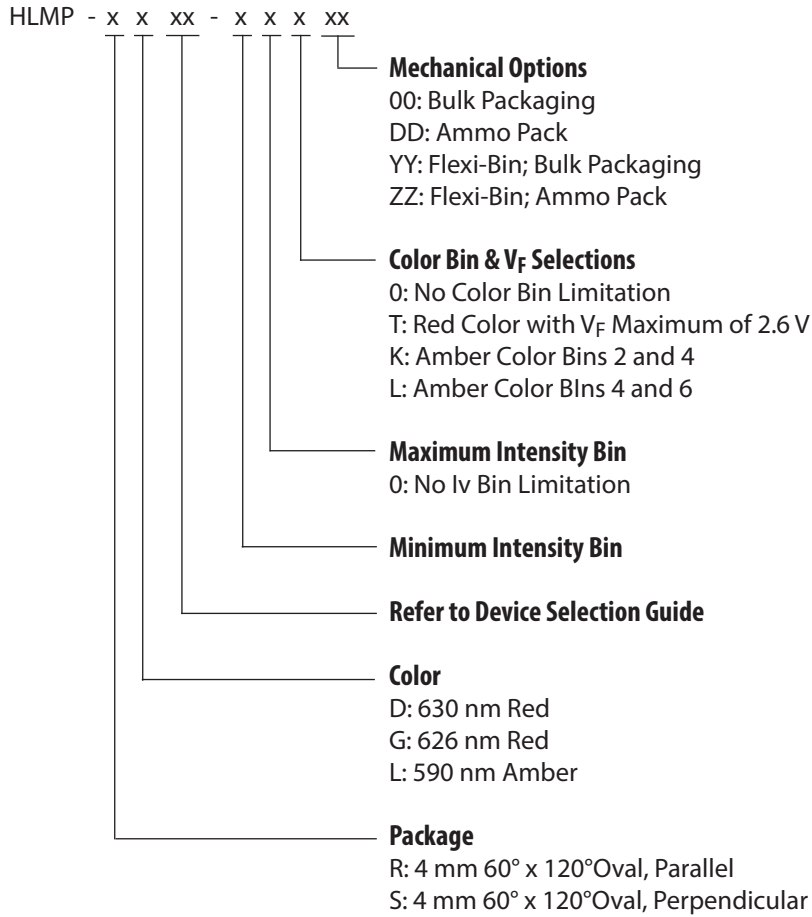

## Absolute Maximum Ratings

$T_A = 25^\circ\text{C}$

Parameter	Amber and Red
DC Forward Current <sup>1</sup>	50 mA
Peak Pulsed Forward Current	100 mA
Average Forward Current	30 mA
Reverse Voltage ( $I_R = 100 \mu\text{A}$ )	5 V
Power Dissipation	120 mW
LED Junction Temperature	130°C
Operating Temperature Range	-40°C to +100°C
Storage Temperature Range	-40°C to +100°C

Note:

1. Derate linearly as shown in Figures 4.

## Electrical/Optical Characteristics

$T_A = 25^\circ\text{C}$

Parameter	Symbol	Min.	Typ.	Max.	Units	Test Conditions
Typical Viewing Angle <sup>[1]</sup>	$2\theta_{1/2}$				deg	
Major			120			
Minor			60			
Forward Voltage	$V_F$				V	$I_F = 20\text{ mA}$
Red ( $\lambda_d = 626\text{ nm}$ )			1.9	2.4		
Red ( $\lambda_d = 630\text{ nm}$ )			2.0	2.4 <sup>[2]</sup>		
Amber ( $\lambda_d = 590\text{ nm}$ )			2.02	2.4		
Reverse Voltage	$V_R$				V	$I_R = 100\ \mu\text{A}$
Amber and Red		5	20			
Peak Wavelength	$\lambda_{\text{PEAK}}$				nm	Peak of Wavelength of Spectral Distribution at $I_F = 20\text{ mA}$
Red ( $\lambda_d = 626\text{ nm}$ )			635			
Red ( $\lambda_d = 630\text{ nm}$ )			639			
Amber ( $\lambda_d = 590\text{ nm}$ )			592			
Spectral Halfwidth	$\Delta\lambda_{1/2}$				nm	Wavelength Width at Spectral Distribution $1/2$ Power Point at $I_F = 20\text{ mA}$
Red ( $\lambda_d = 626/630\text{ nm}$ )			17			
Amber ( $\lambda_d = 590\text{ nm}$ )			17			
Capacitance	C				pF	$V_F = 0, F = 1\text{ MHz}$
All Colors			40			
Thermal Resistance	$R\theta_{\text{J-PIN}}$				$^\circ\text{C/W}$	LED Junction-to-Cathode Lead
All Colors			240			
Luminous Efficacy <sup>[3]</sup>	$\eta_v$				lm/W	Emitted Luminous Power/Emitted Radiant Power
Red ( $\lambda_d = 626\text{ nm}$ )			150			
Red ( $\lambda_d = 630\text{ nm}$ )			155			
Amber ( $\lambda_d = 590\text{ nm}$ )			480			

Notes:

- $2\theta_{1/2}$  is the off-axis angle where the luminous intensity is the on-axis intensity.
- For options -xxRxx, -xxTxx, and -xxVxx, maximum forward voltage,  $V_F$ , is 2.6 V. Please refer to  $V_F$  Bin Table below.
- The radiant intensity,  $I_e$ , in watts per steradian, may be found from the equation  $I_e = I_v/\eta_v$ , where  $I_v$  is the luminous intensity in candelas and  $\eta_v$  is the luminous efficacy in lumens/watt.

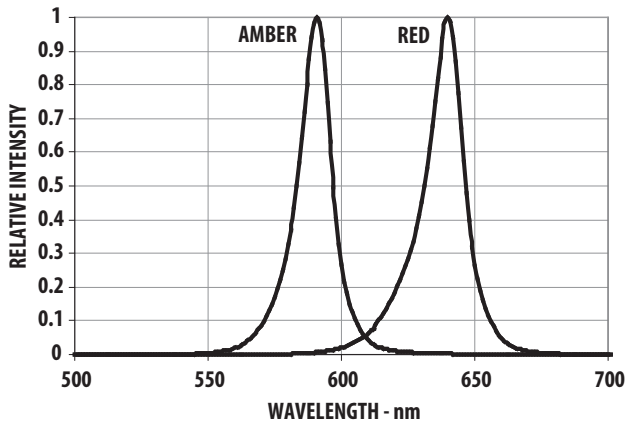

Figure 1. Relative intensity vs. wavelength.

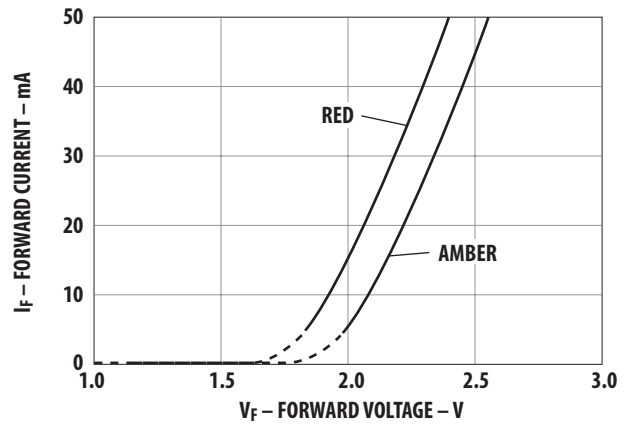

Figure 2. Amber, Red forward current vs. forward voltage.

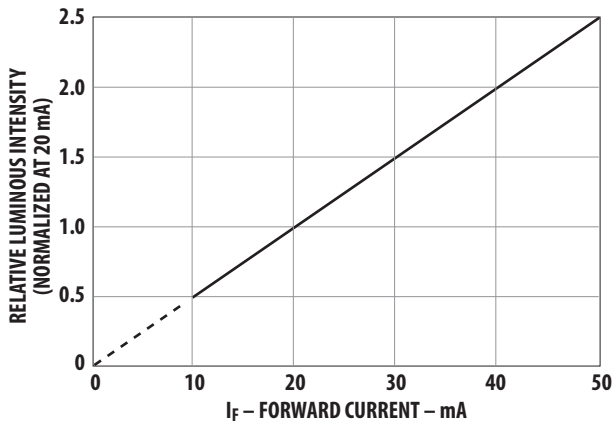

Figure 3. Amber, Red relative luminous intensity vs. forward current.

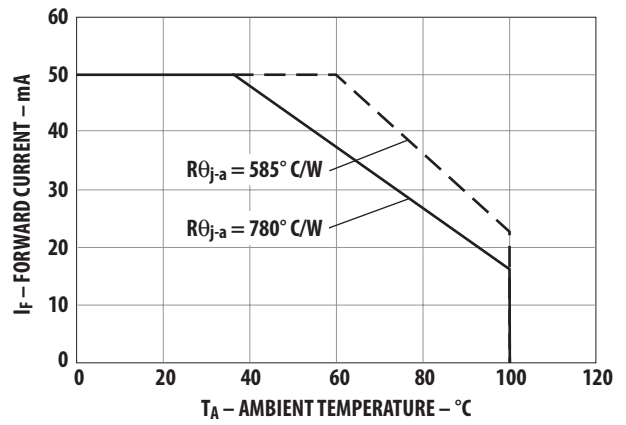

Figure 4. Amber, Red maximum forward current vs. ambient temperature.

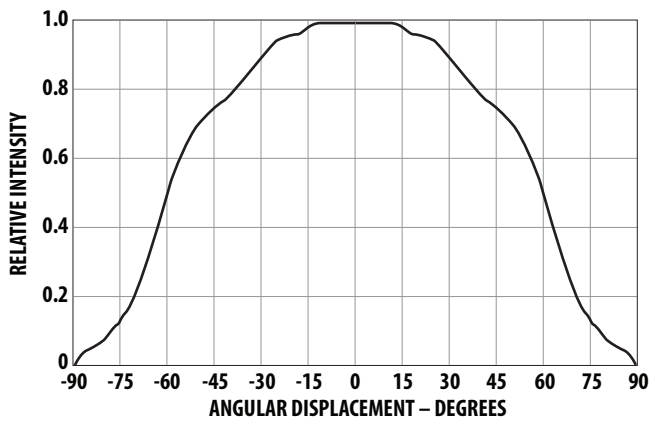

Figure 5a. Representative spatial radiation pattern for major axis.

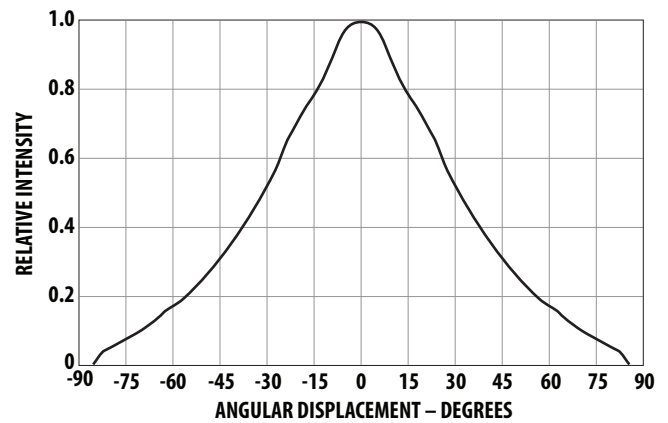

Figure 5b. Representative spatial radiation pattern for minor axis.

## Intensity Bin Limits

(mcd at 20 mA)

Bin Name	Min.	Max.
H	180	240
J	240	310
K	310	400
L	400	520
M	520	680
N	680	880
P	880	1150

Tolerance for each bin limit is  $\pm 15\%$ .

## VF Bin Table<sup>2</sup>

Bin Name	Min.	Max.
VA	2.0	2.2
VB	2.2	2.4
VC	2.4	2.6

Tolerance for each bin is  $\pm 0.05$  V.

Note:

1. Bin categories are established for classification of products. Products may not be available in all bin categories.
2. VF binning is applicable for part numbers with option -xxTxx.

## Color Bin Limits

(nm at 20 mA)

Amber	Colour Range (nm)	
Bin ID	Min.	Max.
1	584.5	587.0
2	587.0	589.5
4	589.5	592.0
6	592.0	594.5

Tolerance for each bin limit is  $\pm 0.5$  nm.

Note:

1. All bin categories are established for classification of products. Products may not be available in all bin categories. Please contact your Avago representatives for further information.

## Precautions:

### Lead Forming:

- The leads of an LED lamp may be preformed or cut to length prior to insertion and soldering on PC board.
- For better control, it is recommended to use proper tool to precisely form and cut the leads to applicable length rather than doing it manually.
- If manual lead cutting is necessary, cut the leads after the soldering process. The solder connection forms a mechanical ground which prevents mechanical stress due to lead cutting from traveling into LED package. This is highly recommended for hand solder operation, as the excess lead length also acts as small heat sink.

### Soldering and Handling:

- Care must be taken during PCB assembly and soldering process to prevent damage to the LED component.
- LED component may be effectively hand soldered to PCB. However, it is only recommended under unavoidable circumstances such as rework. The closest manual soldering distance of the soldering heat source (soldering iron's tip) to the body is 1.59mm. Soldering the LED using soldering iron tip closer than 1.59mm might damage the LED.

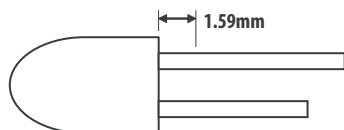

- ESD precaution must be properly applied on the soldering station and personnel to prevent ESD damage to the LED component that is ESD sensitive. Do refer to Avago application note AN 1142 for details. The soldering iron used should have grounded tip to ensure electrostatic charge is properly grounded.
- Recommended soldering condition:

	Wave Soldering [1, 2]	Manual Solder Dipping
Pre-heat temperature	105 °C Max.	-
Preheat time	60 sec Max	-
Peak temperature	250 °C Max.	260 °C Max.
Dwell time	3 sec Max.	5 sec Max

#### Note:

- 1) Above conditions refers to measurement with thermocouple mounted at the bottom of PCB.
  - 2) It is recommended to use only bottom preheaters in order to reduce thermal stress experienced by LED.
- Wave soldering parameters must be set and maintained according to the recommended temperature and dwell time. Customer is advised to perform daily check on the soldering profile to ensure that it is always conforming to recommended soldering conditions.

#### Note:

1. PCB with different size and design (component density) will have different heat mass (heat capacity). This might cause a change in temperature experienced by the board if same wave soldering setting is used. So, it is recommended to re-calibrate the soldering profile again before loading a new type of PCB.
2. Avago Technologies' high brightness LED are using high efficiency LED die with single wire bond as shown below. Customer is advised to take extra precaution during wave soldering to ensure that the maximum wave temperature does not exceed 250°C and the solder contact time does not exceeding 3sec. Over-stressing the LED during soldering process might cause premature failure to the LED due to delamination.

### Avago Technologies LED configuration

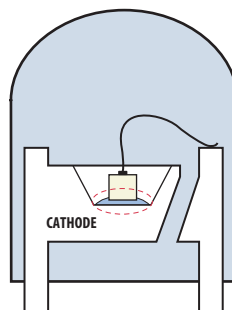

Note: Electrical connection between bottom surface of LED die and the lead frame is achieved through conductive paste.

- Any alignment fixture that is being applied during wave soldering should be loosely fitted and should not apply weight or force on LED. Non metal material is recommended as it will absorb less heat during wave soldering process.
- At elevated temperature, LED is more susceptible to mechanical stress. Therefore, PCB must allowed to cool down to room temperature prior to handling, which includes removal of alignment fixture or pallet.
- If PCB board contains both through hole (TH) LED and other surface mount components, it is recommended that surface mount components be soldered on the top side of the PCB. If surface mount need to be on the bottom side, these components should be soldered using reflow soldering prior to insertion the TH LED.
- Recommended PC board plated through holes (PTH) size for LED component leads.

LED component lead size	Diagonal	Plated through hole diameter
0.45 x 0.45 mm (0.018x 0.018 inch)	0.636 mm (0.025 inch)	0.98 to 1.08 mm (0.039 to 0.043 inch)
0.50 x 0.50 mm (0.020x 0.020 inch)	0.707 mm (0.028 inch)	1.05 to 1.15 mm (0.041 to 0.045 inch)

- Over-sizing the PTH can lead to twisted LED after clinching. On the other hand under sizing the PTH can cause difficulty inserting the TH LED.



Refer to application note AN5334 for more information about soldering and handling of high brightness TH LED lamps.

### Example of Wave Soldering Temperature Profile for TH LED

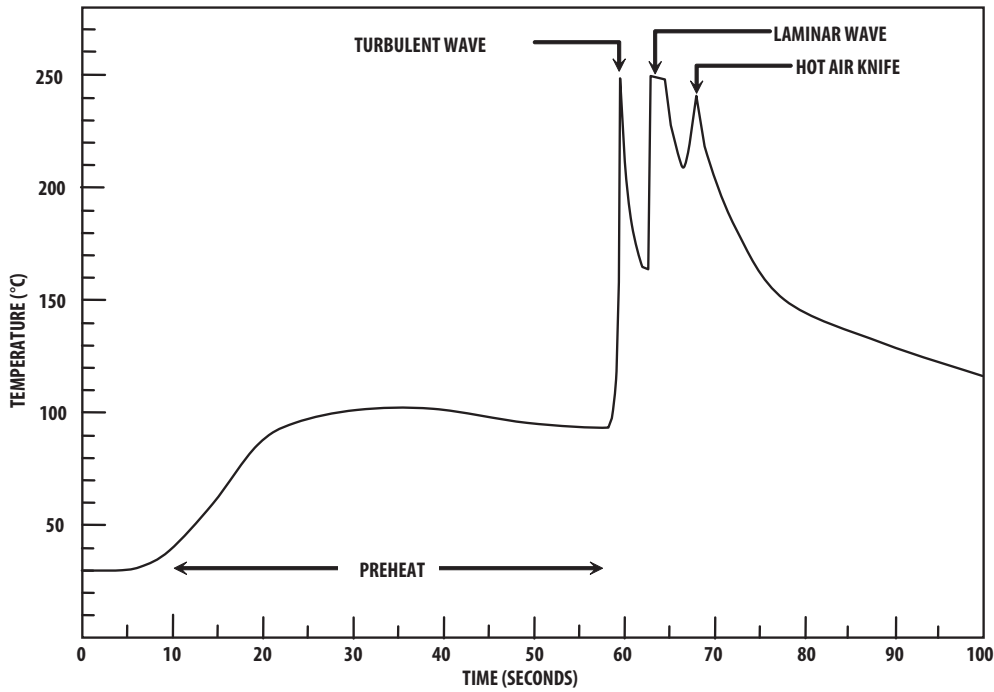

Recommended solder:  
 Sn63 (Leaded solder alloy)  
 SAC305 (Lead free solder alloy)

Flux: Rosin flux

Solder bath temperature:  
 245°C ± 5°C (maximum peak  
 temperature = 250°C)

Dwell time: 1.5 sec - 3.0 sec  
 (maximum = 3sec)

Note: Allow for board to be sufficiently cooled to room temperature before exerting mechanical force.

### Ammo Packs Drawing

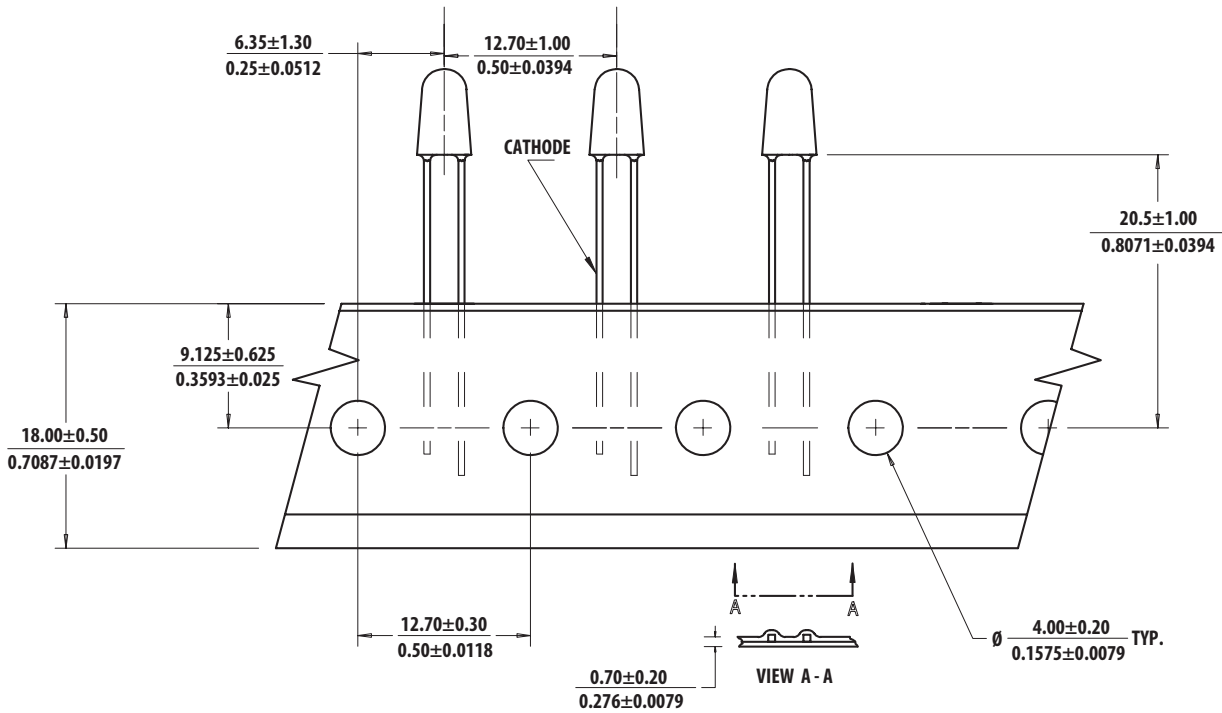

Note: The ammo-packs drawing is applicable for packaging option -DD & -ZZ and regardless standoff or non-standoff

## Packaging Box for Ammo Packs

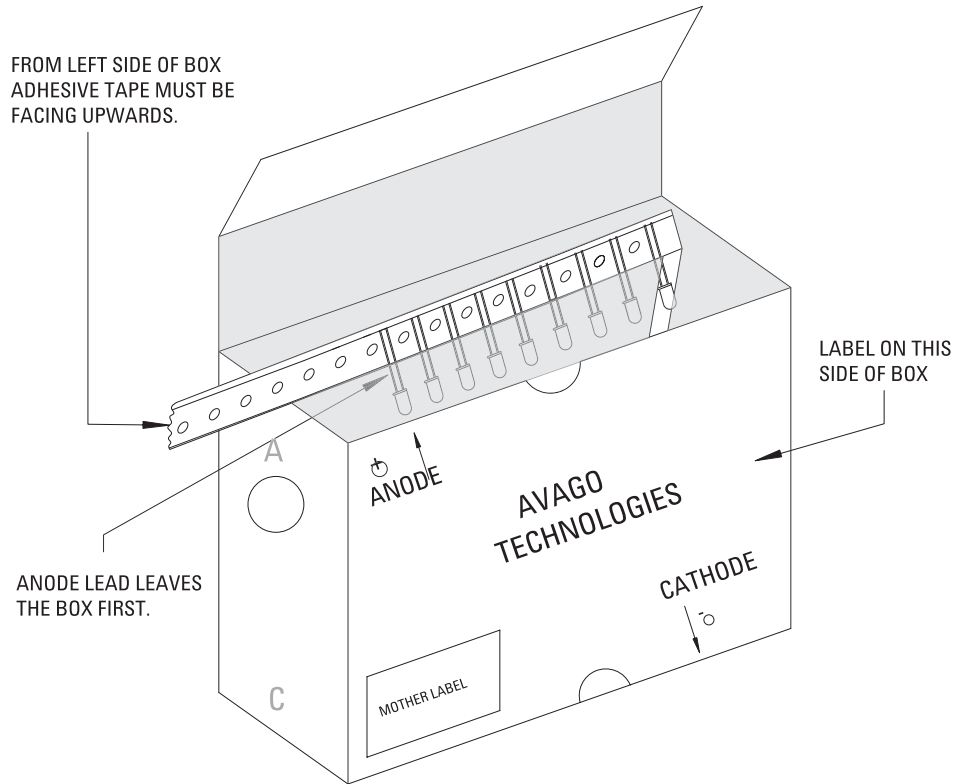











Note: For InGaN device, the ammo pack packaging box contain ESD logo

## Packaging Label

(i) Avago Mother Label: (Available on packaging box of ammo pack and shipping box)

<b>AVAGO</b> TECHNOLOGIES	
(1P) Item: <b>Part Number</b>	STANDARD LABEL LS0002
	RoHS Compliant
(1T) Lot: <b>Lot Number</b>	e3 max temp 250C
	(Q) QTY: <b>Quantity</b>
LPN:	
	CAT: <b>Intensity Bin</b>
(9D)MFG Date: <b>Manufacturing Date</b>	
	BIN: <b>Refer to below information</b>
<hr/>	
(P) Customer Item:	
(V) Vendor ID:	(9D) Date Code: <b>Date Code</b>
DeptID:	Made In: <b>Country of Origin</b>

(ii) Avago Baby Label (Only available on bulk packaging)

		RoHS Compliant e3 max temp 250C
<b>Lamps Baby Label</b>		
(1P) PART #: Part Number		
		
(1T) LOT #: Lot Number		
		
(9D)MFG DATE: Manufacturing Date	QUANTITY: Packing Quantity	
		
C/O: Country of Origin		
Customer P/N:	CAT: Intensity Bin	
		
Supplier Code:	BIN: Refer to below information	
		
	DATECODE: Date Code	
		

**Acronyms and Definition:**

BIN:

- (i) Color bin only or VF bin only  
 (Applicable for part number with color bins but without VF bin OR part number with VF bins and no color bin)  
 OR
- (ii) Color bin incorporated with VF Bin  
 (Applicable for part number that have both color bin and VF bin)

**Example:**

- (i) Color bin only or VF bin only  
 BIN: 2 (represent color bin 2 only)  
 BIN: VB (represent VF bin "VB" only)
- (ii) Color bin incorporate with VF Bin  
 BIN: 2VB

**DISCLAIMER**

AVAGO'S PRODUCTS AND SOFTWARE ARE NOT SPECIFICALLY DESIGNED, MANUFACTURED OR AUTHORIZED FOR SALE AS PARTS, COMPONENTS OR ASSEMBLIES FOR THE PLANNING, CONSTRUCTION, MAINTENANCE OR DIRECT OPERATION OF A NUCLEAR FACILITY OR FOR USE IN MEDICAL DEVICES OR APPLICATIONS. CUSTOMER IS SOLELY RESPONSIBLE, AND WAIVES ALL RIGHTS TO MAKE CLAIMS AGAINST AVAGO OR ITS SUPPLIERS, FOR ALL LOSS, DAMAGE, EXPENSE OR LIABILITY IN CONNECTION WITH SUCH USE.

For product information and a complete list of distributors, please go to our web site: [www.avagotech.com](http://www.avagotech.com)

## X-ON Electronics

Largest Supplier of Electrical and Electronic Components

*Click to view similar products for [Standard LEDs - Through Hole category](#):*

*Click to view products by [Broadcom manufacturer](#):*

Other Similar products are found below :

[LTL-10254W](#) [LTL-1214A](#) [LTL-3251A](#) [LTL-4262N](#) [LTL-433P](#) [LTL-5234](#) [LTL87HTBK](#) [LTL-87HD4B](#) [HLMP-EL30-PS0DD](#)  
[1L0532V23G0TD001](#) [NSPW500CS](#) [NTE30036](#) [NTE30044](#) [NTE30059](#) [NTE3020](#) [LD CQDP-1U3U-W5-1-K](#) [LO566UHR3-70G-A3](#)  
[LP379PPG1C0G0300001](#) [SLX-LX3044GD](#) [SLX-LX3044ID](#) [SLX-LX3044YD](#) [1.90690.3330000](#) [SSS-LX4673ID-410B](#) [1L0532Y24I0TD001](#)  
[264-7SYGD/S530-E2](#) [HLMP1385](#) [LTL-10224W](#) [LTL-1224A](#) [LTL-1234A](#) [LTL-2251AT](#) [LTL-307YE-012](#) [LTL-403HR](#) [LTL-4222](#) [LU7-E-](#)  
[B](#) [4380H1](#) [TLHY44K1L2](#) [HLMP-3962-F0002](#) [HLMP-GG15-R0000](#) [323-2SURD/S530-A3](#) [L53SRC/E-Z](#) [L-7679C1ZGC](#) [4302T1-5V](#)  
[4306D23](#) [4363D1/5](#) [WP1503SRC/J4](#) [WP153GDT](#) [WP153YDT](#) [WP1543SGC](#) [WP1543SURC](#) [WP53MGD](#)