

## Data Sheet

### Description

The HSMF-C114 tricolor chip-type LED is designed in an ultra small package for miniaturization. It is the first of its kind to achieve such small packaging and be the thinnest package in the industry for tricolor package. With the freedom to have any combination of colors from mixing of the 3 primary colors, this will yield a wide variety of colors to suit every application and product theme.

The small size, narrow footprint, and low profile make this LED excellent for back-lighting, status indication, and front panel illumination applications.

In order to facilitate pick and place operation, this ChipLED is shipped in tape and reel, with 4000 units per reel. The package is compatible with reflow soldering and binned by both color and intensity.

### Features

- Common anode
- Small 1.6 x 1.5 x 0.35 mm package
- Diffused optics
- Red/Green/Blue color combination
- Available in 8 mm tape on 7" diameter reels
- High brightness using AlInGaP and InGaN die technology
- Compatible with reflow soldering

### Applications

- Backlighting
- Status indicator
- Front panel indicator
- Office automation, home appliances, industrial equipment

**CAUTION:** It is advised that normal static precautions be taken in handling and assembly of this component to prevent damage and/or degradation which may be induced by ESD.

## Package Dimensions

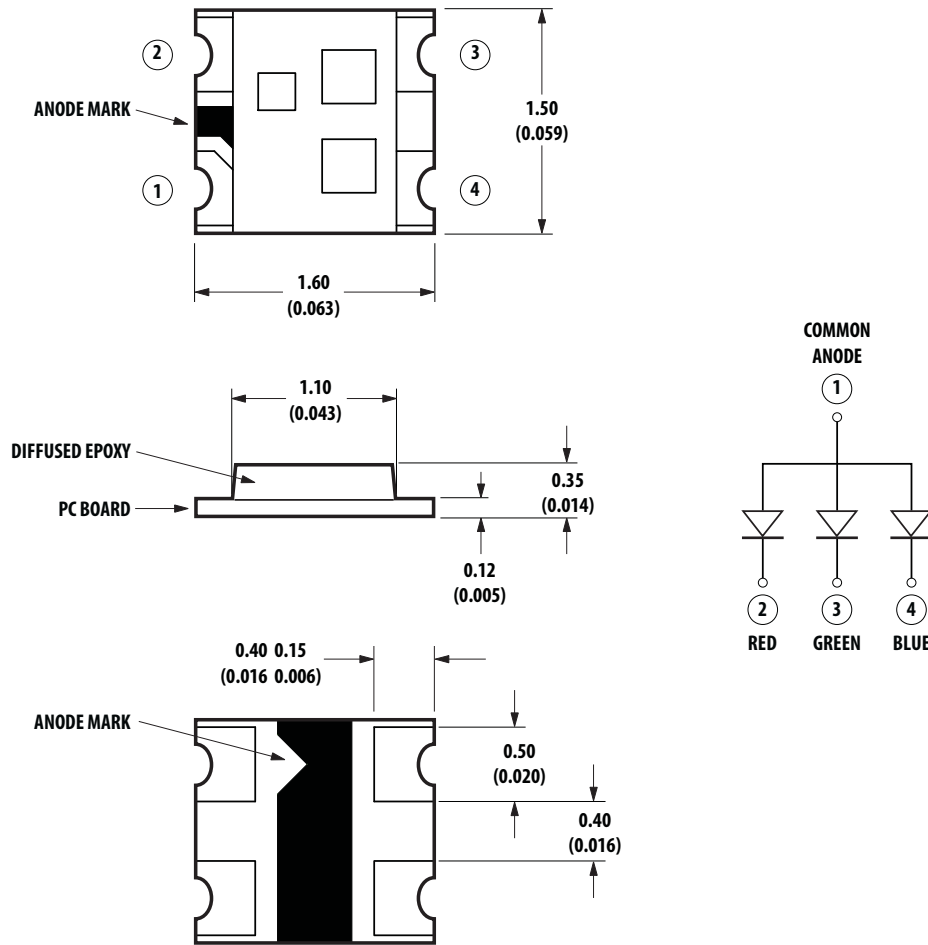

### NOTES:

1. ALL DIMENSIONS IN MILLIMETERS (INCHES).
2. TOLERANCE IS 0.1 mm ( 0.004 IN.) UNLESS OTHERWISE SPECIFIED.

## Absolute Maximum Ratings at $T_A = 25^\circ\text{C}$

| Parameter                                   | AllInGaP Red                                 | InGaN Green | InGaN Blue | Units            |
|---|--|-------------|------------|------------------|
| DC Forward Current <sup>[1,3]</sup>         | 20   | 20          | 20         | mA               |
| Power Dissipation <sup>[1]</sup>            | 48   | 78          | 78         | mW               |
| DC Forward Current <sup>[2]</sup>           | 15   | 15          | 15         | mA               |
| Power Dissipation <sup>[2]</sup>            | 36   | 59          | 59         | mW               |
| Reverse Voltage ( $I_R = 100 \mu\text{A}$ ) | 5  | 5           | 5          | V                |
| LED Junction Temperature                    | 95   | 95          | 95         | $^\circ\text{C}$ |
| Operating Temperature Range                 |  | -40 to 85   |            | $^\circ\text{C}$ |
| Storage Temperature Range                   |  | -40 to 85   |            | $^\circ\text{C}$ |
| Soldering Temperature                       | See reflow soldering profile (Figures 6 & 7) |             |            |                  |

### Notes:

1. Applies when single LED is lit up.
2. Applies when all 3 LEDs are lit up simultaneously.
3. Derate linearly as shown in Figure 4.
4. Drive currents above 5 mA are recommended for best long term performance.

### Electrical Characteristics at $T_A = 25^\circ\text{C}$

| Part Number | Forward Voltage $V_F$ (Volts) <sup>[1]</sup><br>@ $I_F = 20\text{ mA}$ |      | Reverse Breakdown<br>$V_R$ (Volts) @ $I_R = 100\ \mu\text{A}$ | Capacitance<br>$C$ (pF), @ $V_F = 0$ , $f = 1\text{ MHz}$ |
|-------------|--|------|---|---|
|             | Typ.   | Max. | Min.  | Typ.  |
| AllnGaP Red | 1.9  | 2.4  | 5   | 10  |
| InGaN Green | 3.4  | 3.9  | 5   | 65  |
| InGaN Blue  | 3.4  | 3.9  | 5   | 65  |

Note:

1.  $V_F$  tolerance:  $\pm 0.1\text{ V}$ .

### Optical Characteristics at $T_A = 25^\circ\text{C}$

| Part Number | Luminous Intensity<br>$I_V$ <sup>[1]</sup> (mcd) @ 20 mA |       | Peak<br>Wavelength<br>$\lambda_{\text{peak}}$ (nm) | Color, Dominant<br>Wavelength<br>$\lambda_d$ <sup>[2]</sup> (nm) | Viewing Angle<br>$2\theta_{1/2}$ <sup>[3]</sup><br>(Degrees) | Luminous<br>Efficacy<br>$\eta_V$ (lm/W) |
|-------------|--|-------|--|--|--|---|
|             | Min.   | Typ.  | Typical  | Typical  | Typical  | Typical                                 |
| AllnGaP Red | 28.5   | 85.0  | 637  | 626  | 140  | 155                                     |
| InGaN Green | 45.0   | 180.0 | 523  | 525  | 145  | 477                                     |
| InGaN Blue  | 28.5   | 70.0  | 468  | 470  | 145  | 75                                      |

Notes:

1. The luminous intensity  $I_V$  is measured at the peak of the spatial radiation pattern which may not be aligned with the mechanical axis of the LED package.
2. The dominant wavelength,  $\lambda_d$ , is derived from the CIE Chromaticity Diagram and represents the perceived color of the device.
3.  $\theta_{1/2}$  is the off-axis angle where the luminous intensity is 1/2 the peak intensity.

### CAUTION:

1. The above optical performance specifications are valid in the case when single LED is lit up.
2. The above product specifications DO NOT provide any guarantee on color mixing, color consistency over time, or uniformity in luminous intensity when more than 1 LED is lit.
3. Please refer to Avago Technologies' Application Brief AB D-007 for additional details/explanation on driving the part in parallel circuit.

### Light Intensity ( $I_v$ ) Bin Limits<sup>[1]</sup>

| Bin ID | Intensity (mcd) |         |
|--------|-----------------|---------|
|        | Minimum         | Maximum |
| A      | 0.11            | 0.18    |
| B      | 0.18            | 0.29    |
| C      | 0.29            | 0.45    |
| D      | 0.45            | 0.72    |
| E      | 0.72            | 1.10    |
| F      | 1.10            | 1.80    |
| G      | 1.80            | 2.80    |
| H      | 2.80            | 4.50    |
| J      | 4.50            | 7.20    |
| K      | 7.20            | 11.20   |
| L      | 11.20           | 18.00   |
| M      | 18.00           | 28.50   |
| N      | 28.50           | 45.00   |
| P      | 45.00           | 71.50   |
| Q      | 71.50           | 112.50  |
| R      | 112.50          | 180.00  |
| S      | 180.00          | 285.00  |
| T      | 285.00          | 450.00  |

Tolerance:  $\pm 15\%$

Note:

1. Bin categories are established for classification of products. Products may not be available in all categories. Please contact your Avago representative for information on current available bins.

### AllnGaP Red Color Bin Limits<sup>[1]</sup>

| Bin ID | Dom. Wavelength (nm) |         |
|--------|----------------------|---------|
|        | Minimum              | Maximum |
| —      | 620.0                | 635.0   |

Tolerance:  $\pm 1$  nm

### InGaN Green Color Bin Limits<sup>[1]</sup>

| Bin ID | Dom. Wavelength (nm) |         |
|--------|----------------------|---------|
|        | Minimum              | Maximum |
| A      | 515.0                | 520.0   |
| B      | 520.0                | 525.0   |
| C      | 525.0                | 530.0   |
| D      | 530.0                | 535.0   |

Tolerance:  $\pm 1$  nm

### InGaN Blue Color Bin Limits<sup>[1]</sup>

| Bin ID | Dom. Wavelength (nm) |         |
|--------|----------------------|---------|
|        | Minimum              | Maximum |
| A      | 460.0                | 465.0   |
| B      | 465.0                | 470.0   |
| C      | 470.0                | 475.0   |
| D      | 475.0                | 480.0   |

Tolerance:  $\pm 1$  nm

Note:

1. Bin categories are established for classification of products. Products may not be available in all categories. Please contact your Avago representative for information on current available bins.

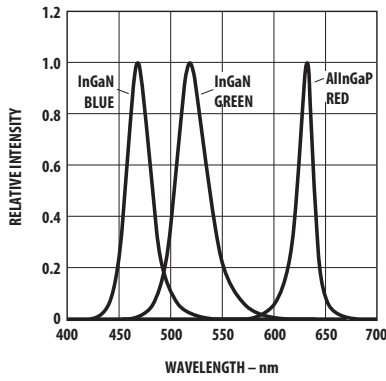

Figure 1. Relative intensity vs. wavelength.

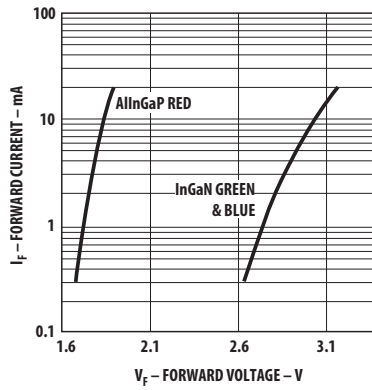

Figure 2. Forward current vs. forward voltage.  
Luminous intensity vs. forward current.

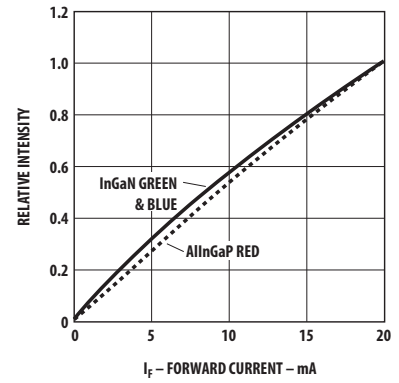

Figure 3. Luminous intensity vs. forward current.

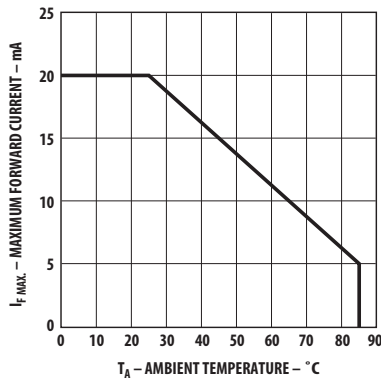

Figure 4. Maximum forward current vs. ambient temperature.

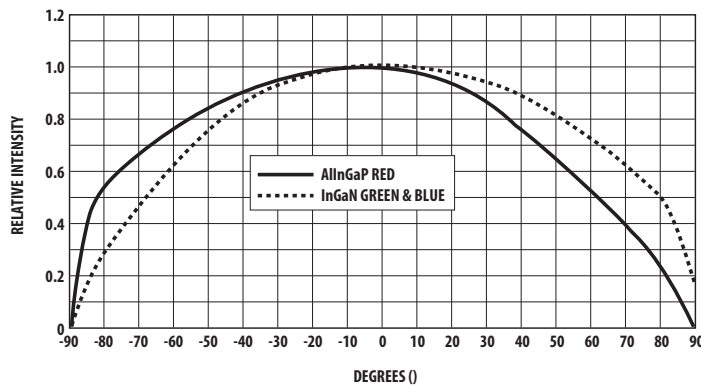

Figure 5. Relative intensity vs. angle.

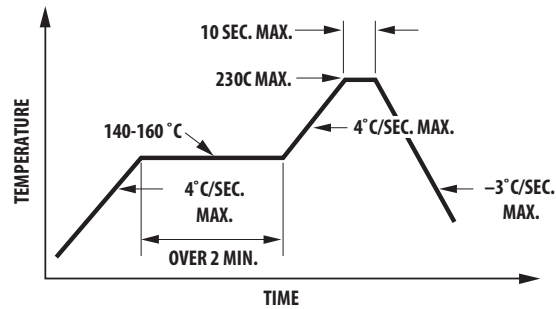

Figure 6. Recommended reflow soldering profile.

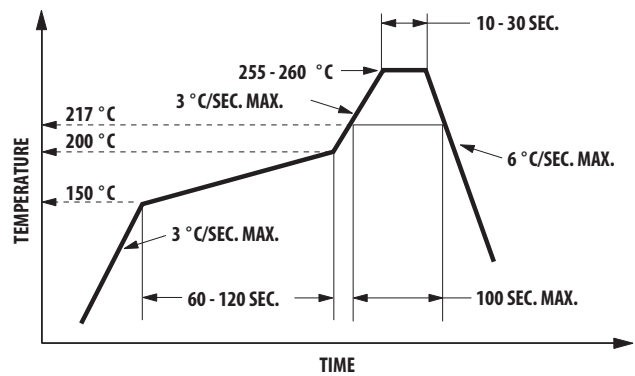

Figure 7. Recommended Pb-free reflow soldering profile.  
(Acc. to J-STD-020C)

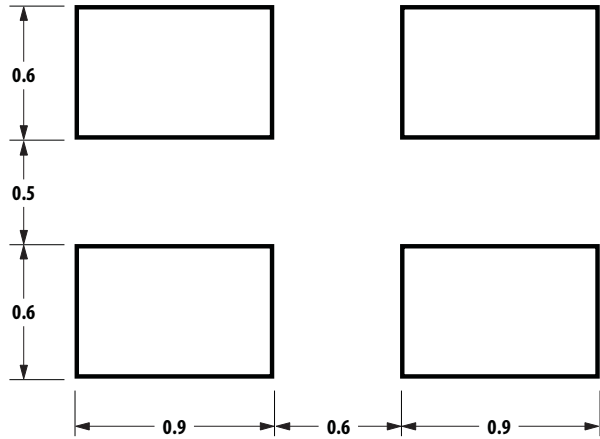

Figure 8. Recommended soldering land pattern.

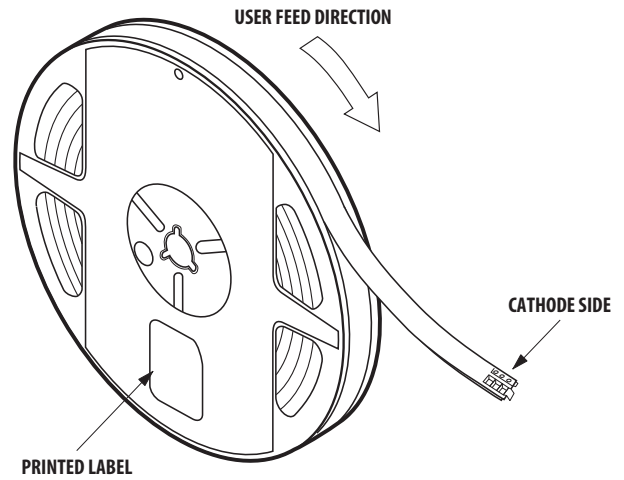
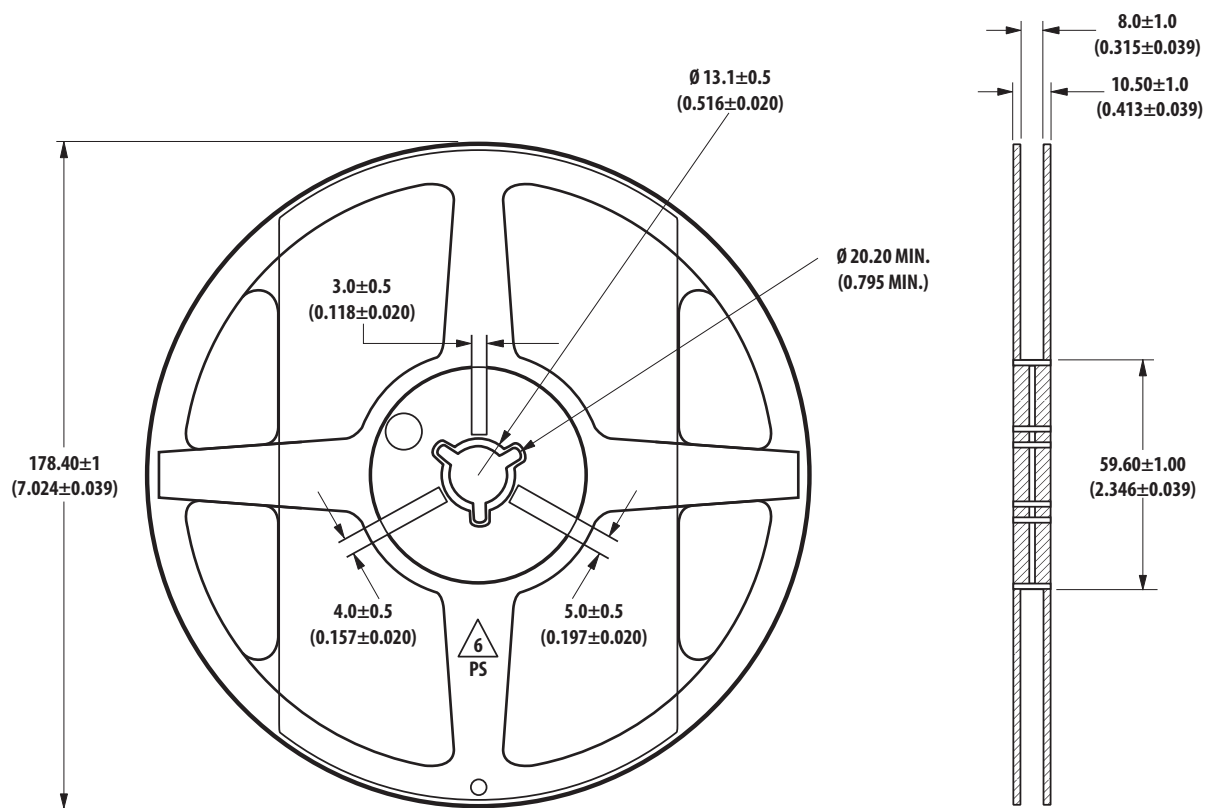

Figure 9. Reeling orientation.



NOTE:  
1. ALL DIMENSIONS IN MILLIMETERS (INCHES).

Figure 10. Reel dimensions.

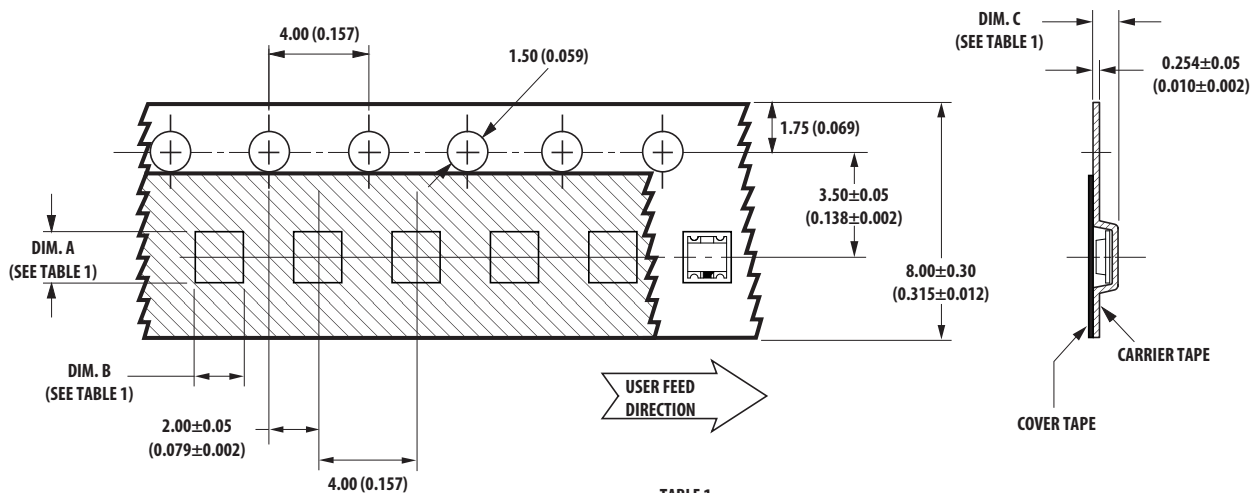

TABLE 1  
DIMENSIONS IN MILLIMETERS (INCHES)

| PART NUMBER | DIM. A<br>±0.10 (±0.004) | DIM. B<br>±0.10 (±0.004) | DIM. C<br>±0.10 (±0.004) |
|-------------|--------------------------|--------------------------|--------------------------|
| HSMF-C114   | 1.75 (0.069)             | 1.65 (0.065)             | 0.55 (0.022)             |

Figure 11. Tape dimensions.

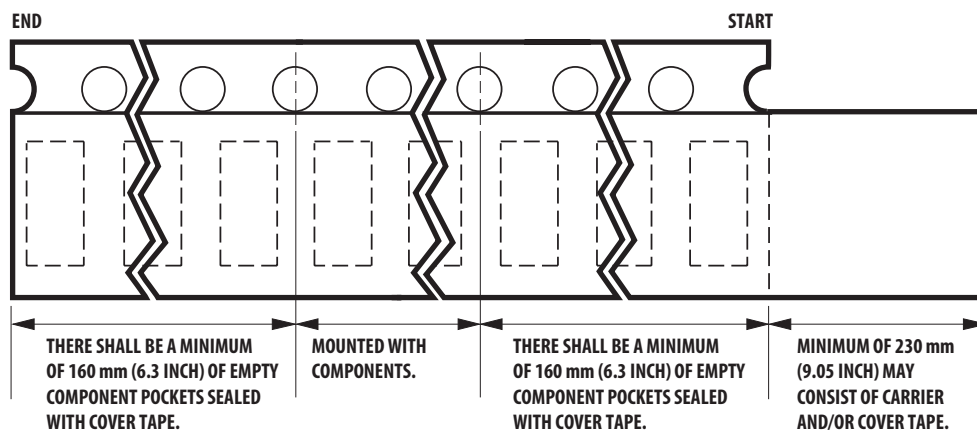

Figure 12. Tape leader and trailer dimensions.

### Convective IR Reflow Soldering

For more information on reflow soldering, refer to Application Note 1060, Surface Mounting SMT LED Indicator Components.

### Storage Condition:

5 to 30°C @ 60% RH max.

Baking is required before mounting if:

1. Humidity Indicator Card is > 10% when read at 23 ± 5°C.
2. Device exposed to factory conditions < 30°C/60% RH more than 672 hours.

Recommended baking condition: 60 ± 5°C for 20 hours.

For product information and a complete list of distributors, please go to our web site: [www.avagotech.com](http://www.avagotech.com)

Avago, Avago Technologies, and the A logo are trademarks of Avago Technologies in the United States and other countries. Data subject to change. Copyright © 2005-2012 Avago Technologies. All rights reserved. Obsoletes 5989-4809EN AV02-2451EN - April 18, 2012



## X-ON Electronics

Largest Supplier of Electrical and Electronic Components

*Click to view similar products for [Standard LEDs - SMD category](#):*

*Click to view products by [Broadcom manufacturer](#):*

Other Similar products are found below :

[LTST-C19GD2WT](#) [LTST-N683GBEW](#) [LTW-170ZDC](#) [LTW-M140SZS40](#) [598-8110-100F](#) [598-8170-100F](#) [598-8610-202F](#) [67-22VRVGC/TR8](#) [AAAF5060QBFSEEZGS](#) [HLMP-6305-L0011](#) [ALMD-LB36-SV002](#) [APT1608QGW](#) [15-21UYC/S530-A3/TR8](#) [EASV1803BA0](#) [LS A676-P2S1-1](#) [SML310BATT86](#) [SML-512VWT86A](#) [SML-LX0606SISUGC/A](#) [SML-LXL1307SRC-TR](#) [SML-LXR851SIUPGUBC](#) [LT1ED53A](#) [FAT801-S](#) [AM27ZGC03](#) [APB3025SGNC](#) [APFA3010SURKCGKQBDC](#) [APHK1608VGCA](#) [APT2012QGW](#) [CLX6D-FKB-CN1R1H1BB7D3D3](#) [LTST-C250KGKT](#) [LTW-020ZDCG](#) [LTW-21TS5](#) [LTW-220DS5](#) [JANTXM19500/521-02](#) [UYGT801-S](#) [LO T67F-V1AB-24-1](#) [YGFR411-H](#) [SML-LX0402IC-TR](#) [CMDA20AYAA7D1S](#) [CMDA16AYDR7A1X](#) [339-1SURYGW/S530-A2](#) [598-8040-100F](#) [598-8070-100F](#) [598-8140-100F](#) [598-8610-200F](#) [EAPL3527GA5](#) [67-11/BHC-M1N2B8Y/2A0](#) [SML-LXL1209SYC/ATR](#) [EASV3020YGA0](#) [EAST16086YA5](#) [CMD91-21VRC/TR7](#)