

MGA-545P8

50 MHz to 7 GHz Medium Power Amplifier



Data Sheet

Description

Avago's MGA-545P8 is an economical, low current, medium power, easy-to-use GaAs MMIC amplifier that offers excellent power output at 5.8 GHz. Although optimized for 5.8 GHz applications, the MGA-545P8 is suitable for other applications in the 50 MHz to 7 GHz frequency range.

With the addition of a simple input match, the MGA-545P8 offers a small signal gain of 11.5 dB, a saturated power output of 22 dBm and a saturated gain of 9.5 dB at 5.8 GHz. The MGA-545P8 has a nominal current consumption of 92 mA in saturated mode and 135 mA in linear mode at a device voltage of 3.3 V with power added efficiency of 46% in saturated mode.

The MGA-545P8 is housed in the 2X2 mm-8L LPCC package. This package offers good thermal dissipation and very good high frequency characteristics making it appropriate for medium power applications through 7 GHz.

Pin Connections and Package Marking

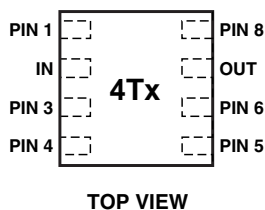
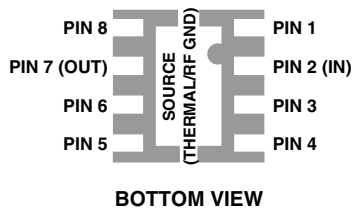

Note: Package marking provides orientation and identification.
"4T" = Device Code
"x" = Date code indicates the month of manufacture.



Attention: Observe precautions for handling electrostatic sensitive devices.
ESD Machine Model = 40 V
ESD Human Body Model = 200 V
Refer to Avago Application Note A004R: Electrostatic Discharge, Damage and Control.

Specifications

- 3.3 V, 92 mA, 5.825 GHz at saturation mode
- 22 dBm saturated power across 1-7 GHz
- 9.5 dB gain
- 46% PAE
- 3.3 V, 135 mA, 5.825 GHz at linear mode
- 11.5 dB small signal gain
- Pout = 16 dBm at 5.6% EVM
- 34 dBm OIP3 at 2.7 V

Features

- Unconditionally stable
- Single +3.3 V operation
- Small package size: 2.0 x 2.0 x 0.75 mm³
- Point MTTF > 300 years [2]
- MSL-1 and Pb-free and Halogen-free
- Tape-and-reel packaging option available

Applications

The MGA-545P8 is ideal for use as IF Amplifier, driver amplifier and power amplifier in:

- 3-4 GHz fixed wireless access (WLL)
- 5-6 GHz fixed wireless access (HiperLAN/UNII)
- 5-6 GHz WLAN 802.11a NIC and AP
- Other applications in the 50 MHz to 7 GHz frequency range

Simplified Schematic

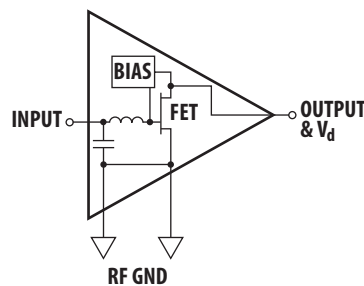

Notes:

1. Enhancement mode technology employs a single positive V_{GS} , eliminating the need of negative gate voltage associated with conventional depletion mode devices.
2. Refer to reliability datasheet for detailed MTTF data.
3. Conform to JEDEC reference outline MO229 for DRP-N.

MGA-545P8 Absolute Maximum Ratings^[1]

Parameter	Units	Absolute Maximum	
V_d	Device Voltage, RF output to ground	V	5.0
P_{in}	CW RF Input Power	dBm	20
θ_{jc}	Thermal Resistance ^[2]	°C/W	124
P_{diss}	Total Power Dissipation ^[3]	W	0.8
T_j	Junction Temperature	°C	150
T_{STG}	Storage Temperature	°C	-65 to 150

Notes:

1. Operation of this device in excess of any of these limits may cause permanent damage.
2. Thermal resistance measured using 150°C Liquid Crystal Measurement Technique.
3. Board (package belly) temperature T_b is 25°C. Derate 8 mW/°C for $T_b > 51^\circ\text{C}$.

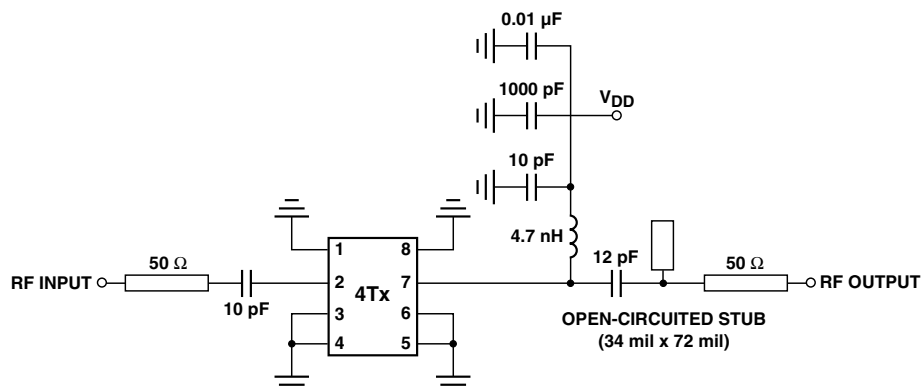

Figure 1. Production test circuit. This circuit represents a match for maximum gain and saturated power.

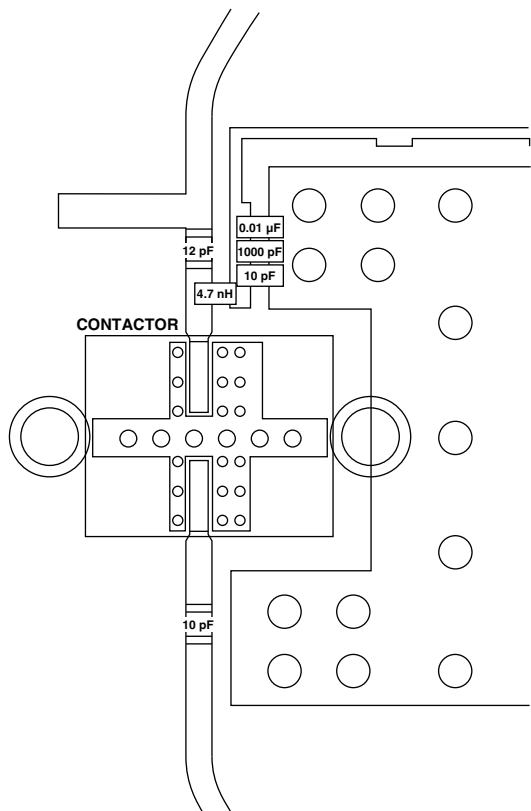

Figure 2. Close-up of production test board. Rogers 4350 Er = 3.48 ± 0.05, thickness = 10 mils.

MGA-545P8 Electrical Specifications

T_c = 25°C, V_d = 3.3 V, unless otherwise noted

Symbol	Parameter and Test Condition		Units	Min.	Typ.	Max.
Gtest_sat	Gain in test circuit at saturation <i>For all frequencies refer to note [3] unless noted otherwise.</i>	f = 1.0 GHz	dB	8.5	20.0	10.5
		f = 2.0 GHz			16.3	
		f = 3.0 GHz			13.4	
		f = 4.0 GHz			11.6	
		f = 5.0 GHz			10.05	
		f = 5.825 GHz ^[1]			9.5	
		f = 6.0 GHz			8.7	
Gtest_ss	Gain in test circuit at small signal <i>For all frequencies refer to note [3] unless noted otherwise.</i>	f = 1.0 GHz	dB	10.5	22.4	13.8
		f = 2.0 GHz			18.6	
		f = 3.0 GHz			15.9	
		f = 4.0 GHz			13.5	
		f = 5.0 GHz			12	
		f = 5.825 GHz ^[1]			11.5	
		f = 6.0 GHz			11.3	
Psat	Pout at 2.5 dB gain compression	f = 5.825 GHz ^[1]	dBm	21.5	22	–
Ids_sat	Drain Current at saturation	f = 5.825 GHz ^[1]	mA	80	92	115
Idss	Drain Current at small signal	f = 5.825 GHz ^[1]	mA	110	127	145
P1dB	Output Power at 1 dB compression point <i>For all frequencies refer to note [3] unless noted otherwise.</i>	f = 1.0 GHz	dBm		21.5	
		f = 2.0 GHz			21.7	
		f = 3.0 GHz			21.3	
		f = 4.0 GHz			21.8	
		f = 5.0 GHz			21.2	
		f = 5.825 GHz ^[2]			21.0	
		f = 6.0 GHz			20.6	
PAE	Power Added Efficiency at Psat ^[4] <i>For all frequencies refer to note [3] unless noted otherwise.</i>	f = 1.0 GHz	%	40	46.3	
		f = 2.0 GHz			46.0	
		f = 3.0 GHz			48	
		f = 4.0 GHz			44	
		f = 5.0 GHz			45	
		f = 5.825 GHz ^[1]			46	
		f = 6.0 GHz			47	
OIP3	Output Third Order Intercept Point [2.7 V]	f = 5.725 GHz ^[1]	dBm	31	34	–
EVM	Error Vector Magnitude Pout = 16 dBm; 54 Mbps data rate	f = 5.725 GHz ^[2]	%		5.6	
NF	Noise Figure <i>For all frequencies refer to note [3] unless noted otherwise.</i>	f = 1.0 GHz	dB		2.6	
		f = 2.0 GHz			2.7	
		f = 3.0 GHz			2.9	
		f = 4.0 GHz			3.3	
		f = 5.0 GHz			3.6	
		f = 5.825 GHz ^[2]			4.4	
		f = 6.0 GHz			5.2	

Notes:

- Measurements made on a fixed tuned production test board (figure 1), which was optimized for gain and saturated power. Excess circuit losses had been de-embedded from actual measurement. Typical data based on at least 500 parts sample size from 3 wafer lots. Future wafers allocated to this product may have nominal values anywhere within the upper and lower spec limits.
- Measurement was taken on demo board at which it was tuned for maximum gain and saturated power. Refer to application note.
- Measurement was done in a 50 Ω microstrip line, which was tuned for maximum gain and saturated power for each frequency with external double stub tuners.
- Power Added Efficiency at Psat is calculated using the following formula: $\eta_{pa} = \frac{P_{out} - P_{in}}{V_{dd} \times I_d}$

Pout = Psat in watts
Pin = Input drive power in watts
Vdd = 3.3 V
Id = Ids_sat in Ampere

MGA-545P8 Typical Performance, $T_c = 25^\circ\text{C}$, $V_d = 3.3\text{ V}$ unless stated otherwise.

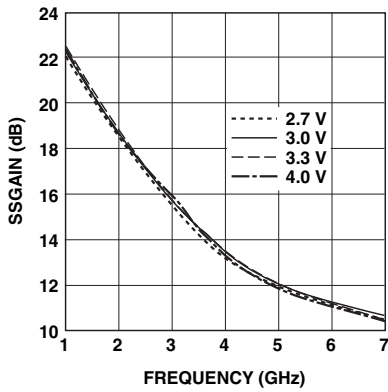

Figure 3. Small signal gain vs. frequency and voltage^[1,5].

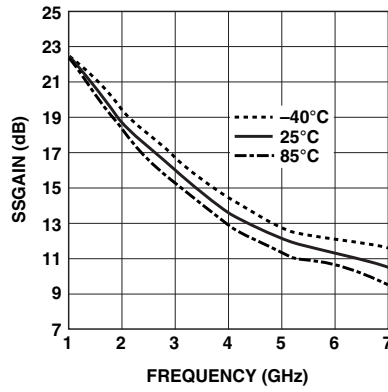

Figure 4. Small signal gain vs. frequency and temperature^[1,5].

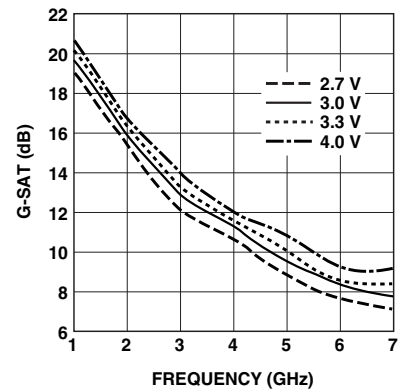

Figure 5. Saturated gain vs. frequency and voltage^[2,3,5].

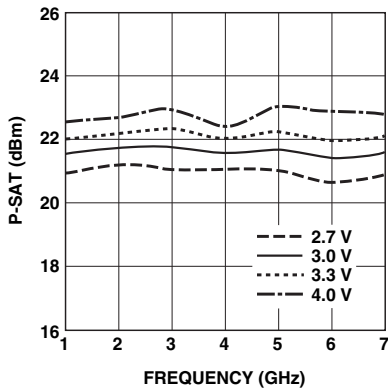

Figure 6. Saturated power vs. frequency and voltage^[2,3,5].

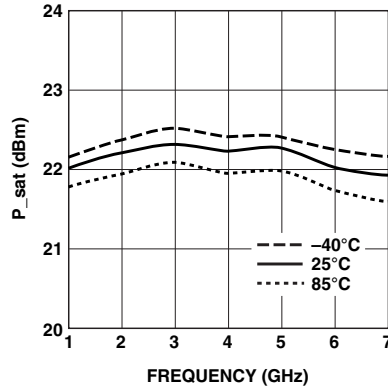

Figure 7. Saturated power vs. frequency and temperature^[2,3,5].

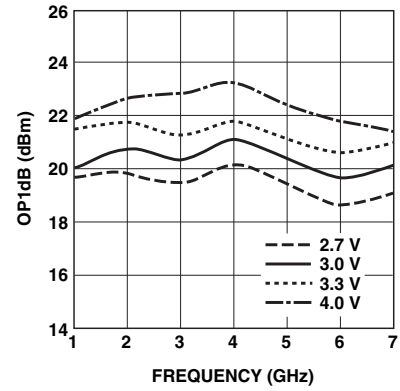

Figure 8. Output power at 1 dB gain compression vs. frequency and voltage^[2,5].

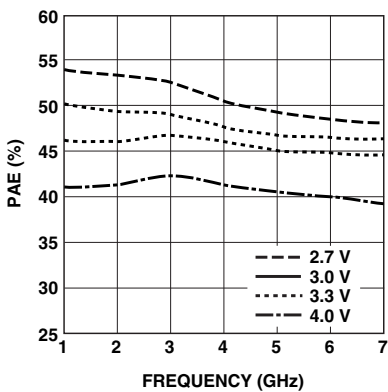

Figure 9. Power added efficiency vs. frequency and voltage^[2,3,5].

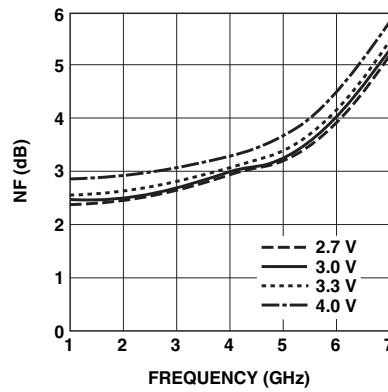

Figure 10. Noise figure vs. frequency and voltage^[2,5].

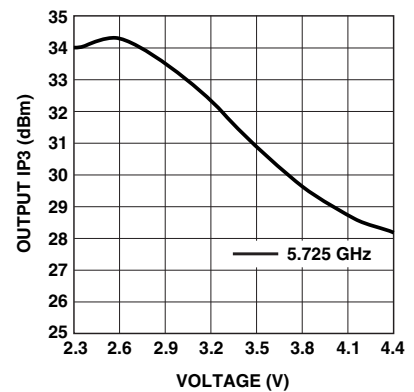

Figure 11. OIP3 vs. voltage at 5.725 GHz^[4,5].

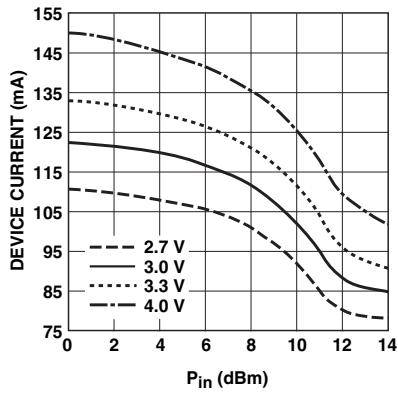

Figure 12. Device current vs. P_{in} and voltage^[4,5].

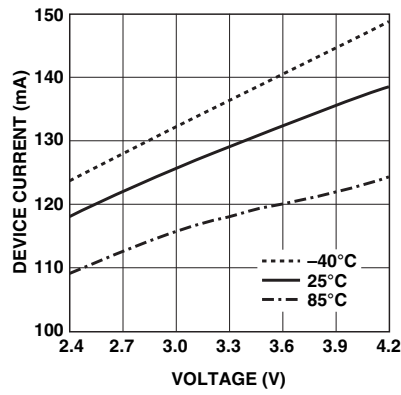

Figure 13. I_d vs. voltage and temperature (no RF drive).

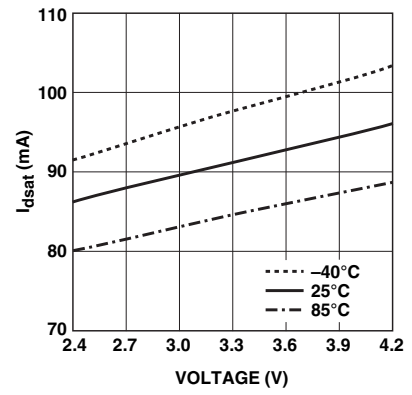

Figure 14. Saturated I_d vs. voltage and temperature^[3,4].

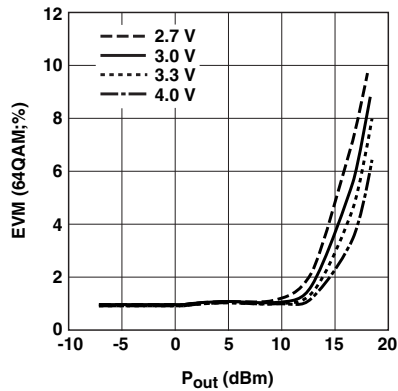

Figure 15. EVM(64QAM) vs. P_{out} and voltage at 5.725 GHz^[4].

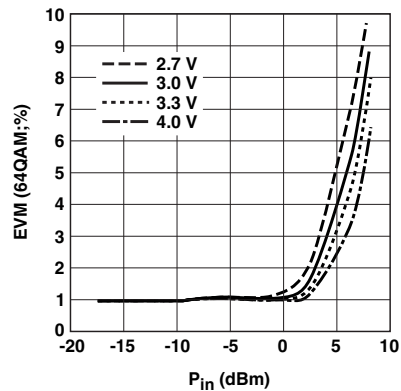

Figure 16. EVM(64QAM) vs. P_{in} and voltage at 5.725 GHz^[4].

Notes:

1. Measurement was done in a 50 Ω microstrip line with input and output tuned for maximum gain using double stub-tuners.
2. Measurement was done in a 50 Ω microstrip line with input tuned for gain and output tuned for maximum P_{sat} using double-stub tuners.
3. Measured at 2.5 dB gain compression.
4. Measurement at 5.825 GHz were made on a fixed tuned demo board that was tuned for maximum saturated output power and maximum gain.
5. Circuit losses have been de-embedded from actual measurement.

MGA-545P8 Typical Scattering Parameters

Tc = 25°C, Vd = 3.3 V, Zo = 50Ω

Freq.	S11			S21			S12		S22		K
	Mag	Ang	dB	Mag	Ang	dB	Mag	Ang	Mag	Ang	Factor
0.05	0.08	-144.5	24.4	16.57	174.5	-32.0	0.025	0.3	0.04	6.5	1.40
0.1	0.11	-140.5	24.3	16.33	169.7	-31.9	0.025	0.0	0.04	3.9	1.40
0.2	0.17	-132.4	24.0	15.85	160.1	-31.9	0.025	-0.7	0.04	-1.4	1.40
0.3	0.25	-133.4	23.7	15.34	151.5	-31.9	0.026	-0.6	0.04	-2.7	1.39
0.4	0.30	-137.1	23.3	14.65	144.1	-31.9	0.025	1.0	0.04	-4.6	1.40
0.5	0.35	-139.0	22.9	13.96	136.5	-31.8	0.026	2.4	0.06	-10.5	1.40
0.6	0.40	-144.4	22.4	13.26	131.2	-31.8	0.026	3.7	0.07	-13.2	1.38
0.7	0.44	-149.7	21.9	12.51	124.6	-31.8	0.026	4.7	0.07	-17.5	1.39
0.8	0.47	-153.9	21.4	11.80	119.2	-31.6	0.026	5.8	0.07	-22.9	1.38
0.9	0.50	-158.5	20.9	11.11	113.9	-31.6	0.026	7.2	0.07	-28.3	1.40
1.0	0.52	-162.8	20.4	10.51	109.3	-31.4	0.027	7.8	0.08	-31.7	1.40
1.5	0.59	179.0	18.2	8.09	89.5	-30.6	0.029	13.2	0.10	-48.5	1.42
1.9	0.61	166.5	16.7	6.81	78.0	-29.9	0.032	15.6	0.11	-60.5	1.45
2.0	0.62	163.8	16.2	6.47	75.8	-29.7	0.033	16.2	0.11	-67.5	1.49
2.4	0.61	153.8	14.9	5.58	65.4	-28.9	0.036	18.2	0.12	-73.8	1.56
3.0	0.62	139.3	13.5	4.71	53.0	-27.6	0.042	17.6	0.14	-74.6	1.54
4.0	0.54	116.5	11.9	3.95	28.6	-25.5	0.053	10.8	0.19	-89.2	1.63
5.0	0.38	87.9	11.4	3.70	0.5	-23.5	0.067	-6.5	0.23	-98.4	1.68
5.1	0.34	83.6	11.3	3.67	-3.4	-23.4	0.068	-9.5	0.24	-99.5	1.71
5.2	0.30	79.2	11.3	3.66	-7.2	-23.3	0.069	-12.3	0.25	-100.6	1.75
5.3	0.26	75.1	11.2	3.62	-11.1	-23.2	0.069	-16.3	0.26	-101.8	1.80
5.4	0.21	70.9	11.1	3.61	-15.5	-23.1	0.070	-18.8	0.27	-103.9	1.83
5.5	0.15	71.0	11.1	3.59	-19.6	-23.1	0.070	-22.9	0.28	-106.9	1.88
5.6	0.11	82.8	10.9	3.53	-23.0	-23.0	0.071	-25.6	0.29	-108.7	1.91
5.7	0.08	99.7	10.9	3.51	-26.0	-22.9	0.072	-27.7	0.29	-109.9	1.91
5.8	0.06	115.1	10.9	3.49	-29.2	-22.8	0.073	-30.4	0.30	-108.9	1.91
5.9	0.06	161.8	10.8	3.48	-33.2	-22.9	0.072	-33.4	0.34	-109.1	1.90
6.0	0.10	-161.5	10.8	3.46	-39.1	-23.0	0.071	-38.4	0.36	-118.8	1.91
6.5	0.43	-166.1	9.7	3.05	-71.8	-25.4	0.054	-70.7	0.47	-136.8	2.20
7.0	0.69	165.0	6.2	2.05	-104.8	-32.3	0.024	-106.7	0.50	-157.6	4.22
8.0	0.87	117.4	-3.7	0.66	-149.2	-33.2	0.022	55.7	0.46	172.0	6.38
9.0	0.91	97.6	-19.0	0.11	-172.2	-26.8	0.046	38.8	0.42	156.3	13.14
10.0	0.93	77.7	-19.3	0.11	-6.4	-23.9	0.064	18.8	0.41	143.1	8.26
11.0	0.90	63.6	-14.1	0.20	-20.6	-22.9	0.072	8.2	0.40	129.3	5.90
12.0	0.95	50.7	-12.1	0.25	-38.3	-21.8	0.081	-5.1	0.42	117.2	2.17
13.0	0.96	41.1	-12.2	0.25	-54.0	-21.4	0.085	-15.7	0.46	102.6	1.72
14.0	0.93	30.7	-12.4	0.24	-59.4	-21.1	0.088	-25.2	0.49	87.6	3.00
15.0	0.91	27.9	-13.1	0.22	-66.6	-20.6	0.093	-29.4	0.53	80.2	3.56
16.0	0.96	22.0	-12.9	0.23	-79.5	-20.4	0.096	-40.0	0.57	70.3	1.74
17.0	0.95	14.4	-13.6	0.21	-88.3	-19.8	0.103	-44.6	0.61	62.9	1.84
18.0	0.96	8.0	-13.6	0.21	-88.0	-19.1	0.111	-56.1	0.62	50.3	1.55

MGA-545P8 Typical Noise Parameters at $T_c = 25^\circ\text{C}$, $V_d = 3.3\text{ V}$

Frequency GHz	Fmin dB	Gopt		Rn/50Ω
		Mag	Ang	
1.0	2.1	0.46	-144	0.15
2.0	2.4	0.44	-133	0.20
3.0	2.5	0.44	-123	0.27
4.0	2.9	0.39	-100	0.43
5.0	3.2	0.26	-77	0.51
6.0	3.5	0.13	-77	0.48
7.0	4.4	0.38	-158	0.28

Device Models

Refer to Avago's Web Site
www.Avago.com/view/rf

Ordering Information

Part Number	No. of Devices	Container
MGA-545P8-TR1	3000	7" Reel
MGA-545P8-TR2	10000	13" Reel
MGA-545P8-BLK	100	Antistatic Bag

2x2 LPCC (JEDEC DFP_N) Package Dimensions

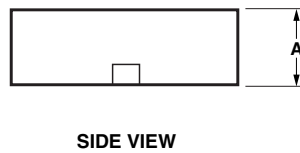
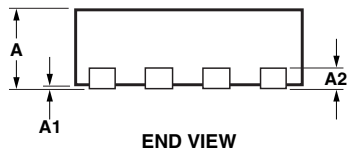
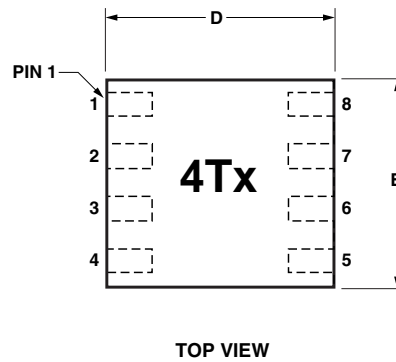
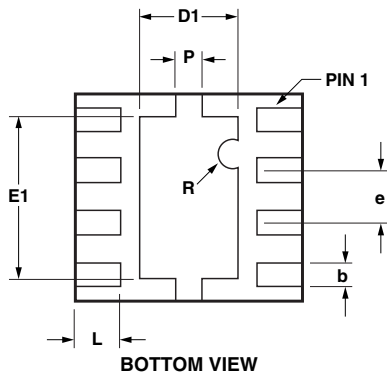

SYMBOL	DIMENSIONS		
	MIN.	NOM.	MAX.
A	0.7	0.75	0.8
A1	0	0.02	0.05
A2		0.203 REF	
b	0.225	0.25	0.275
D	1.9	2	2.1
D1	0.65	0.8	0.95
E	1.9	2	2.1
E1	1.45	1.6	1.75
e		0.50 BSC	
P	0.20	0.25	0.30
L	0.35	0.40	0.45

PCB Land Pattern and Stencil Design

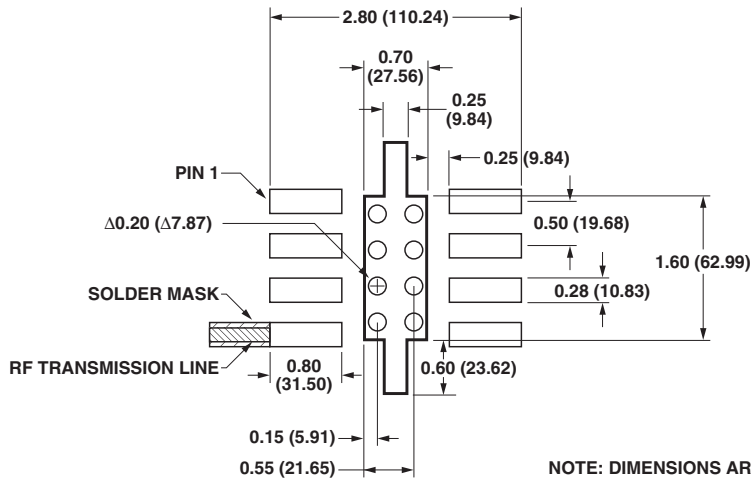

PCB LAND PATTERN (TOP VIEW)

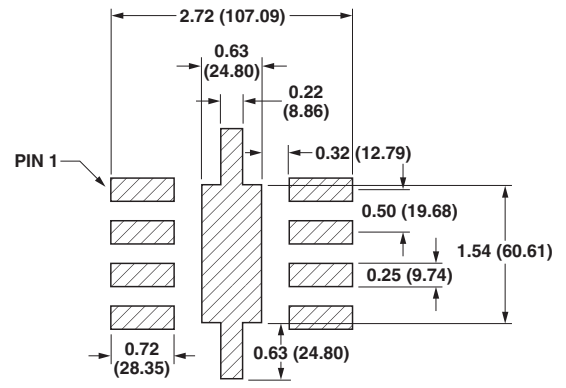

STENCIL LAYOUT (TOP VIEW)

NOTE: DIMENSIONS ARE IN MILLIMETERS

Device Orientation

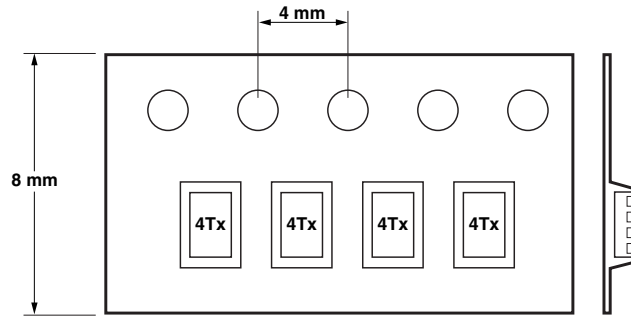
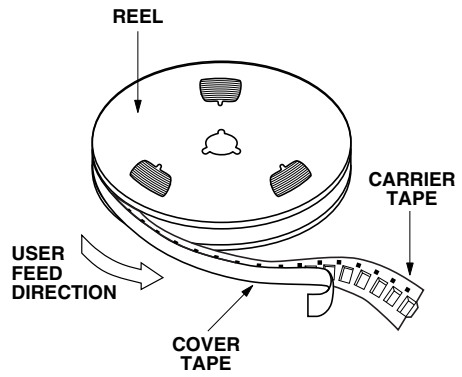

Tape Dimensions

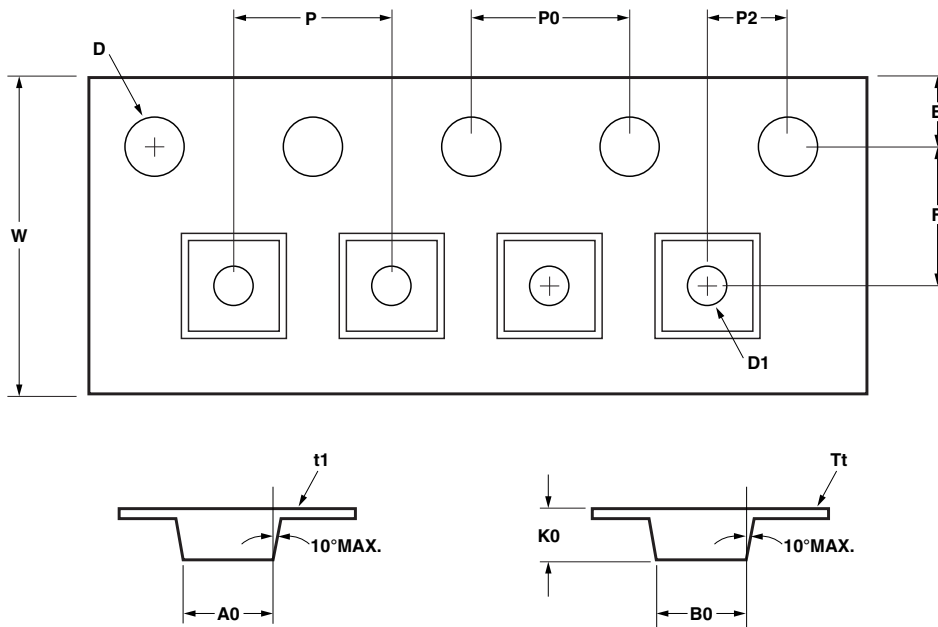

DESCRIPTION		SYMBOL	SIZE (mm)	SIZE (INCH)
CAVITY	LENGTH	A_0	2.30 ± 0.05	0.091 ± 0.004
	WIDTH	B_0	2.30 ± 0.05	0.091 ± 0.004
	DEPTH	K_0	1.00 ± 0.05	0.039 ± 0.002
	PITCH	P	4.00 ± 0.10	0.157 ± 0.004
	BOTTOM HOLE DIAMETER	D_1	1.00 ± 0.25	0.039 ± 0.002
PERFORATION	DIAMETER	D	1.50 ± 0.10	0.060 ± 0.004
	PITCH	P_0	4.00 ± 0.10	0.157 ± 0.004
	POSITION	E	1.75 ± 0.10	0.069 ± 0.004
CARRIER TAPE	WIDTH	W	$8.00 + 0.30$ $8.00 - 0.10$	0.315 ± 0.012 0.315 ± 0.004
	THICKNESS	t_1	0.254 ± 0.02	0.010 ± 0.0008
COVER TAPE	WIDTH	C	5.4 ± 0.10	0.205 ± 0.004
	TAPE THICKNESS	T_t	0.062 ± 0.001	0.0025 ± 0.0004
DISTANCE	CAVITY TO PERFORATION (WIDTH DIRECTION)	F	3.50 ± 0.05	0.138 ± 0.002
	CAVITY TO PERFORATION (LENGTH DIRECTION)	P_2	2.00 ± 0.05	0.079 ± 0.002

For product information and a complete list of distributors, please go to our web site: www.avagotech.com

Avago, Avago Technologies, and the A logo are trademarks of Avago Technologies in the United States and other countries. Data subject to change. Copyright © 2005-2012 Avago Technologies. All rights reserved. Obsoletes 5989-1810EN AV02-3623EN - June 14, 2012

AVAGO
TECHNOLOGIES

X-ON Electronics

Largest Supplier of Electrical and Electronic Components

Click to view similar products for [RF Amplifier](#) category:

Click to view products by [Broadcom](#) manufacturer:

Other Similar products are found below :

[A82-1](#) [BGA622H6820XTSA1](#) [BGA 728L7 E6327](#) [BGB719N7ESDE6327XTMA1](#) [HMC397-SX](#) [HMC405](#) [HMC561-SX](#) [HMC8120-SX](#)
[HMC8121-SX](#) [HMC-ALH382-SX](#) [HMC-ALH476-SX](#) [SE2433T-R](#) [SMA3101-TL-E](#) [SMA39](#) [A66-1](#) [A66-3](#) [A67-1](#) [A81-2](#) [LX5535LQ](#)
[LX5540LL](#) [MAAM02350](#) [HMC3653LP3BETR](#) [HMC549MS8GETR](#) [HMC-ALH435-SX](#) [SMA101](#) [SMA32](#) [SMA411](#) [SMA531](#)
[SST12LP19E-QX6E](#) [WPM0510A](#) [HMC5929LS6TR](#) [HMC5879LS7TR](#) [HMC1087F10](#) [HMC1086](#) [HMC1016](#) [SMA1212](#) [MAX2689EWS+T](#)
[MAAMSS0041TR](#) [MAAM37000-A1G](#) [LTC6430AIUF-15#PBF](#) [SMA70-2](#) [SMA4011](#) [A231](#) [HMC-AUH232](#) [LX5511LQ](#) [LX5511LQ-TR](#)
[HMC7441-SX](#) [HMC-ALH310](#) [XD1001-BD-000V](#) [A4011](#)