

PART NAME

DPS SERIES ENCLOSURE

PART No.

DPS-28709 & DPS-28709-C

REVISION DATE

2/20/21

NOTES:

- MATERIAL AND FLAMMABILITY RATING.
BODY -PC LIGHT GRAY POLYCARBONATE - UL94-5VA
COVER - PC LIGHT GRAY POLYCARBONATE - UL94-5VA
CLEAR COVER (C) - PC CLEAR POLYCARBONATE - UL94-V0 AND TESED TO PASS 5VA PER UL746C
- FOLLOW ENCLOSED INSTRUCTION FOR UL COMPLIANCE.: BOXES UL LISTED NEMA TYPE 1, 2, 3, 3R, 4, 4X, 5, 6, 6P 12, 13. DESIGNED MEETS IP65, IP66, IP67, IP68 REQUIREMENTS. UV RESISTANT FOR OUT DOOR USE.
- OPERATING TEMPERATURE IS -35 TO 110C.
- PRE INSTALLED SILICONE GASKET IN COVER
- SCREW CLOSE LID
- BOX COMES WITH 4 UNINSTALLED MOUNTING BRACKETS AND HARDWARE (DPX-100)
- OPTIONAL ACCESSORIES:
 - HINGE AND PANEL SUPPENSION KIT (DPX-444KIT)
 - 8" FLANGE KIT (2 FLANGES + 4 SCREWS) (DPX-824KIT)
 - FLOATING INTERNAL MOUNTING PANEL (DPX-287094)
 - HINGED INTERNAL MOUNTING PANEL (DPX-287092)
 - COVER MOUNTING PANEL (DPX-287093)
 - BASE INTERNAL MOUNTING PANEL (DPX-287091)
- DIMENSIONS ARE INCH

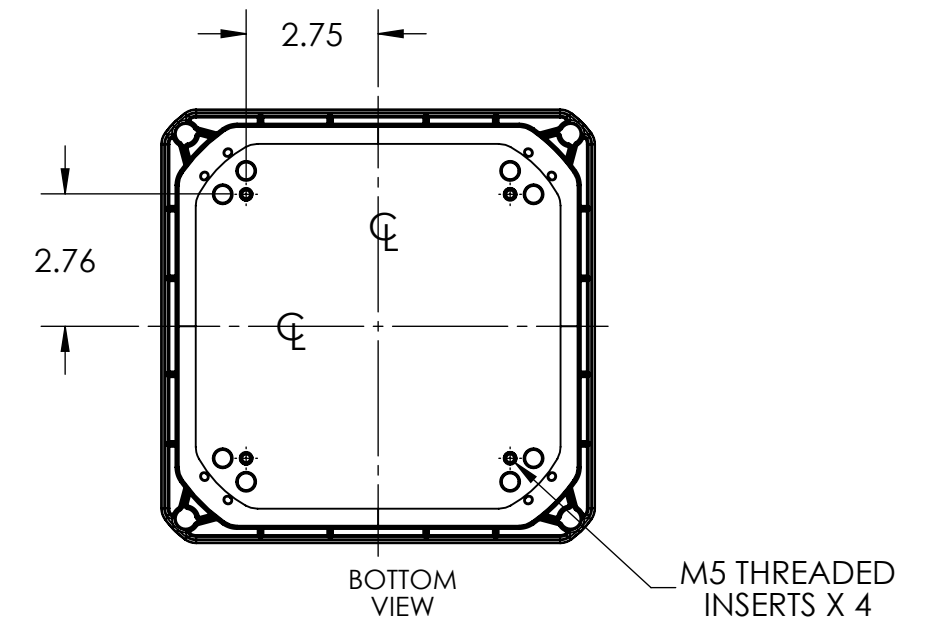
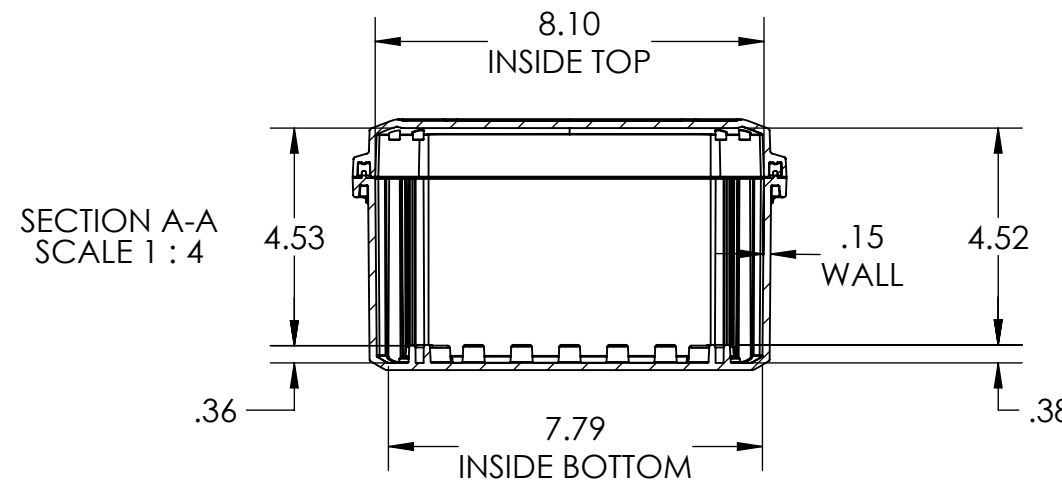
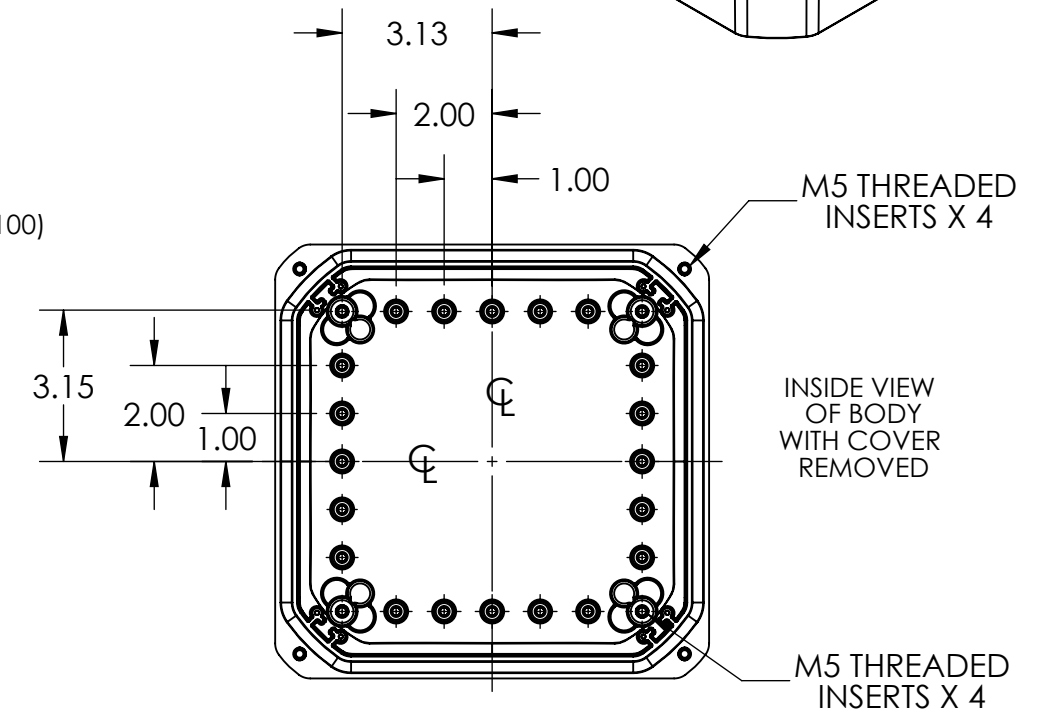
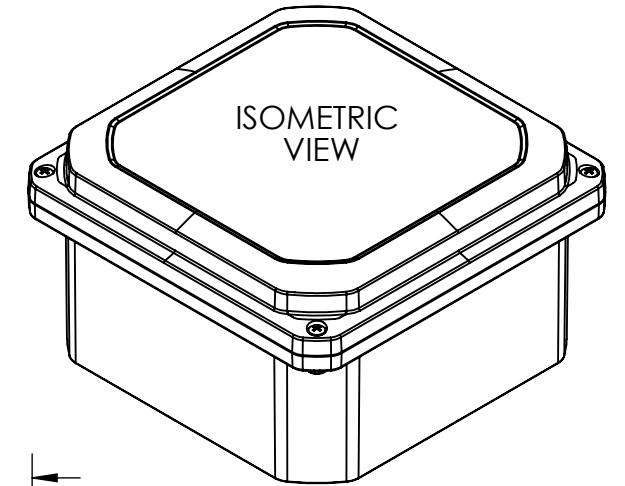
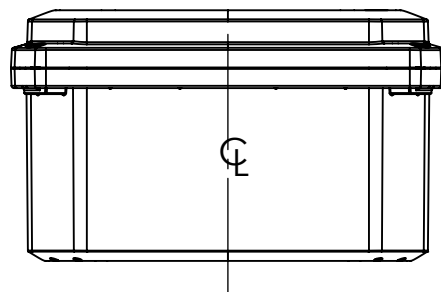
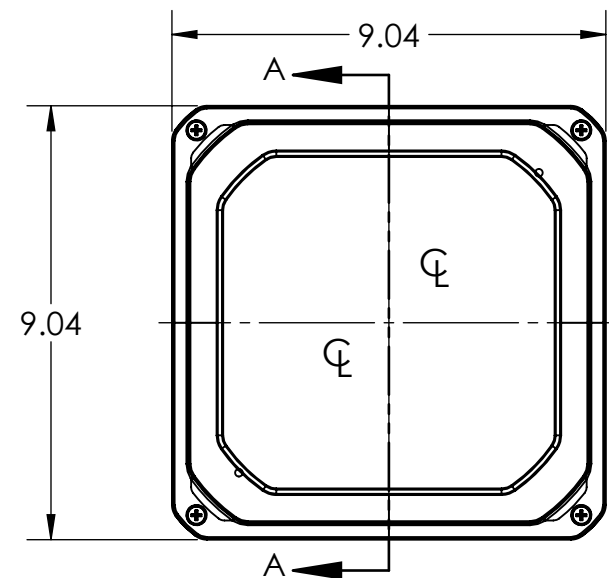
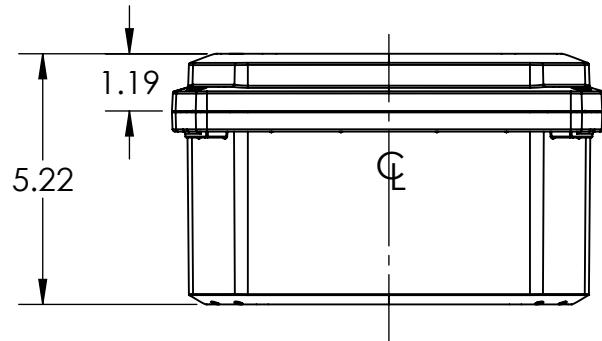

DRAWING FOR REFERENCE

WE RESERVE THE RIGHT TO MAKE CHANGES TO OUR STANDARD PRODUCTS. PLEASE CONSULT WITH BUD INDUSTRIES PRIOR TO USING THIS DRAWING FOR DESIGN PURPOSE.

X-ON Electronics

Largest Supplier of Electrical and Electronic Components

Click to view similar products for [Enclosures for Industrial Automation](#) *category:*

Click to view products by [Bud Industries](#) *manufacturer:*

Other Similar products are found below :

[116-508](#) [130-008](#) [190-005](#) [2202307](#) [2901699](#) [2790318](#) [WM011RI,BK](#) [WM052I,GY](#) [WM093RI,BK](#) [5030266](#) [WM053R,BK](#) [WM032I,BK](#)
[2909989](#) [120-908](#) [150-007](#) [790-207](#) [2200095](#) [111-012](#) [127-408](#) [802-407](#) [115-401](#) [795-001](#) [790-211](#) [733-820](#) [BW67DBKCSYL](#)
[CX68DBKANG](#) [CXL68DBKAYL](#) [CXL65DBKANG](#) [BW68DBKCSBL](#) [DPH-28714-C](#) [135-007](#) [721-032](#) [1103440](#) [1037322](#) [1167159](#)
[1158978](#) [1158981](#) [1158982](#) [2202667](#) [1017444](#) [BWA-AH664](#) [100-403-91](#) [100-405-01](#) [101-003-91](#) [101-004-91](#) [101-506-01](#) [WM012I,GY](#)
[WM013I,AL](#) [WM052RI,GY](#) [WM093RI,GY](#)