

PART NAME

JUNCTION BOX w/ HINGED COVER & KNOCKOUTS

PART No.

JBH-4954-KO

REVISION DATE

7-18-11

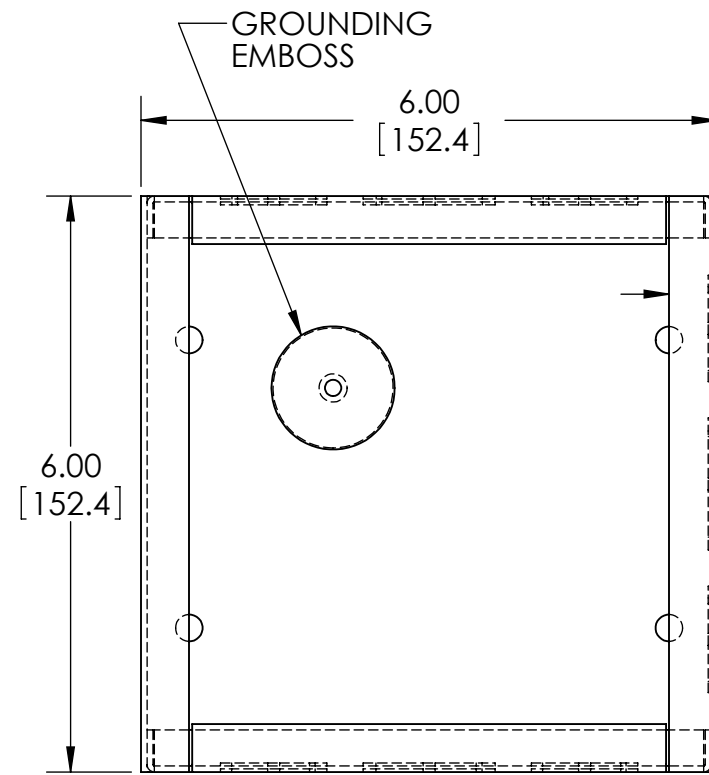
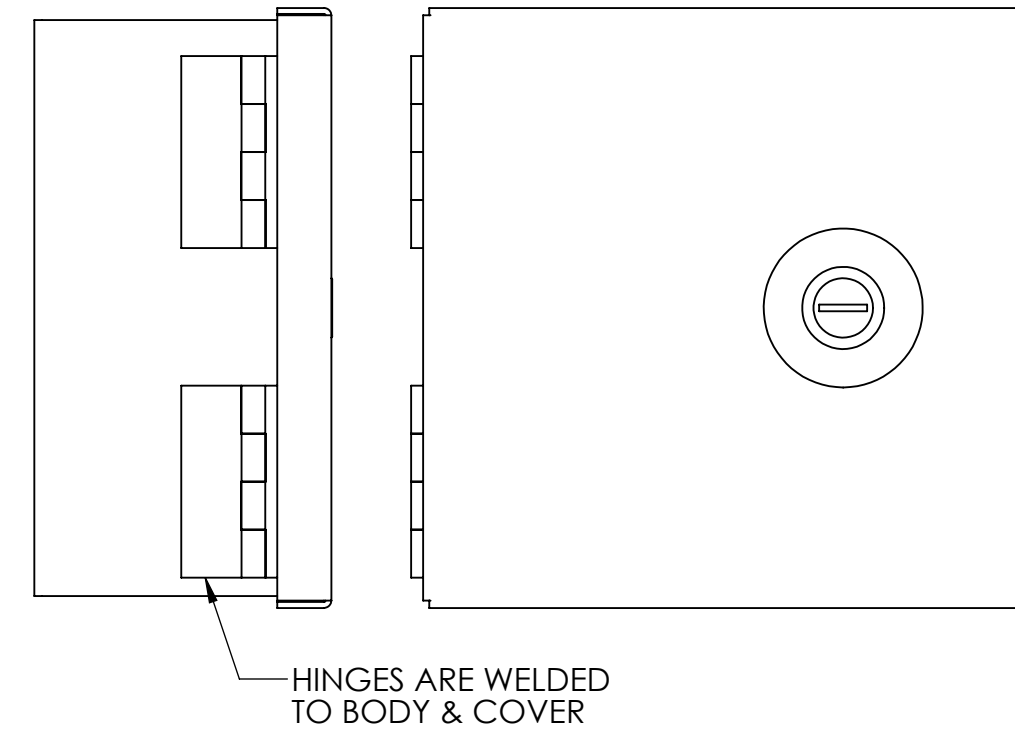
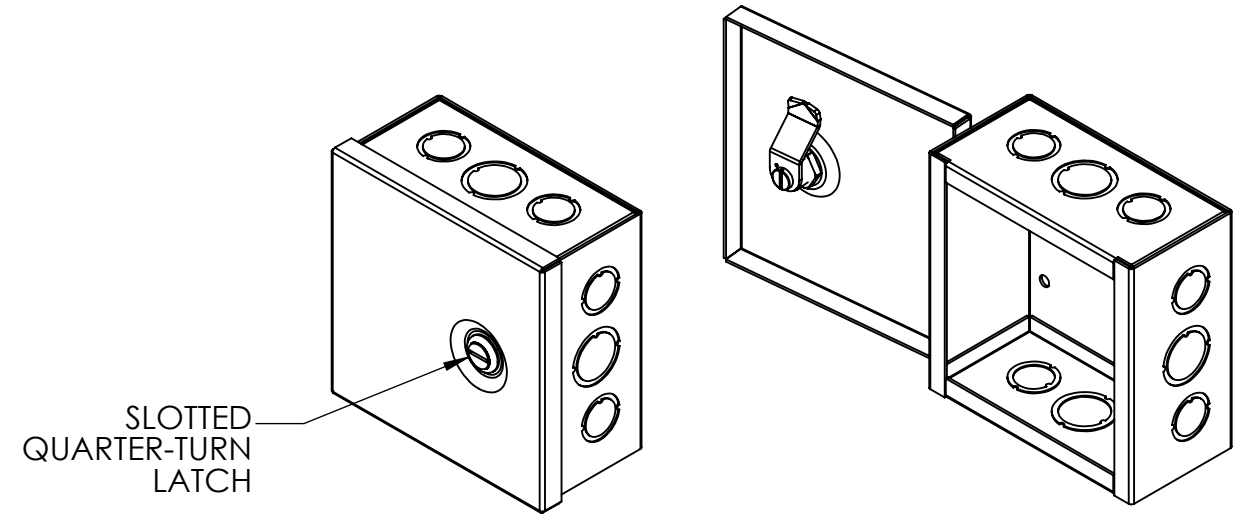
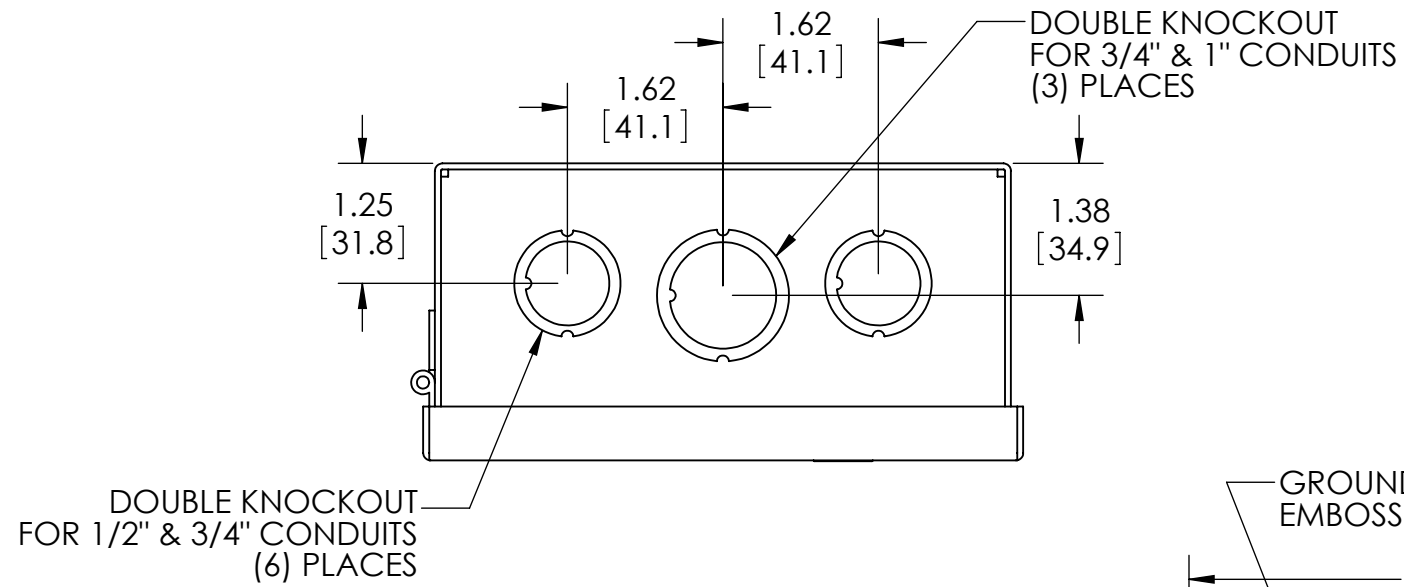

COVER NOT SHOWN THIS VIEW

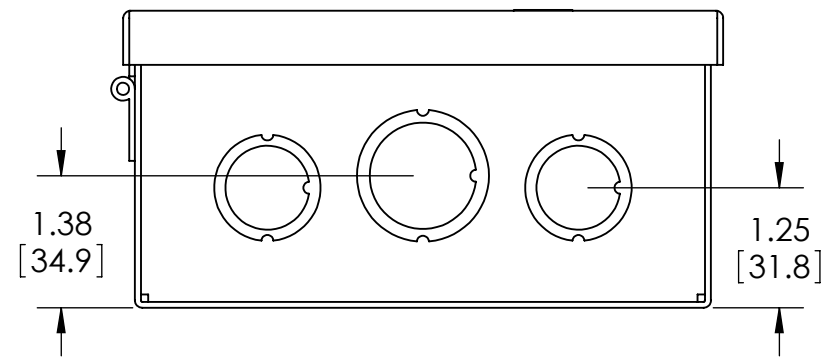
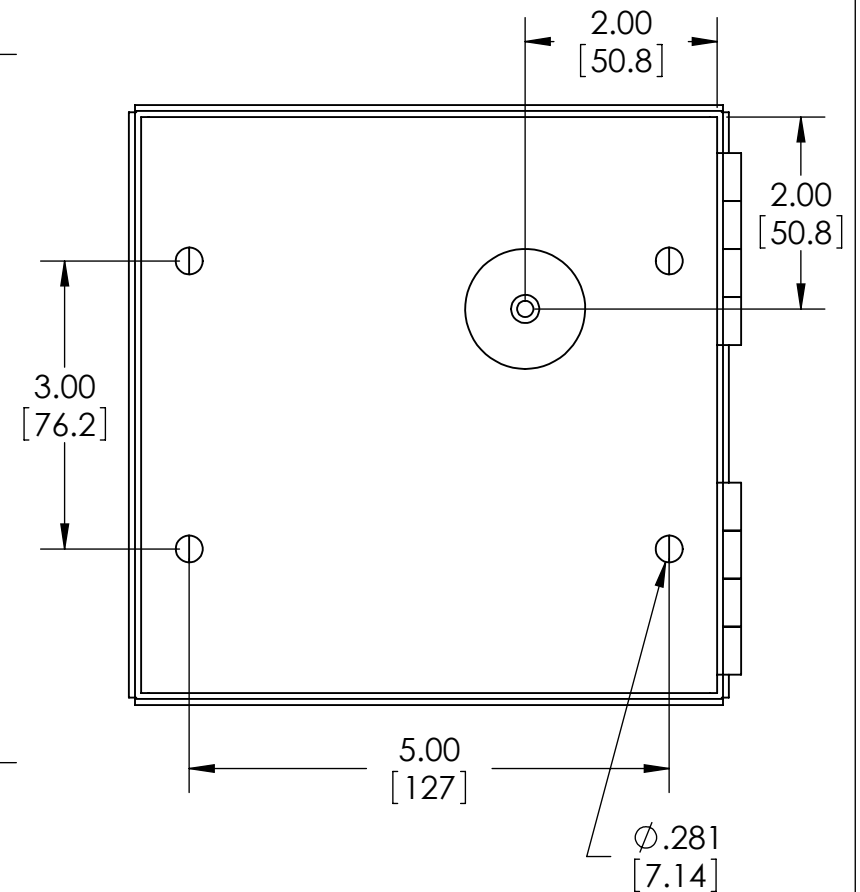
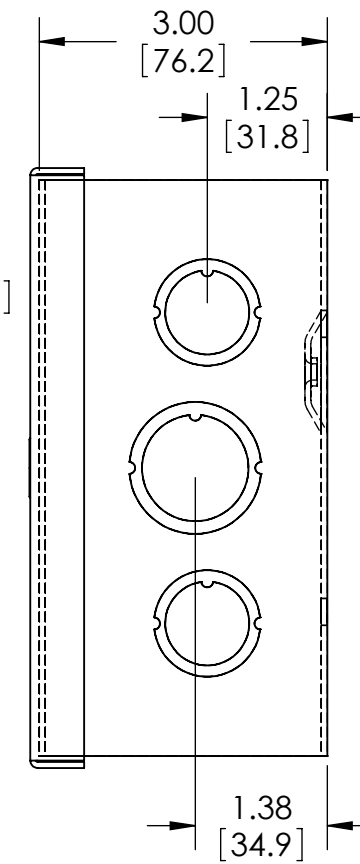

MATERIAL - 16 GA. [1.5mm] STEEL

FINISH - SMOOTH GRAY POWDERCOAT

INCLUDES ONE (1) #10-32 x .31"[8mm] LG. MACHINE, PAN HEAD, SLOTTED/SQUARE COMBINATION STYLE DRIVE, STEEL, ZINC PLATED SCREW FOR GROUND POINT.

X-ON Electronics

Largest Supplier of Electrical and Electronic Components

Click to view similar products for [Electrical Enclosures](#) category:

Click to view products by [Bud Industries](#) manufacturer:

Other Similar products are found below :

[MR-25L+](#) [1584DMGPK](#) [30-8739](#) [PIP-11774SCREW](#) [30-9715](#) [30-9777-BU](#) [110-402](#) [A242012LP](#) [A16N12BLP](#) [111-005](#) [9511096](#) [9511016](#)
[9822011](#) [CAB PC 203018 G](#) [NSYTLEU](#) [PC 30/25-FC3](#) [9820006](#) [1010.600](#) [1012.600](#) [AR242410CHSSL](#) [120-404](#) [127-406](#) [127-906](#)
[79021101](#) [EKIV 17](#) [EKIV 37](#) [18200101](#) [18600801](#) [19501001](#) [19600901](#) [TRH 24](#) [A317SEAL](#) [A3735SEAL](#) [HV 60 MW](#) [X16C LGR-TR](#)
[X25C LGR-TR](#) [T 160 OE HD LGR](#) [T 350 OE HD LGR](#) [T 60 M20](#) [T 60 M20 NL](#) [SDB 03 PS](#) [SDB 09 PS](#) [P2018SEAL](#) [EN1309N4](#)
[EN1511N4LATCH](#) [GSV171](#) [2762-00](#) [2763-00](#) [2765-00](#) [2761-00](#)