

PART NAME	NEMA 4X ENCLOSURE	PART No.	PNR-2605, PNR-2605-C AND PNR-2605-DG PNR-2606, PNR-2606-C AND PNR-2606-DG	REV. DATE	11-17-08
-----------	-------------------	----------	--	-----------	----------

INDUSTRY STANDARDS:
 POLYCARBONATE (LIGHT GRAY AND CLEAR)
 UL94-HB FLAMMABILITY RATING (UL FILE #E41613)
 UV STABILIZED
 SERVICE TEMPERATURE RANGE: -40°C TO +120°C
 ABS (DARK GRAY)
 UL94-HB FLAMMABILITY RATING (UL FILE #E56070)
 SERVICE TEMPERATURE RANGE: -40°C TO +80°C

PART NUMBER	DIMENSION			
	A	B	C	D
PNR-2605, PNR-2605-C AND PNR-2605-DG	1.442	1.382	2.377	1.926
PNR-2606, PNR-2606-C AND PNR-2606-DG	3.022	2.962	3.957	3.506

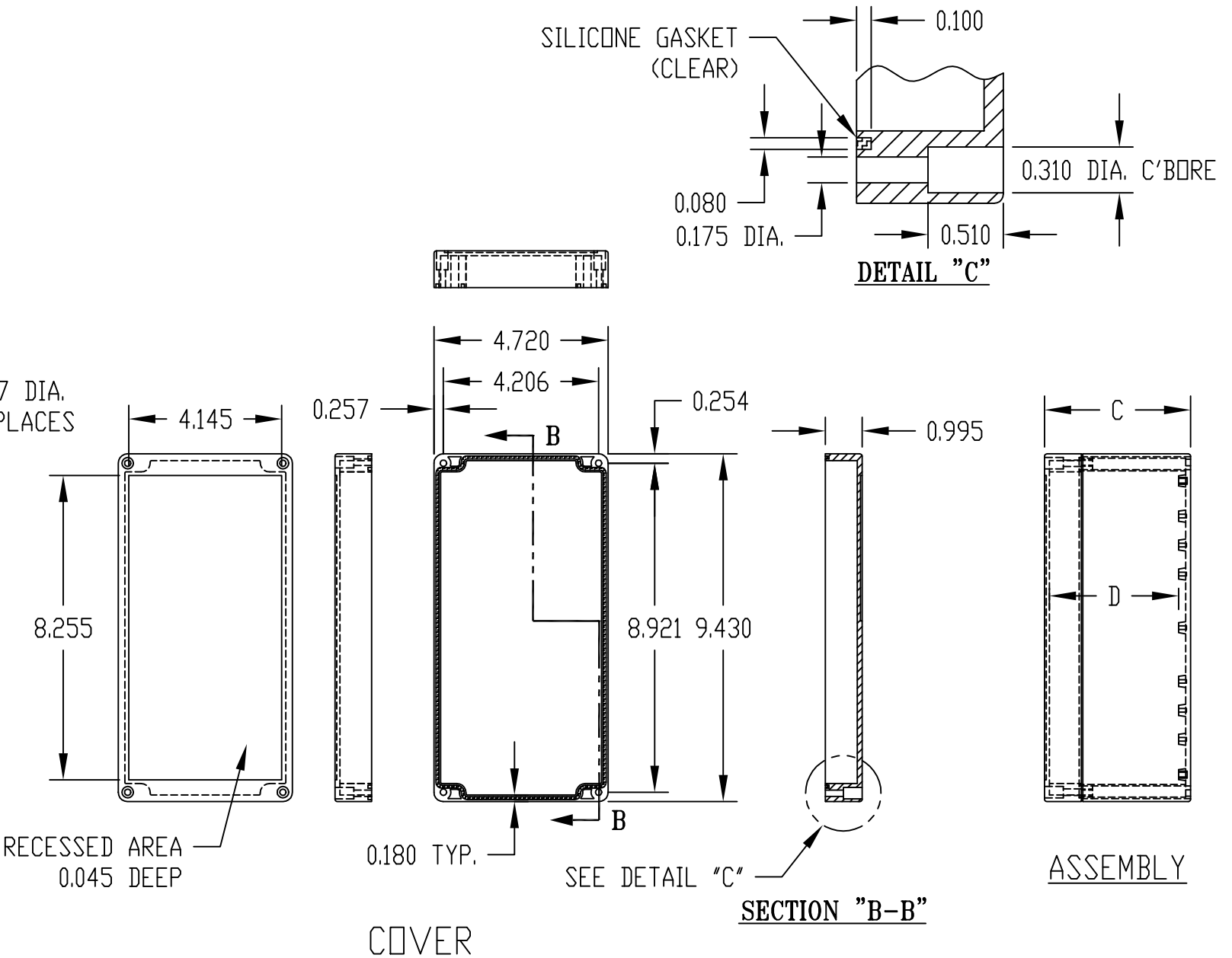
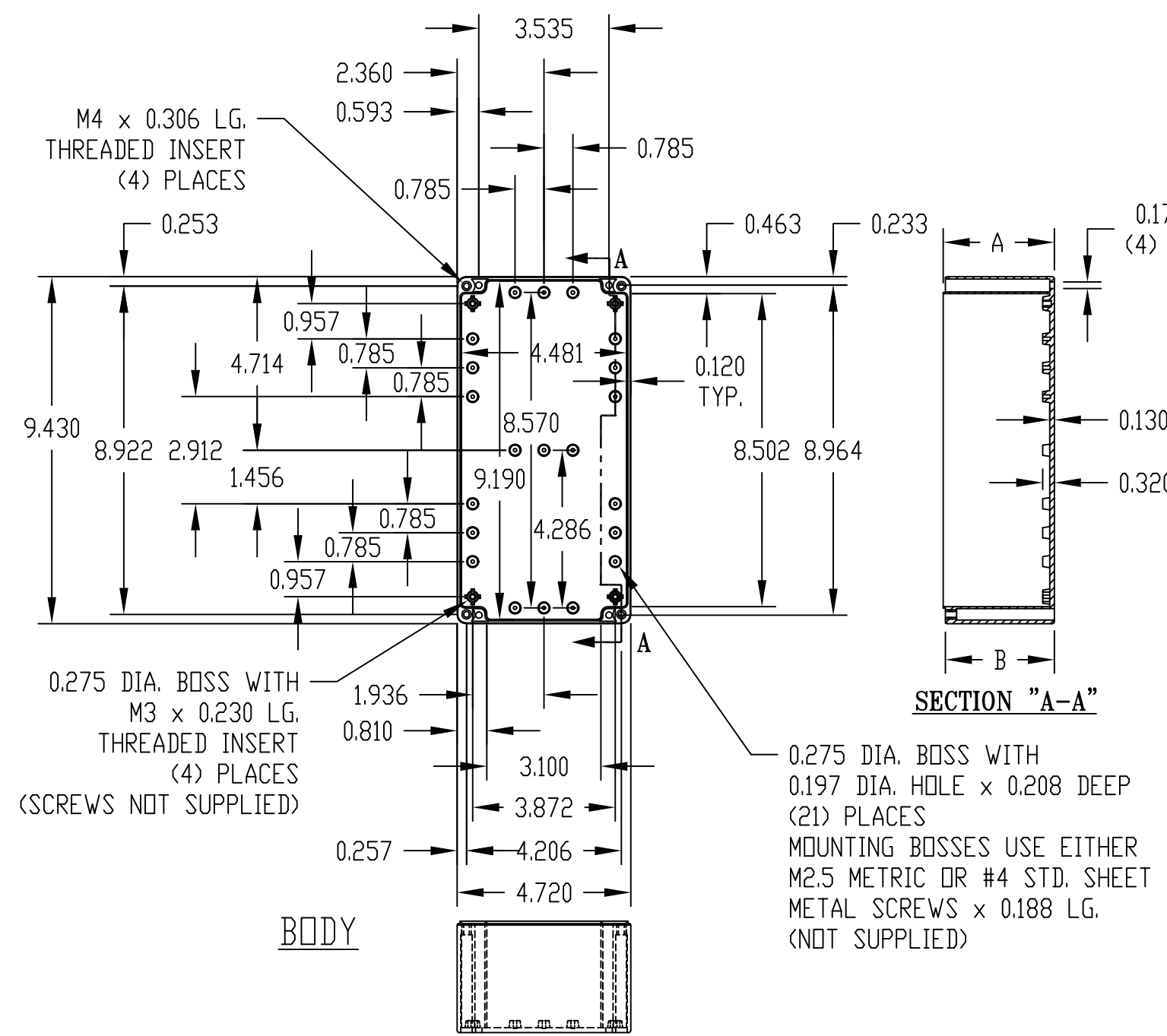

NOTE: ALL DIMENSIONS HAVE ±0.015 TOLERANCE UNLESS OTHERWISE SPECIFIED.

PART NUMBER	MATERIAL		FINISH		HARDWARE KIT
	BODY	COVER	BODY	COVER	
PNR-2605 & PNR-2606	POLYCARBONATE		LIGHT GRAY		KIT CONTAINS (4) M4 x 17mm (0.668") LG. SCREWS FOR ASSEMBLY
PNR-2605-C & PNR-2606-C	POLYCARBONATE		LIGHT GRAY	CLEAR	
PNR-2605-DG & PNR-2606-DG	HIGH-IMPACT ABS		DARK GRAY		

X-ON Electronics

Largest Supplier of Electrical and Electronic Components

Click to view similar products for [Electrical Enclosures](#) category:

Click to view products by [Bud Industries](#) manufacturer:

Other Similar products are found below :

[120-401](#) [120-905](#) [120-909](#) [120-403](#) [130-004](#) [MR-25L+](#) [30-8739](#) [PIP-11774SCREW](#) [30-9715](#) [30-9777-BU](#) [105-905](#) [110-902](#) [110-901](#)
[A16N12BLP](#) [110-406](#) [110-401](#) [110-404](#) [120-405](#) [34861601](#) [106-009](#) [106-505](#) [105-405](#) [111-005](#) [127-909](#) [106-502](#) [130-503](#) [127-455](#)
[9511150](#) [9511017](#) [9820011](#) [NSYTDB5PL](#) [137-455](#) [130-001](#) [105-904](#) [120-404](#) [137-005](#) [130-505](#) [127-406](#) [AB 1,5.0](#) [AB2.0](#) [ABM.0](#)
[73345601](#) [F-MP](#) [H-MP](#) [M-MP](#) [PAT 12040](#) [2461000](#) [9121230](#) [79541301](#) [19001001](#)