

# 2000 Slide Switches - Snap fit and panel mount 10A 250Vac

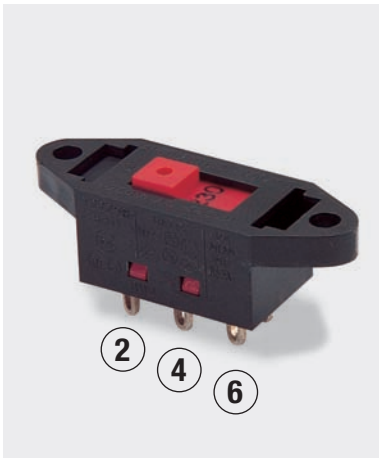

- ▶ 2 way 'voltage selector'
- ▶ Ratings up to 16A, 250V ac
- ▶ Snap fit and panel mount
- ▶ PCB & solder terminals
- ▶ 2 and 3 position
- ▶ Choice of circuits
- ▶ Choice of actuators



10 A 250Vac T85  
6(3)A 250Vac T85



UL CSA 16A 250Vac Non Inductive  
UL CSA 4A 300Vac  
UL 65°C, file no. E45221, CSA file no. LR10990



RoHS compliant

μ contact gap

Please specify: Standard action (SP116) or light action (SP118).  
2000 series lubrication is inorganic and does not degrade plastics.

Technical data on pages 4 & 5.

115/230 is preferred legend

**B** BLACK  
**W** WHITE  
**R** RED

**T 2 2 20 5 B R 436B**

## ORDER FORMAT

TERMINAL CODE    SERIES CODE    POSITIONS CODE    CIRCUIT CODE    SLIDER CODE    BODY CODE    SLIDER COLOR    LEGEND/COLOR & OPTIONS

TERMINAL	SERIES	POS'N	CIRCUIT	SLIDER				
<p><b>K</b></p> <p>2.8 x 0.8</p>	2	2	<p>10</p> <p>20</p> <p>30</p> <p>40</p>	<p><b>0</b></p> <p>2 Pos B Body only</p>	<p><b>6</b></p> <p>2 &amp; 3 Pos B Body only</p>	<p><b>C</b></p> <p>2 &amp; 3 Pos B Body only</p>	<p><b>L</b></p> <p>2 &amp; 3 Pos B Body only Limited travel on 2 pos</p>	<p><b>S</b></p> <p>Limited travel on 2 pos 2 &amp; 3 Pos B Body only</p>
<p><b>R</b></p> <p>2.8 x 0.8</p>				<p><b>2</b></p> <p>2 Pos B Body only</p>	<p><b>7</b></p> <p>2 &amp; 3 Pos B Body only</p>	<p><b>D</b></p> <p>2 &amp; 3 Pos B Body only</p>	<p><b>M</b></p> <p>F Body only Legend optional</p>	<p><b>T</b></p> <p>2 &amp; 3 Pos B Body only</p>
<p><b>T</b></p> <p>Solder</p>				<p><b>3</b></p> <p>2 &amp; 3 Pos B Body only</p>	<p><b>8</b></p> <p>E Body only Legend optional</p>	<p><b>E</b></p> <p>2 Pos B Body only Limited travel on 2 pos</p>	<p><b>N</b></p> <p>2 Pos B Body only</p>	
<p><b>X</b></p> <p>PCB 0.8 Sq. For mounting stability switches have extra "support" terminals</p> <p>* Nominal - Dimension varies with body type. For exact figure call sales</p>				<p><b>4</b></p> <p>2 &amp; 3 Pos B Body only</p>	<p><b>9</b></p> <p>2 &amp; 3 Pos B Body only</p>	<p><b>H</b></p> <p>2 Pos B Body only</p>	<p><b>P</b></p> <p>2 &amp; 3 Pos B Body only Limited travel on 2 pos</p>	
				<p><b>5</b></p> <p>2 Pos B Body only Also with legend</p>	<p><b>A</b></p> <p>2 Pos B Body only</p>	<p><b>K</b></p> <p>2 &amp; 3 Pos B Body only Limited travel on 2 pos</p>	<p><b>R</b></p> <p>2 &amp; 3 Pos B Body only</p>	
				<p><b>10</b></p> <p>20</p> <p>30</p> <p>40</p>				



T22208E ---



T22308E ---



T2230MF ---



T22205B ---



T22305B ---



T23204B ---

**BODY**

**B With mounting holes**

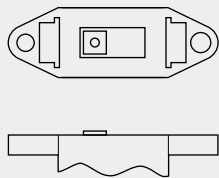

**E Snap fit**

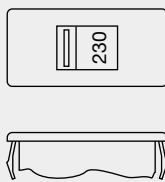

Cut-outs must be punched in the direction of insertion

**F Snap fit (single pole ON OFF only)**

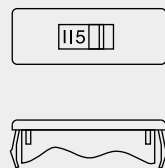

Cut-outs must be punched in the direction of insertion

**OPTIONS**

**Color**  
For custom slider colors call the factory. A full range is available for large orders

Standard body color is black

**Legend printing**

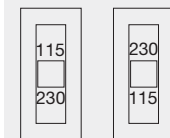

**436( ) 437( )**

( ) is legend color  
(B) - Black  
(W) - White  
(R) - Red

Please call the sales for custom legends

**DIMENSIONS (mm)**

**2 Pos B**

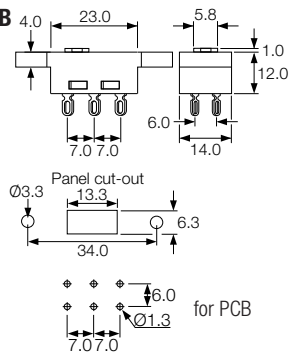

**Cut-out / PCB Matrix**

**3 Pos B**

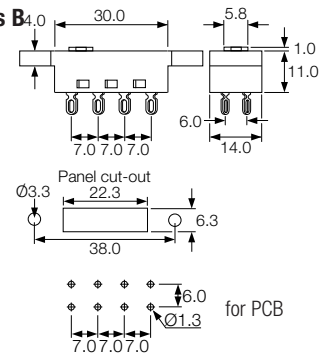

**2 Pos E**

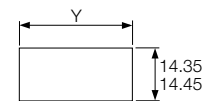
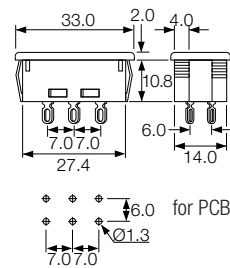

Panel thickness	Dim. Y
0.8-1.2	29.75/29.85
1.63	30.15/30.25
2.0	30.35/30.45
2.5	30.55/30.65

**2 Pos F**

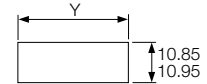
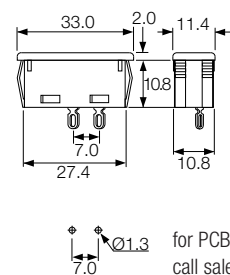

Panel thickness	Dim. Y
0.8-1.2	29.75/29.85
1.63	30.15/30.25
2.0	30.35/30.45
2.5	30.55/30.65

for PCB, call sales for details

slide switches

## X-ON Electronics

Largest Supplier of Electrical and Electronic Components

*Click to view similar products for [Slide Switches](#) category:*

*Click to view products by [Bulgin](#) manufacturer:*

Other Similar products are found below :

[6-1437581-1](#) [M43R](#) [MHS123K15D](#) [MHS133K](#) [MMD](#) [MSS12A](#) [1825160-3](#) [1825167-2](#) [K232CB](#) [25139NLDB](#) [25449NAH](#) [1825078-1](#)  
[1825080-4](#) [1825269-1](#) [1825270-2](#) [STS141RA04](#) [T2215BEN506](#) [GH46P000001](#) [GH49P010001](#) [25339NA](#) [M42A](#) [AYZ0202AG](#)  
[L203091MS02Q](#) [4-1437581-7](#) [X2225CR-437W](#) [48BFSP3M2QT](#) [1101M1S3ZB8E2](#) [1-1437581-1](#) [EG1218REDACTUATOR](#) [TG39W000000](#)  
[MSS42G](#) [T105S1CWZBE](#) [SLB124145](#) [SLB1280R5](#) [SLB1340R45](#) [25136NLDB](#) [TG39W000050](#) [25149NAH](#) [25439NAH](#) [TG36Y000050](#)  
[GE36P000001](#) [SL-1211C1B8](#) [46204LRX](#) [C56206L1X](#) [1977143-4](#) [1977144-4](#) [1977145-4](#) [HASS0194](#) [JS0001](#) [25149NAB](#)