

A		B		C		D		E	
REV.	DESCRIPTION					ECN NO.	NAME	DATE	

1

2

3

4

5

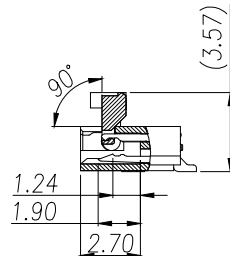
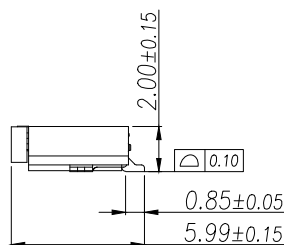
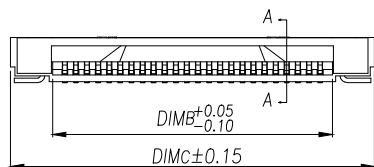
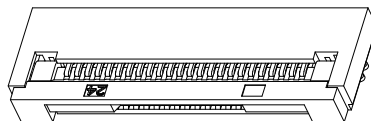
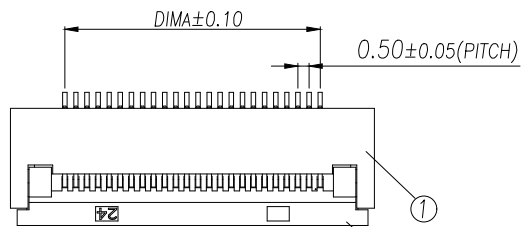

SECTION A-A

Part No	Pin	A	B	C
FC-05A4P11H20	4	1.50	2.60	6.40
FC-05A5P11H20	5	2.00	3.10	6.90
FC-05A6P11H20	6	2.50	3.60	7.40
FC-05A7P11H20	7	3.00	4.10	7.90
FC-05A8P11H20	8	3.50	4.60	8.40
FC-05A9P11H20	9	4.00	5.10	8.90
FC-05A10P11H20	10	4.50	5.60	9.40
FC-05A11P11H20	11	5.00	6.10	9.90
FC-05A12P11H20	12	5.50	6.60	10.40
.....
FC-05A65P11H20	65	(60-1)*0.5	(60+1)*0.5+0.10	(60+9)*0.5-0.1

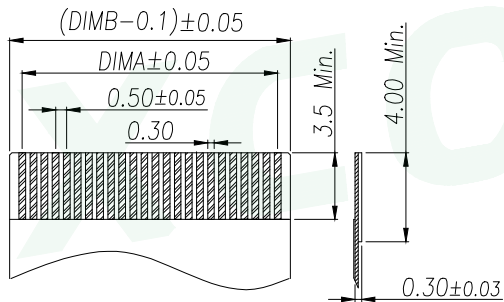
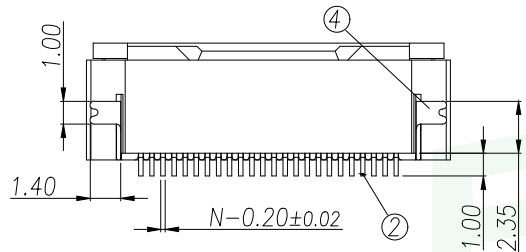

适用扁平线(Applicable Flat Cable)

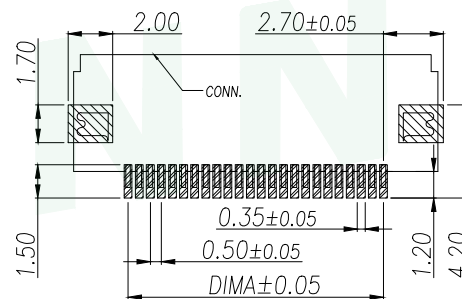

适用线路板(PCB LAYOUT)

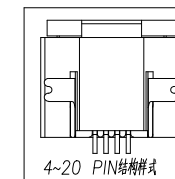

序号	品名	材质
1	0.5mm超薄板(H=2.0)	LCP UL94V-0 本色
2	0.5mm超薄端子(H=2.0)	铜合金/表面镀锡
3	0.5mm超薄后盖(H=2.0)	LCP UL94V-0 黑色
4	0.5mm超薄焊片(H=2.0)	铜合金/表面镀锡

技术指标:

1. 塑件表面应光洁, 无毛边, 无明显收缩、缺陷、裂纹等现象.
2. 温度范围: -25°C~+85°C.
3. 额定电压: 50V, AC/DC.
4. 接触电阻: ≤0.03Ω.
5. 绝缘电阻: ≥500MΩ

GENERAL TOLERANCE		DONGGUAN BAOXUN PRECISION TECHNOLOGY CO., LTD			
DIM.	TOL.	TITLE: 0.5 Pitch H2.0 Easy-on R/A Down Type CONN			
X		DWG. NO.: FC-05ANP11H20		DRAWN: MAX	
X.X	±0.30	PART NO.: FC-05ANP11H20		CHECKED: ELLA	
X.XX	±0.25	APPROVED: WILL			
X.XXX	±0.15	UNIT: mm	SCALE: none	SHEET: 1 of 1	DWG. SIZE: A4
GENERAL ANGLE:	±3°	LAYER: bxconn			

BXCONN®



A	B	C	D	E
---	---	---	---	---

REV.	DESCRIPTION	ECN NO.	NAME	DATE

1

2

3

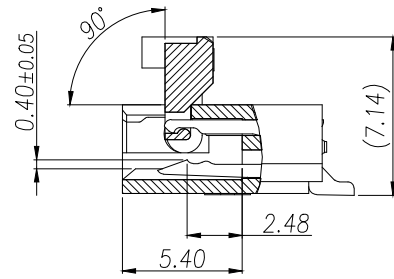

4

5

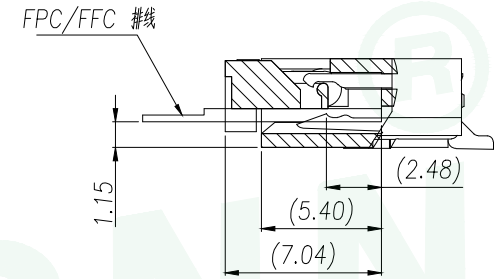

SECTION A-A
SCALE 2:1

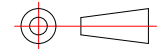

GENERAL TOLERANCE		DONGGUAN BAOXUN PRECISION TECHNOLOGY CO., LTD				 
DIM.	TOL.	TITLE: 0.5 Pitch H2.0 Easy-on R/A Down Type CONN				
X		DWG. NO.: FC-05ANP11H20		DRAWN: MAX		
X.X	±0.30	PART NO.: FC-05ANP11H20		CHECKED: ELLA		
X.XX	±0.25	UNIT: mm		APPROVED: WILL		
X.XXX	±0.15	SCALE: none	SHEET: 1 of 1	DWG. SIZE: A4	LAYER: bxconn	
GENERAL	ANGLE: ±3°					

X-ON Electronics

Largest Supplier of Electrical and Electronic Components

Click to view similar products for [FFC & FPC Connectors](#) category:

Click to view products by [BXCONN](#) manufacturer:

Other Similar products are found below :

[00-6200-227-022-800](#) [006205250500825+](#) [006205280500825+](#) [FPH-1602G](#) [086222026001800](#) [52610-0675](#) [62674-201121DLF](#) [52746-1671-TR250](#) [10051922-1610EHLF](#) [10051922-2810EHLF](#) [686322124422](#) [XF3M-2915-1B-R100](#) [AYF353125A](#) [AYF530665TA](#) [AYF534065TA](#) [20FLH-RSM1-TB](#) [PCA-7F-25-HL-3-G](#) [207356-1](#) [52807-0430](#) [FFC05011-10SBB114W5M](#) [502250-8027](#) [FH28K-40S-0.5SH](#) [200528-0260](#) [FH28K-10S-0.5SH](#) [501951-1250](#) [X05B20U43T](#) [0.5K-DX-30PWB](#) [DS1020-08-10VBT12](#) [THD0515-34CL-GF](#) [X05A10L28G](#) [ECC2841061EU](#) [1.0K-DHGX-16PWB](#) [1.0K-DHGX-30PWB](#) [1775333-6](#) [10054365-202110ELF](#) [10054365-242110ELF](#) [10054365-282110ELF](#) [10064555-392220HLF](#) [59453-041110EBHLF](#) [59453-091110EDHLF](#) [62674-241141ALF](#) [62684-432100ALF](#) [62684-451100AHLF](#) [62684-5721N0ALF](#) [HFW11R-1STE1MTLF](#) [HFW12R-1STE9LF](#) [HFW14R-1STE9MTLF](#) [HFW18S-2STE9LF](#) [HFW20R-1STAE1HLF](#) [HFW20R-1STE1MTLF](#)