

REV.	DESCRIPTION	ECN NO.	NAME	DATE

1

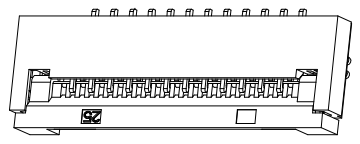

2

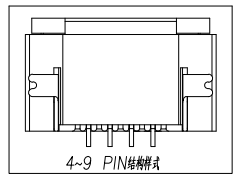
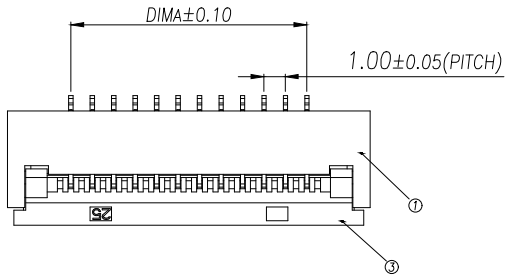
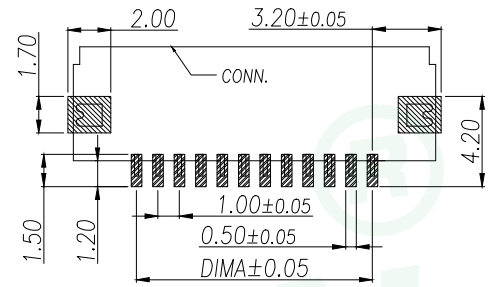
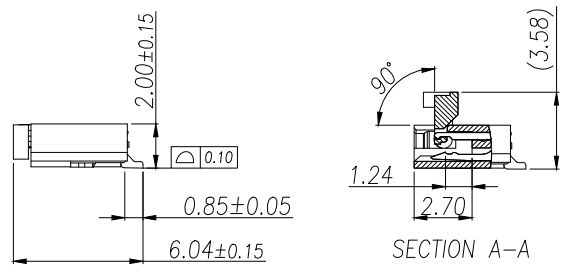
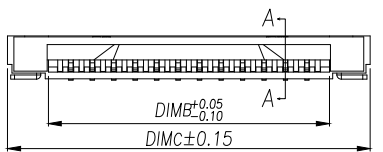

3

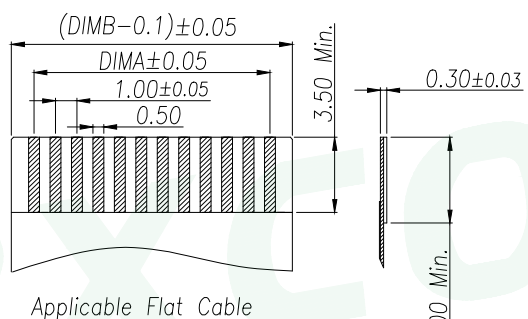
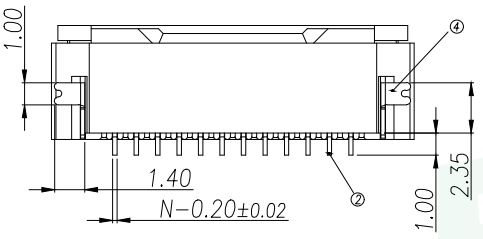

适用线路板(PCB LAYOUT)

4

序号	品名	材质
1	0.5mm间距(±12.0)	LCP UL94V-0 阻燃
2	0.5mm间距(±12.0)	铜合金/表面镀锡
3	0.5mm间距(±12.0)	LCP UL94V-0 阻燃
4	0.5mm间距(±12.0)	铜合金/表面镀锡

技术指标:

1. 塑件表面应光洁、无毛边、无明显收缩、缺陷、裂纹等现象。
2. 温度范围: -25°C~85°C.
3. 额定电压: 50V, AC/DC(等效).
4. 接触电阻: ≤0.03Ω.
5. 绝缘电阻: >500MΩ

Part No	Pin	A	B	C
FC-10A2P11H20	2	1.00	3.10	6.90
FC-10A3P11H20	3	2.00	4.10	7.90
FC-10A4P11H20	4	3.00	5.10	8.90
FC-10A5P11H20	5	4.00	6.10	9.90
FC-10A6P11H20	6	5.00	7.10	10.90
FC-10A7P11H20	7	6.00	8.10	11.90
FC-10A8P11H20	8	7.00	9.10	12.90
FC-10A9P11H20	9	8.00	10.10	13.90
FC-10A10P11H20	10	9.00	11.10	14.90
.....
FC-10A32P11H20	32	(32-1)*1.0	(32+6)*1.0+0.10	(32+6)*1.0-0.10

5

GENERAL TOLERANCE	DONGGUAN BAOXUN PRECISION TECHNOLOGY CO., LTD					
DIM. TOL.	TITLE: 1.0 Pitch 前翻卧式下接 (H=2.0)					
X	DWG. NO.: FC-10ANP11H20			DRAWN: MAX		
X.X ±0.30	PART NO.: FC-10ANP11H20			CHECKED: ELLA		
X.XX ±0.25	UNIT: mm			APPROVED: WILL		
X.XXX ±0.15	SCALE: none	SHEET: 1 of 1	DWG. SIZE: A4	LAYER: bxconn		
GENERAL ANGLE: ±3°						

X-ON Electronics

Largest Supplier of Electrical and Electronic Components

Click to view similar products for [FFC & FPC Connectors](#) category:

Click to view products by [BXCONN](#) manufacturer:

Other Similar products are found below :

[00-6200-227-022-800](#) [006205250500825+](#) [006205280500825+](#) [FPH-1602G](#) [086222026001800](#) [52610-0675](#) [62674-201121DLF](#) [52746-1671-TR250](#) [10051922-1610EHLF](#) [10051922-2810EHLF](#) [686322124422](#) [XF3M-2915-1B-R100](#) [AYF353125A](#) [AYF530665TA](#) [AYF534065TA](#) [20FLH-RSM1-TB](#) [PCA-7F-25-HL-3-G](#) [207356-1](#) [52807-0430](#) [FFC05011-10SBB114W5M](#) [502250-8027](#) [FH28K-40S-0.5SH](#) [200528-0260](#) [FH28K-10S-0.5SH](#) [501951-1250](#) [X05B20U43T](#) [0.5K-DX-30PWB](#) [DS1020-08-10VBT12](#) [THD0515-34CL-GF](#) [X05A10L28G](#) [ECC2841061EU](#) [1.0K-DHQX-16PWB](#) [1.0K-DHQX-30PWB](#) [1775333-6](#) [10054365-202110ELF](#) [10054365-242110ELF](#) [10054365-282110ELF](#) [10064555-392220HLF](#) [59453-041110EBHLF](#) [59453-091110EDHLF](#) [62674-241141ALF](#) [62684-432100ALF](#) [62684-451100AHLF](#) [62684-5721N0ALF](#) [HFW11R-1STE1MTLF](#) [HFW12R-1STE9LF](#) [HFW14R-1STE9MTLF](#) [HFW18S-2STE9LF](#) [HFW20R-1STAE1HLF](#) [HFW20R-1STE1MTLF](#)